

MODEL 86

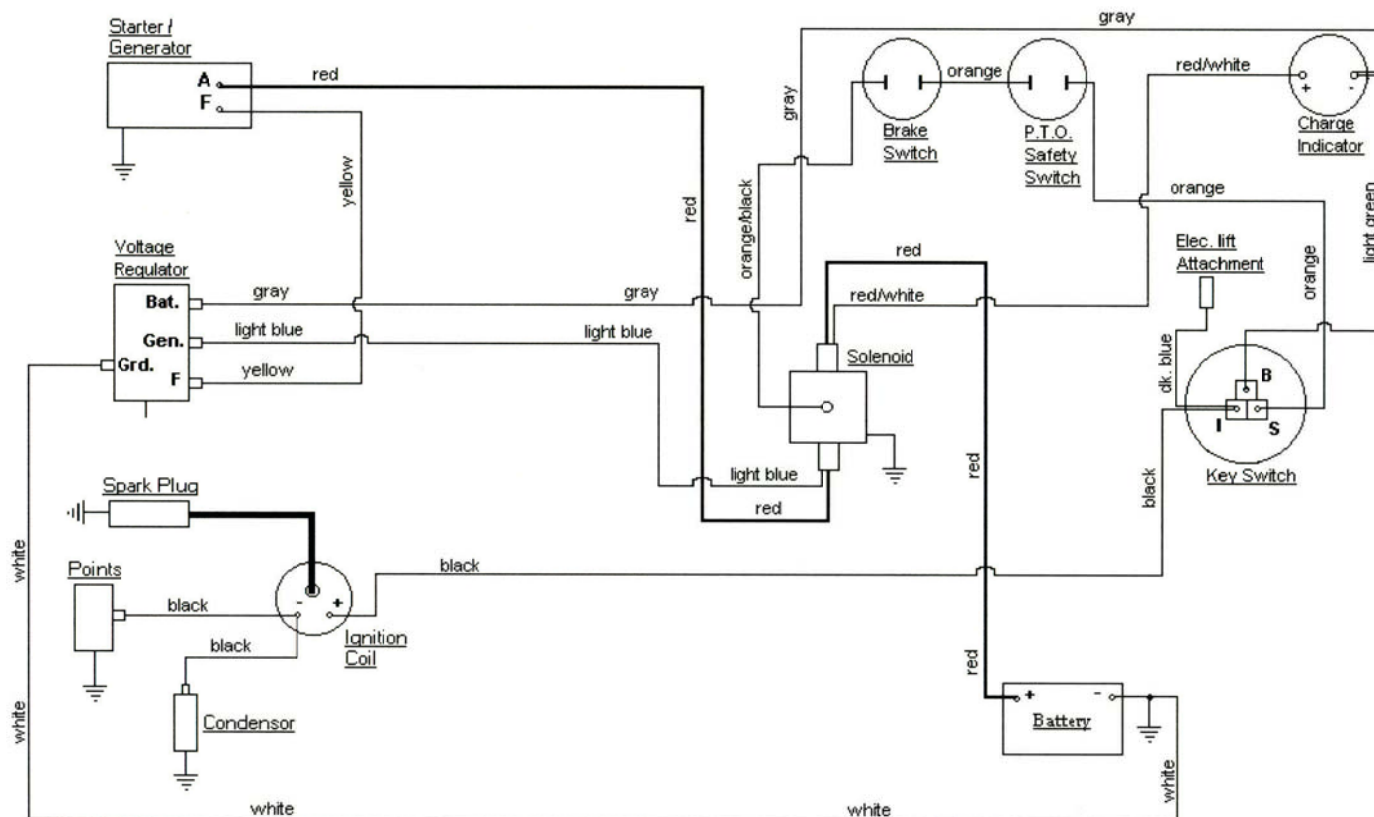

KEY SWITCH	
OFF	B
ON	B+I
START	B+S

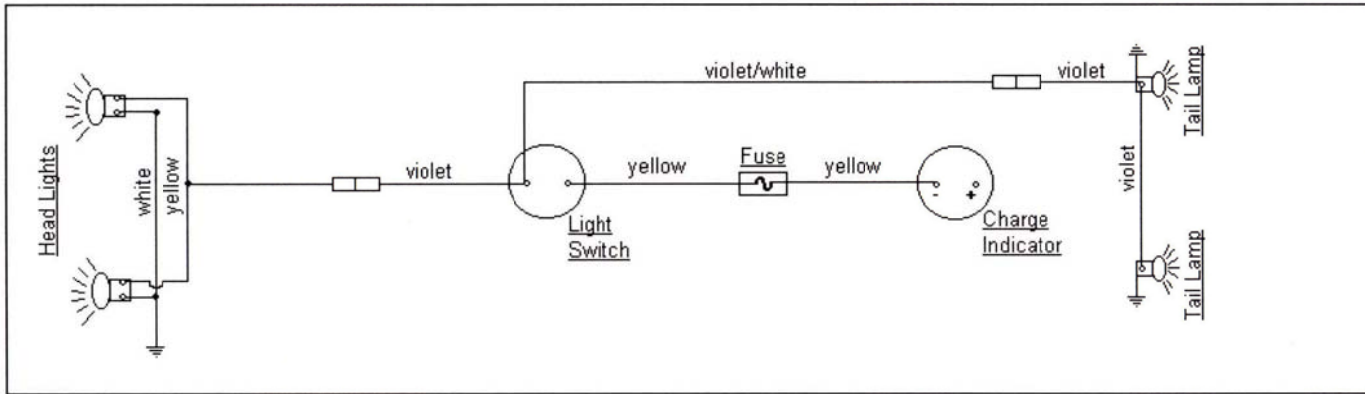

Electric Lighting Wiring Diagram.

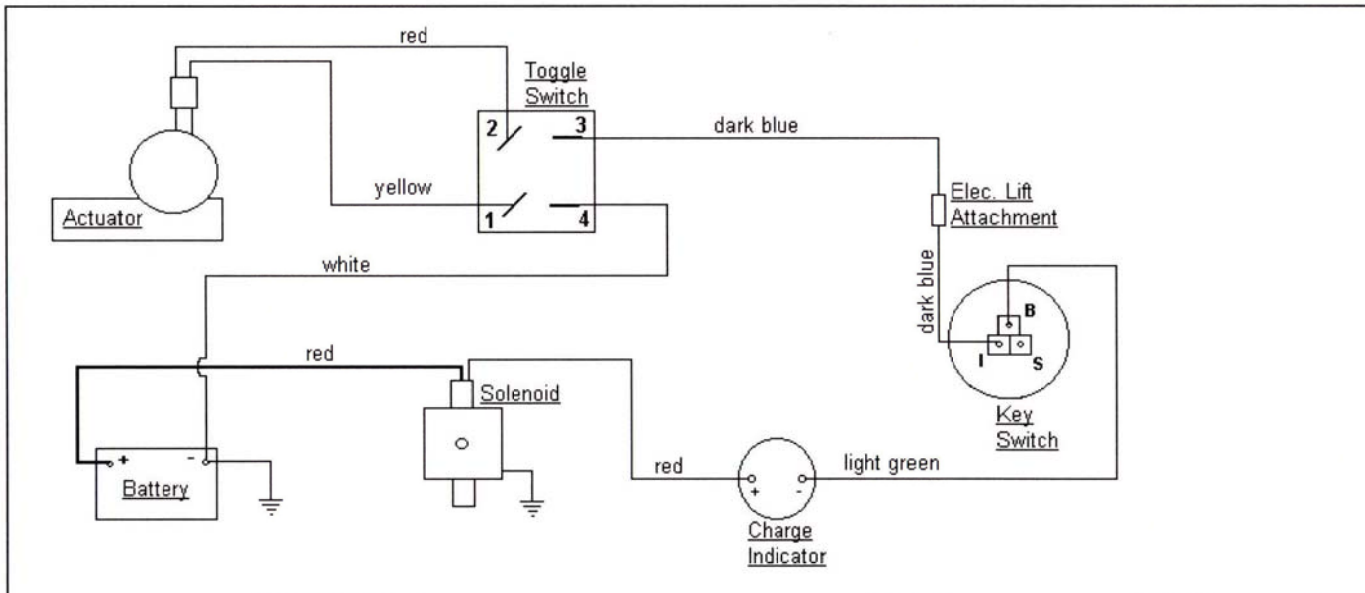

Electric Lift Wiring Diagram.