

MODEL 108

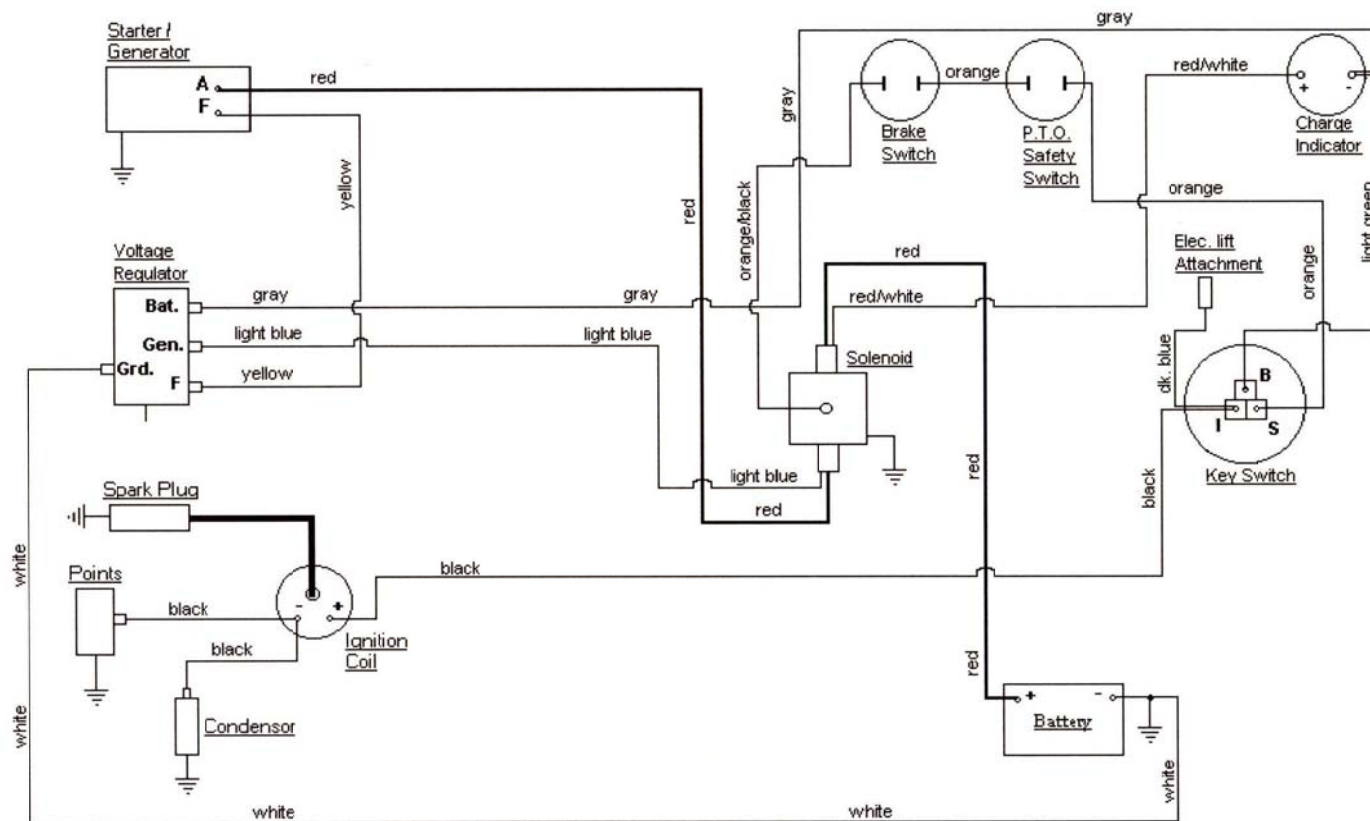

KEY SWITCH

OFF	B
ON	B+I
START	B+S

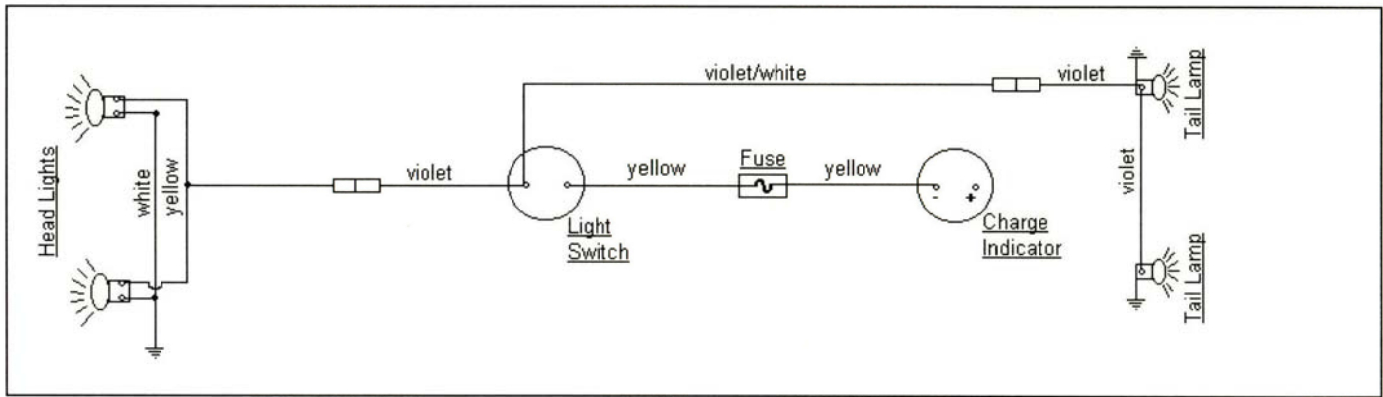

Electric Lighting Wiring Diagram.

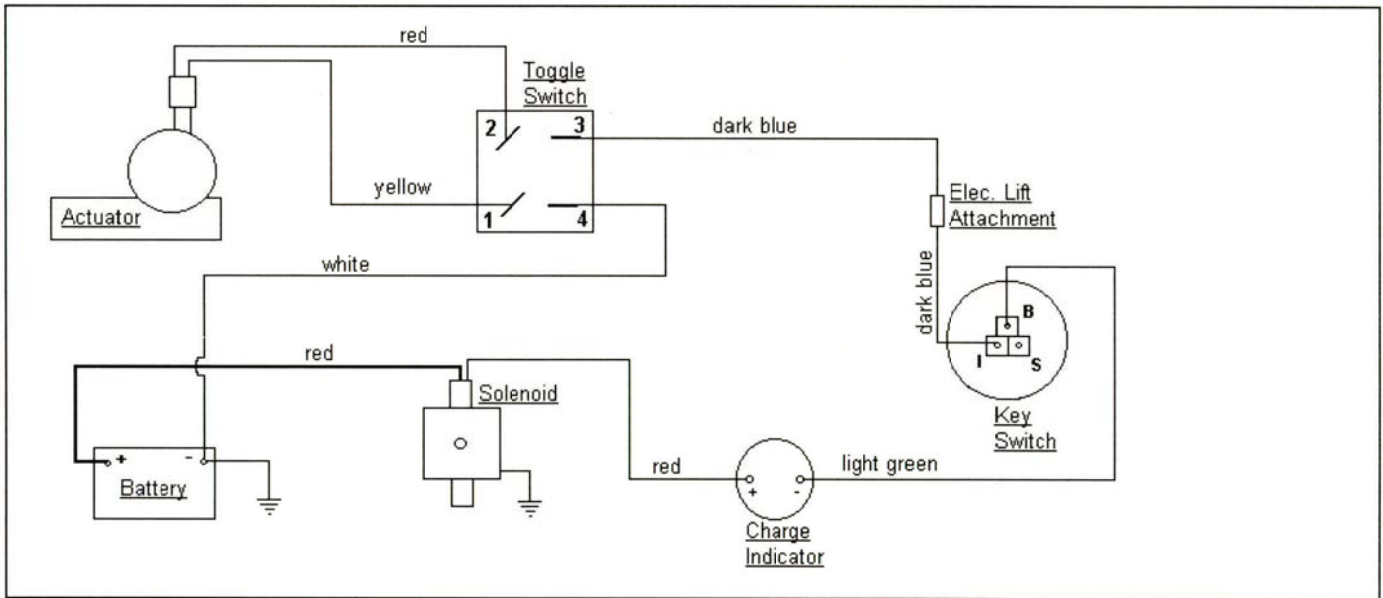

Electric Lift Wiring Diagram.