

The logo for Cub Cadet, featuring the brand name in a white, stylized script font on a blue rectangular background.

Service Manual



1000/1500 Series Riding Tractors

NOTE: These materials are for use by trained technicians who are experienced in the service and repair of outdoor power equipment of the kind described in this publication, and are not intended for use by untrained or inexperienced individuals. These materials are intended to provide supplemental information to assist the trained technician. Untrained or inexperienced individuals should seek the assistance of an experienced and trained professional. Read, understand, and follow all instructions and use common sense when working on power equipment. This includes the contents of the product's Operators Manual, supplied with the equipment. No liability can be accepted for any inaccuracies or omission in this publication, although care has been taken to make it as complete and accurate as possible at the time of publication. However, due to the variety of outdoor power equipment and continuing product changes that occur over time, updates will be made to these instructions from time to time. Therefore, it may be necessary to obtain the latest materials before servicing or repairing a product. The company reserves the right to make changes at any time to this publication without prior notice and without incurring an obligation to make such changes to previously published versions. Instructions, photographs and illustrations used in this publication are for reference use only and may not depict actual model and component parts.

© Copyright 2006 MTD Products Inc. All Rights Reserved

MTD Products Inc. - Product Training and Education Department

FORM NUMBER - 769-02100

1/2006

Table of Contents

1.	INTRODUCTION	1
2.	NEW HOOD DESIGN	3
3.	HOOD PANEL REMOVAL: 1500 SERIES	5
4.	HOOD AND HINGE REMOVAL: 1500 SERIES	6
5.	REAR FENDER REMOVAL	7
6.	FUEL SYSTEM	9
7.	FUEL SHUT-OFF SOLENOID	11
8.	FUEL RELATED NO-START ISSUES	11
9.	MUFFLER REMOVAL	12
10.	CUTTING DECK REMOVAL	13
11.	DECK LIFT SHAFT ASSEMBLY	15
12.	LIFT SHAFT BUSHINGS	16
13.	DECK LIFT CABLES AND PULLEYS	17
14.	LEVELING THE CUTTING DECK	18
15.	DASH PANEL REMOVAL	20
16.	CRUISE CONTROL AND PARK BRAKE LINKAGES	22
17.	TRACTION DRIVE BELT REPLACEMENT: CVT	24
18.	DRIVE SYSTEM ADJUSTMENT: CVT	27
19.	BRAKE ADJUSTMENT: CVT	30
20.	SERVICING THE BRAKE PEDAL SHAFT BUSHINGS:	32
21.	TRANSAXLE REPLACEMENT: CVT	34
22.	TRANSAXLE SERVICE AND INTERNALS: CVT	36
23.	TRACTION DRIVE BELT REPLACEMENT: HYDROSTATIC LT	36
24.	DRIVE SYSTEM ADJUSTMENT: HYDROSTATIC LT	39
25.	HYDRO CONTROL ROD ADJUSTMENT	42
26.	BRAKES AND BRAKE ADJUSTMENT: HYDROSTATIC LT	43
27.	PEDAL BUSHING REPLACEMENT	46
28.	TRANSAXLE SERVICE AND MAINTENANCE: HYDROSTATIC LT	47
29.	TRANSAXLE REPLACEMENT: HYDROSTATIC LT	49
30.	TRACTION DRIVE BELT REPLACEMENT: HYDROSTATIC GT	52
31.	DRIVE SYSTEM ADJUSTMENT: HYDROSTATIC GT.....	54
32.	BRAKES AND BRAKE ADJUSTMENT: HYDROSTATIC GT	58
33.	TRANSAXLE SERVICE AND MAINTENANCE: HYDROSTATIC GT	62
34.	TRANSAXLE REPLACEMENT: HYDROSTATIC GT	64
35.	STEERING GEAR AND STEERING PINION GEAR REPLACEMENT	67
36.	STEERING ADJUSTMENT / ALIGNMENT	68
37.	PIVOT BAR SERVICE	69
38.	ELECTRICAL SYSTEM	71
39.	UNDERSTANDING THE PTO SWITCH	77

Series 1000 and 1500

1. INTRODUCTION



Disclaimer: This service manual is intended to be used by trained technicians.

Disclaimer: The information contained in this manual is current and accurate at the time of writing, but is subject to change without notice.

1.1. **Intent:** This manual is intended to:

- Provide specific service and repair procedures for a range of Cub Cadet 1000 and 1500 Series tractors manufactured for the 2005/2006 season.
- Highlight significant changes to the Cub Cadet 1000 Series since its introduction.

1.2. **Engines:** A variety of single cylinder and V-twin engines have been used in the 1000 series tractors. Kohler Courage line of single-cylinder and V-Twin engines is presently the most heavily used power source in the 1000 Series line

1.3. For specific engine service information, refer to the engine manufacturer's service publications.

1.4. The engine is partially identified by the 4th digit of the factory number:

- 13AX11CG756 - Kohler Courage single cylinder
- 13AP11CP756 - Kohler courage V-Twin

1.5. Refer to the table provided for engine applications in the 1000 series range. See Figure 1.5.

1000 Series Engine Applications			
Year	Model #	Factory #	Engine
2001	1027	13A-328-101	9.0 HP BS
	1170	13CD608G101	17.5 HP BS
	1180	13AT608H101	18 HP BS
	1212	14AJ808H101	21 HP BS
2002	1027	13A-328-101	9.0 HP BS
	1170	13CD608G101	17.5 HP BS
	1515	13A-201F100	15 HP KOH
	1517	13A-231G100	17 HP KOH
2003	1525	13A-221F100	15 HP KAW
	1527	13A-241G100	17 HP KAW
	1529	13A-261H100	19 HP KAW
2004	LT 1018	13AL11CG710	18.5 HP BS
	LT 1022	13AB11CH710	22 HP BS
	LT 1024	13AR11CP710	24 HP BS
	GT 1222	14AB13CH710	22 HP BS
2005	LT 1042	13BX11CG710	19 HP KOH
	LT 1045	13AX11CH710	20 HP KOH
	LT 1046	13AP11CH710	23 HP KOH
	LT 1050	13AQ11CP710	26 HP KOH
	SLT 1554	13AK11CK710	27 HP KOH
2006	LT 1042	13AX11CG756	19 HP HOH
	LT 1045	13AX11CH756	20 HP KOH
	LT 1050	13AP11CP756	23 HP KOH
	SLT 1550	13AQ11BP756	25 HP KOH
	GT 1554	14AK13BK756	27 HP KOH

Figure 1.5

Series 1000 and 1500

- 1.6. **Decks:** Cutting decks ranging in width from 38" to 54" have been used on the 1000 Series platform.
- 1.7. There have been multiple versions of some decks, most particularly the 42". Check the serial number when researching for parts or service information.
- 1.8. The deck size is identified by the 8th digit of the factory number: See Figure 1.8.

1000 Series Deck Applications			
Year	Width	Deck	Deck/PTO Belts
2001	27.5"	CYB/STD	754-0754
	42"	G	754-0472
	46"	H	754-0349/754-0476
2002	27.5"	CYB/STD	754-0754
	42"	G	754-0472
	38"	F	754-0641
	42"	G	754-0645/754-0644
2003	38"	F	754-0641
	42"	G	754-0645/754-0644
	46"	H	754-04011
2004	42"	G	754-0498/754-0499
	46"	H	754-04033
	50"	P	754-04048
2005	42"	G	754-04060B
	46"	H	754-04033
	50"	P	754-04077
	54"	K	754-0642
2006	42"	G	754-0349
	46"	H	754-0349
	50"	P	754-0349
	54"	K	754-0349

Figure 1.8

- 13AX11CG756 - 42" 2-blade deck
- 13AX11CH756 - 46" 3-blade deck
- 13AP11CP756 - 50" 3-blade deck
- 13AQ11BP756 - 50" 3-blade deck
- 14AK13BK756 - 54" 3-blade deck

- 1.9. **Drive Systems:** A variety of hydrostatic and CVT drive systems have been used on the 1000 Series tractors.
- 1.10. A Two-belt CVT system driving an MTD single-speed transaxle is presently used only on the LT1040 model. This system can be distinguished by the gear selector (F-N-R) on the left rear fender, and the simple drive pedal. See Figure 1.10.



Figure 1.10

- 1.11. A similar two-belt CVT system was employed to drive a heavy-duty transaxle in some 2002 and 2002 models having two forward speed ranges. These are easy to identify by the presence of the gear selector lever between the operators knees rather than on the fender.
- 1.12. All CVT driven 1000 and 1500 Series tractors have a gear selector lever and a drive pedal on the right side, near the brake pedal.
- 1.13. All Hydrostatic transaxles on the 1000 and 1500 Series are operated by a rocker pedal on the right side, near the brake pedal.
- 1.14. A Hydro-Gear 310-0510 hydrostatic transaxle is used on LT models having 20" rear tires. Hydrostatic transaxles have a rocker pedal to control forward and reverse direction and speed.

- 1.15. A Hydro-Gear 314-0610 hydrostatic transaxle with a different final drive ratio is used on LT models having 22" rear tires. Hydrostatic transaxles have a rocker pedal to control forward and reverse direction and speed. See Figure 1.15.



Figure 1.15

- 1.16. A Hydro-Gear 320-3000 hydrostatic transaxle is used on GT designated models. This is a substantially heavier duty IHT than the one used in the LT models. Hydrostatic transaxles have a rocker pedal to control forward and reverse direction and speed. See Figure 1.16.



Figure 1.16

2. NEW HOOD DESIGN

- 2.1. Early 1000 and 1500 Series tractors used a variety of steel hoods and side panels. Later ones resembled those used on the 2000 and 2500 Series tractors.
- 2.2. The hood presently used on the 1000 series tractors is a molded 1-piece design. See Figure 2.2.



Figure 2.2

- 2.3. The 1000 Series hood opens from the back. See Figure 2.3.



Figure 2.3

Series 1000 and 1500

2.4. The 1000 Series hood can be easily removed: See Figure 2.4.



Figure 2.4

- Disconnect the headlight wires
- Release the retaining springs
- Align the bolts in the hood with the slots in the hinge.
- Lifting the hood off of the tractor.

2.5. The hood used on the 1500 Series tractors for 2005 and 2006 is more substantial than that used on the 1000 Series. It is a one-piece molded design very similar to the one used on the much larger 5000 and 6000 series tractors. See Figure 2.5.



Figure 2.5

- It opens from the front.

- A pair of gas charged cylinders provide lift assist. See Figure 2.5.

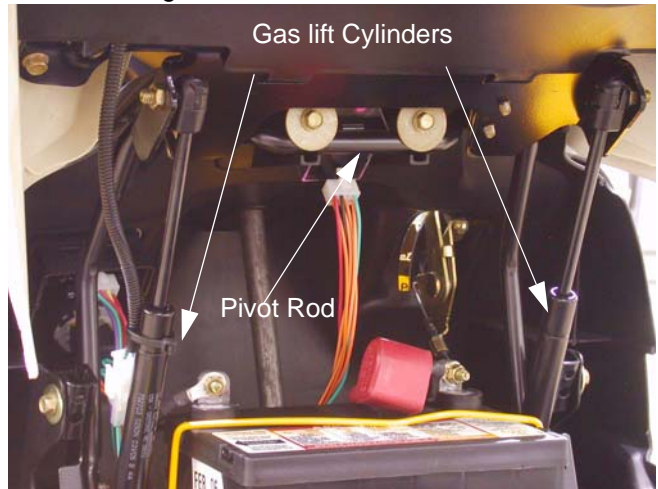

Figure 2.5

2.6. A new spring-loaded latch was added to hold the hood closed. See Figure 2.6.



Figure 2.6

- 2.7. A torsion spring keeps the latch secure until the lower pivot latch is intentionally pulled up, to open the hood. See Figure 2.7.

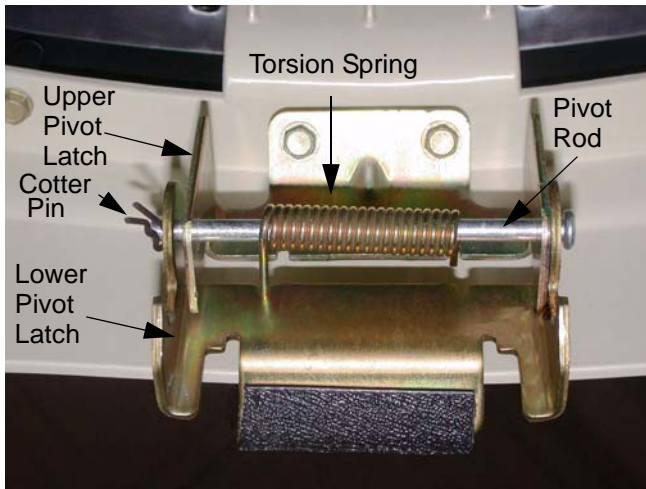

Figure 2.7

- 2.8. The hood latches to a sturdy rod that is mounted to the front of the frame. See Figure 2.8.

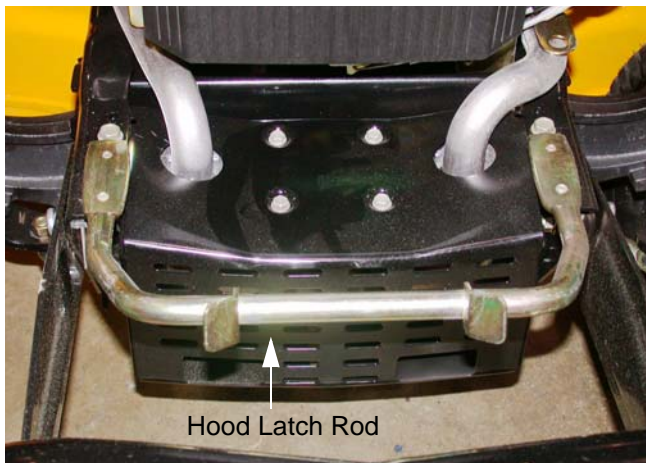

Figure 2.8

3. HOOD PANEL REMOVAL: 1500 SERIES

NOTE: Use this procedure if the hood alone is to be removed. Typical reasons might include replacement because of damage to the hood, or to ease access for other service.

- 3.1. Disconnect ground cable from battery using a 7/16" wrench.

- 3.2. Disconnect headlight harness (plugged secured to hood lift cylinder). See Figure 3.2.



Figure 3.2

- 3.3. Remove the air deflector baffle using a 3/8" wrench. See Figure 3.3.



Figure 3.3

- 3.4. Support the hood as it is being loosened.
3.5. Separate hood from hinge using a 3/8" wrench.
3.6. Lift hood off of tractor.

Series 1000 and 1500

4. HOOD AND HINGE REMOVAL: 1500 SERIES

NOTE: Use this procedure for more extensive repairs. Typical reasons may include dash panel removal, or the need for more working room than simply removing the hood will provide.

4.1. Remove the battery: See Figure 4.1.



Figure 4.1

- Disconnect the negative battery cable (black) first, using a 7/16" wrench.
 - Disconnect the positive battery cable (red) using a 7/16" wrench.
 - Remove the battery hold-down.
 - Lift the battery from the tractor.
- 4.2. Disconnect the headlight harness. (Plug secured to the hood lift cylinder).
- 4.3. Support the hood with an improvised prop-rod to prevent damage.
- 4.4. Remove screws holding hinge support bar to dash support using a 1/2" wrench.
- 4.5. Disconnect and remove the hood lift cylinders using a small straight-blade screwdriver.
- 4.6. Remove screws & flat washers holding hinge support bar to dash panel using a 3/8" wrench.
- 4.7. Lift hood and hinge assembly off of the tractor, and remove it to a safe place.

4.8. Hood installation notes: See Figure 4.8.

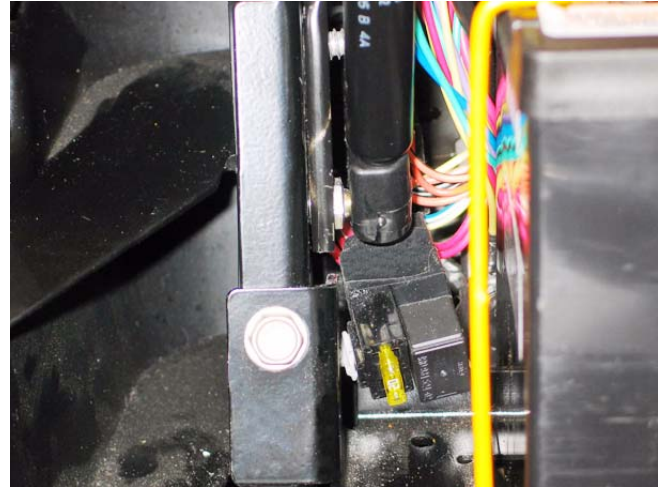

Figure 4.8

- Position the hinge support bar over the two spacers that partially cover the threads of the balls that the hood support struts attach to. The slots in the ends of the bar will fit over the spacers.
- Support the hood with an improvised prop rod.
- Install the screws that hold the hinge support bar to the dash support and instrument panel.
- Snap the hood support cylinder into place, and remove the prop rod.
- The remainder of the installation process is simply the reversal of the removal steps.

5. REAR FENDER REMOVAL

5.1. It is necessary to remove the fender assembly for access to the following service areas: See Figure 5.1.



Figure 5.1

- Fuel tank (hydrostatic drive riders)
- Lift-shaft assembly (except bushings)
- Deck lift cable removal
- Wiring harness inspection or removal
- Dash panel removal
- Traction drive belt idler pulley removal
- Traction drive belt tension arm removal

NOTE: At first-glance, fender removal appears to be a substantial job. Skilled mechanics can typically remove the fenders from a 1000 Series Cub Cadet tractor in about 15 minutes, with an equal amount of time required for installation.

5.2. Disconnect the ground cable from the negative battery post using a 7/16" wrench.
5.3. Remove the cutting deck from the tractor.

5.4. Remove the rubber grip from the cutting deck height control handle atop the right rear fender. See Figure 5.4.



Figure 5.4

5.5. Disconnect the two yellow wires from the seat safety switch mounted to the left side seat bracket. See Figure 5.5.

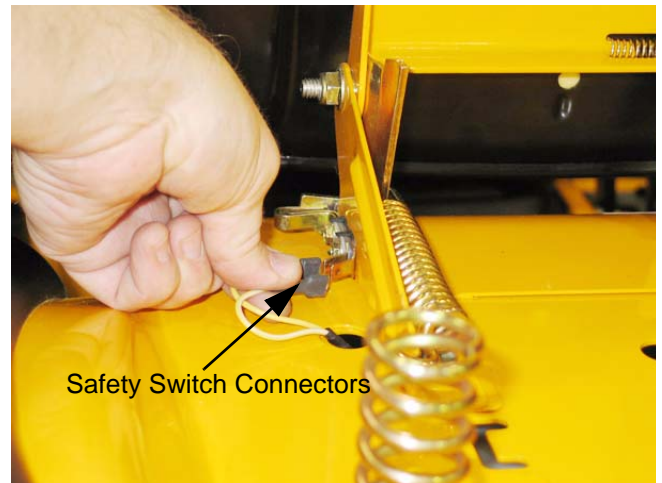

Figure 5.5

5.6. Release the gold colored extension spring from the left side seat bracket using a length of starter rope or a spring removal tool.

- gold colored spring: left seat bracket
- red spring: right seat bracket
- Only the gold colored spring must be removed because it blocks access to the bolts that hold the seat bracket to the frame.

Series 1000 and 1500

- 5.7. Remove the four bolts that hold the seat brackets to the frame using a 1/2" wrench.
- 5.8. Remove the seat to a safe location.
- 5.9. Remove the hydro control pedal (or speed control pedal on CVT equipped models) using a T-40 driver. See Figure 5.9.

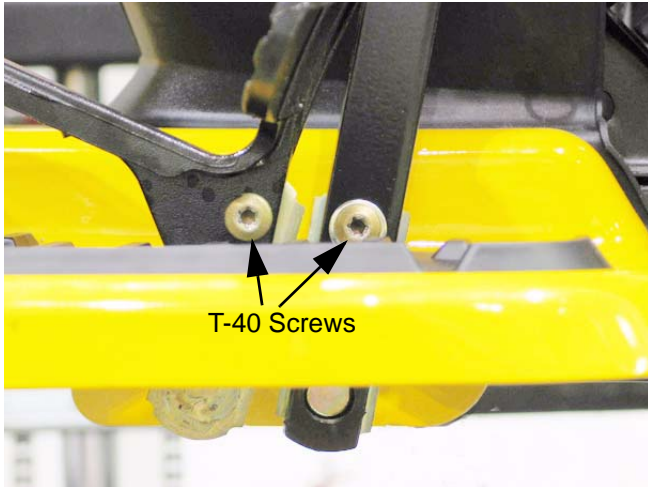

Figure 5.9

- 5.10. Remove the brake pedal using a T-40 driver (upper screw) and a 9/16" wrench (lower screw).
- 5.11. Remove the nuts from the carriage bolts that secure the front edge of each running board to the frame bracket that supports it. See Figure 5.11.



Figure 5.11

- Apply thumb pressure to the rubber foot pad, directly above the nut / carriage bolt to hold the square boss on the nut into the bracket, to prevent rotation.

- 5.12. Peel-back the rubber foot pad to reach and remove the carriage bolt. See Figure 5.12.



Figure 5.12

- 5.13. Carefully peel-up each rear corner of the larger instruction label located between the foot pads, revealing two screws that hold the fender assembly to the frame. See Figure 5.13.



Figure 5.13

NOTE: If the previous steps are done with care, the label can be reapplied, using some spray-on contact adhesive if necessary.

- If the label shows signs of becoming damaged by the peeling-back process, it should be replaced during reassembly.
- To identify and order a replacement label, note the number printed on the lower right corner of the label ("S32484 AC" typical). That number, with a 777 prefix (**777-S32484 AC**) is usually the part number of the label.

- 5.14. Remove the two screws that were revealed by peeling-back the label. This can be done using a 3/8" wrench. See Figure 5.14.



Figure 5.14

- 5.15. Remove the fuel filler cap.
5.16. Lift the fenders off of the tractor, maneuvering them to clear the cutting deck height control lever. See Figure 5.16.



Figure 5.16

- 5.17. Remove the fenders to a safe place.
5.18. Replace the fuel filler cap.
5.19. Installation notes:
- Confirm that the seat safety switch wires are accessible before securing the fender.
 - 144 in-lbs is adequate tightening torque for the 5/16"-18 screws and bolts removed in this procedure. (1/2" wrench or T-40 driver)

- When installing a large panel, start all of the threaded fasteners, then go back and tighten each after the panel is in position.
- Test the operation of all controls and safety features in a safe place, free of obstacles and bystanders before returning the tractor to service.

6. FUEL SYSTEM

- 6.1. While the 1000 and 1500 Series tractors are built on the same frame, the fuel systems differ substantially in layout.
- 6.2. The 1000 Series tractors have the fuel tank beneath the hood, with the battery located under the seat. See Figure 6.2.



Figure 6.2

- 6.3. This positioning is necessary to provide easy service access to the CVT drive system used on the 1000 series tractors. The rear mounted battery, and the tray that supports it are easily removable.
- 6.4. The battery of the 1500 Series tractor is located under the hood, with the fuel tank mounted under the rear fenders.

Series 1000 and 1500

- 6.5. On current models of the 1000 and 1500 Cub Cadet, the fuel is moved from the tank to the carburetor by a vacuum-driven fuel pump that is mounted to the engine. See Figure 6.5.

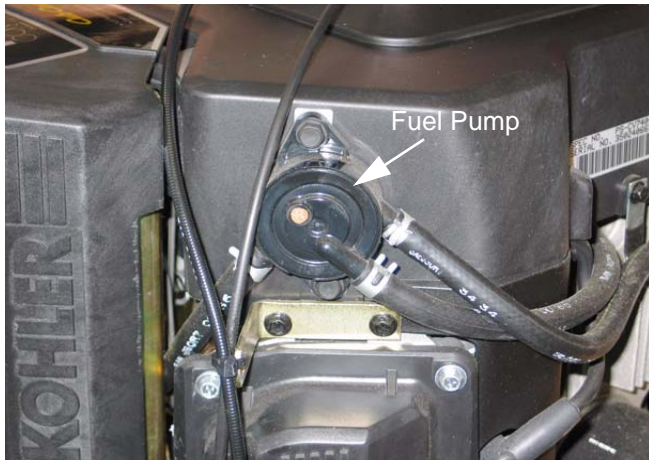

Figure 6.5

- 6.6. The fuel line runs from a barbed fitting on the bottom of the fuel tank to the fuel pump.
- 6.7. The 1500 series fuel line should be routed as shown. See Figure 6.7.

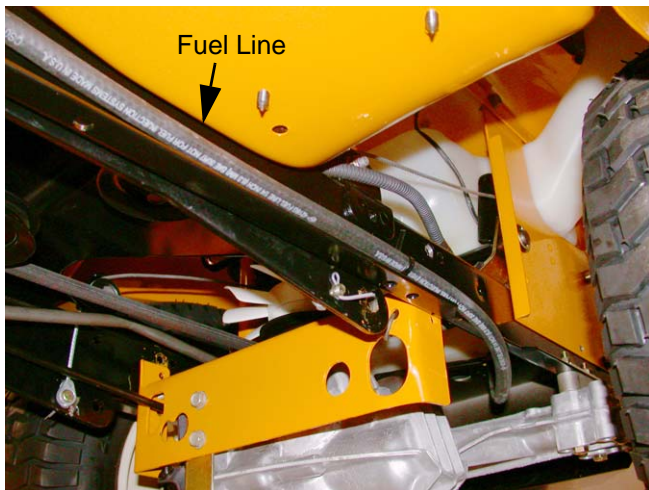

Figure 6.7

- 6.8. The fuel cap is vented.
- There are a few non-vented fuel caps that will fit the filler neck of the 1000 and 1500 Series tractor.
 - Non-vented caps are used on the Cub Cadet Big Country line of utility vehicles.
 - Use of a non-vented cap on a 1000 or 1500 Series tractor will cause fuel supply issues.

- 6.9. In the event that it is necessary to remove the fuel tank, begin by removing the fenders as described in the REAR FENDER REMOVAL section of this manual.
- 6.10. Make provisions for draining any fuel that remains in the gas tank: 24" of 1/4" fuel line, and a suitable catch pan will be sufficient.
- 6.11. Pinch the fuel line about 6" from the fuel tank to prevent the line from emptying (unless it needs to be drained or replaced).
- Position the catch pan under the fitting on the fuel tank.
 - Have the extra length of fuel line handy.
- 6.12. Remove the hose clamp that secures the fuel line to the fitting on the gas tank. See Figure 6.12.



Figure 6.12

- 6.13. Quickly pull the fuel line off of the fitting, and replace it with the extra hose. Direct the hose into the catch pan.
- 6.14. When the tank is empty, dispose of any unusable fuel in a safe and responsible manner.

- 6.15. Remove the plate that supports the seat brackets using a 1/2" wrench. See Figure 6.15.

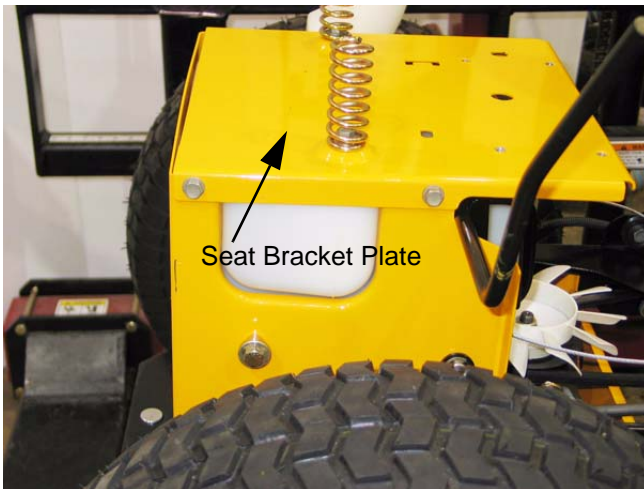

Figure 6.15

- 6.16. Lift the fuel tank out of the tractor.

7. FUEL SHUT-OFF SOLENOID

- 7.1. In all models of the 1000 and 1500 Series Cub Cadet riders, there is a fuel shut-off solenoid mounted to the carburetor. See Figure 7.1.

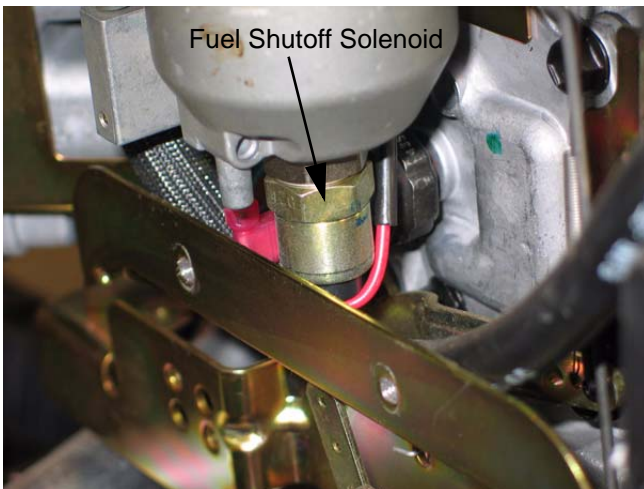

Figure 7.1

- 7.2. The fuel shut-off solenoid is a valve that is actuated by an electric coil.
- The fuel shut-off solenoid helps prevent “after-boom” when a hot engine is turned-off.
 - The solenoid has power when the key is in the run position and the safety switches on the tractor do not sense any unsafe conditions. When it has power, the solenoid opens, allowing fuel to reach the carburetor.

- When the solenoid does not have power, it closes, stopping the flow of fuel.
- The solenoid usually emits an audible “click” when power is applied or discontinued.
- If the solenoid does not click, it is not working. If it does click, it cannot be assumed to be working properly.

8. FUEL RELATED NO-START ISSUES

- 8.1. The leading industry cause of no-start and engine performance problems is stale or outdated fuel.
- In temperate regions of the country, fuel purchased during the summer may not be volatile enough to ignite during the winter months.
 - Similarly, “Winter” fuel may cause performance issues if used into the summer months. The gasoline companies tailor the contents of their fuel blends to optimize performance, taking climate and geography into account.
 - As fuel goes stale, the lighter end hydrocarbons (more volatile elements) tend to evaporate, leaving the fuel less volatile.
 - In extreme cases, semi-solid residue will accumulate, damaging the fuel system.
 - If a piece of equipment will sit unused during the dormant season, the fuel system should be drained completely, or preservative should be added to the fuel according to the preservative manufacturer’s instructions.
- 8.2. Alcohol content of the fuel should not exceed 10%.
- Small amounts of ethanol are fairly common in fuel.
 - Methanol is more destructive than ethanol, and should be avoided.
 - Alcohol absorbs water. Fuel that contains alcohol will also contain a certain amount of water. The water will corrode any metallic parts of the fuel system, and may cause freezing damage in low temperatures.
 - Products that purport to “dry” the fuel system are generally isopropyl alcohol. The object is to re-suspend the water that has settled out of the alcohol the fuel already contains.

Series 1000 and 1500

- Ether-based starting fluids should not be used, and may void engine warranties if their use is detected.

9. MUFFLER REMOVAL

NOTE: There are a variety of mufflers on this series of tractor depending on the year and engine of the unit. This chapter will cover a few different mufflers to give you the basics of muffler removal on this series.

NOTE: For all tractors, remove the bumper first.

- **On units with side panels:**

9.1. Remove the hood, side panels and grill.

NOTE: Make sure to disconnect the headlight harness when you remove the grill and side panels.

9.2. Remove the self tapping hex cap screws securing the front frame assembly to the muffler shield and muffler using a 1/2" socket. See Figure 9.2.

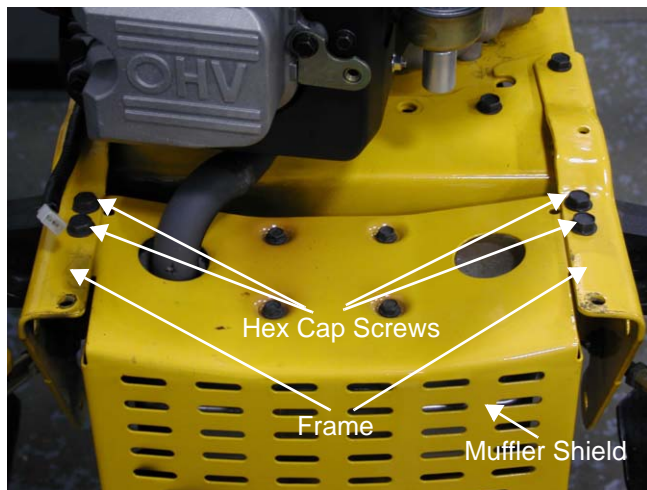

Figure 9.2

9.3. Remove the muffler and guard.

NOTE: Muffler slides off of the exhaust pipe. It is NOT fastened to the pipe.

9.4. Remove the four screws in the top of the muffler guard. The muffler and muffler guard will now separate.

9.5. Reassemble in reverse order.

- **1000 Series with one piece hood.**

9.6. Remove hood as shown in section 2.

9.7. Remove both hinge brackets. See Figure 9.7.



Figure 9.7

9.8. Remove the four screws in the sides of the muffler guard. Slide the muffler and muffler guard off of the exhaust pipe(s). See Figure 9.8.

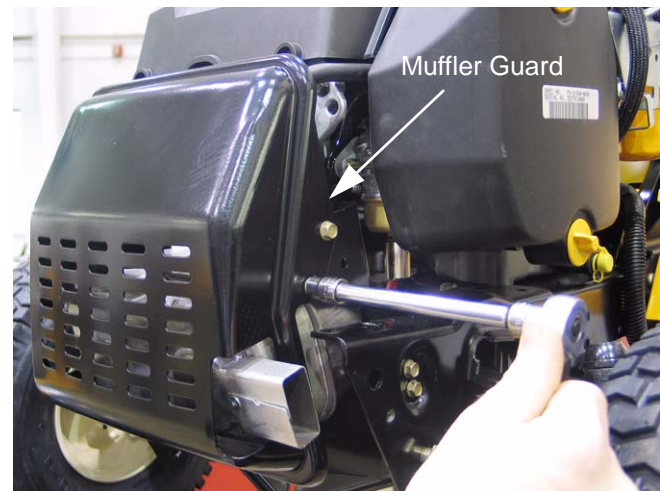

Figure 9.8

NOTE: You may have the tail pipe sticking out of the left side. If so slide the guard off of it first.

- 9.9. Remove the four screws going through the muffler support brackets into the muffler mounting bracket. See Figure 9.9.



Figure 9.9

- 9.10. The muffler will now slide off of the exhaust pipe(s).
- 9.11. Remove the screws in the muffler mounting brackets and lift the brackets off of the muffler.
- 9.12. Reassemble in reverse order.
- **1500 with one piece hood:**
- 9.13. Open hood.
- 9.14. Remove bumper
- 9.15. Remove the two clevis pins in the deck front stabilizer bracket.

- 9.16. Remove the four screws holding the muffler guard to the front muffler support brackets. See Figure 9.16.



Figure 9.16

NOTE: The rear two screws will be accessible from the top. the front two screws will be accessible from the bottom.

- 9.17. Slide the muffler and muffler guard off of the exhaust pipe(s).
- 9.18. Remove the four screws in the top of the muffler guard. Lift the muffler guard off of the muffler.
- 9.19. Reassemble in reverse order.

10. CUTTING DECK REMOVAL

- 10.1. Place the PTO switch in the off position.
- 10.2. Lower the lift lever to the lowest setting.

Series 1000 and 1500

- 10.3. Remove the PTO belt from electric PTO clutch. See Figure 10.3.

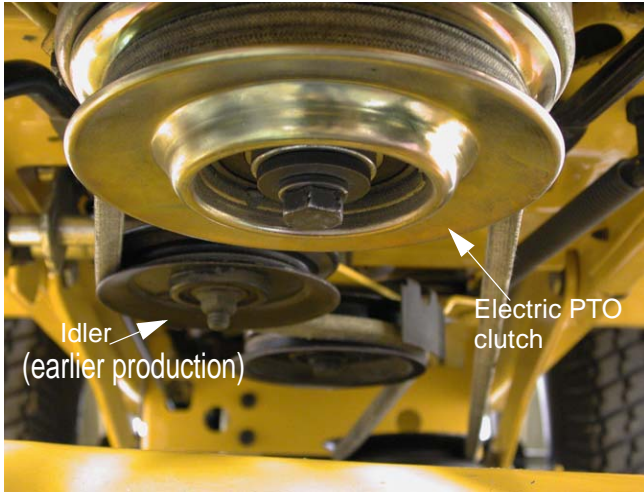

Figure 10.3

NOTE: On some models you will need to remove the belt guide first.

NOTE: On earlier production models you need to slip the belt off of the idler pulley before you remove the belt from the PTO clutch.

- 10.4. Pull the rear deck support pins outward from the deck lift arms. See Figure 10.4.

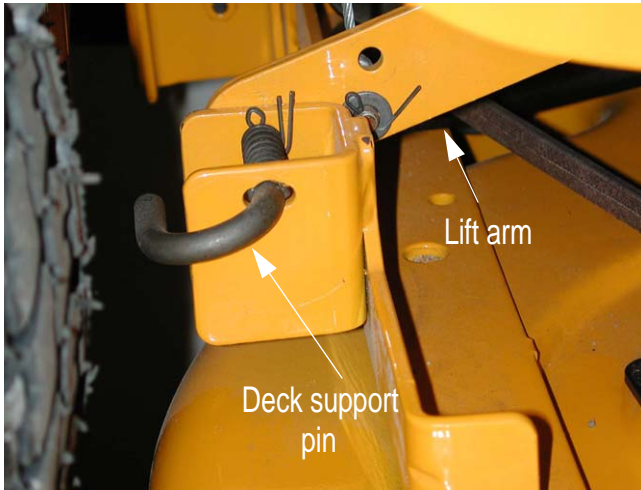

Figure 10.4

- 10.5. Pivot the deck support pins to the rear.
- 10.6. Raise the lift lever to the highest setting. This will raise the lift arms up and out of the way of the deck assembly.

- 10.7. Slide the deck forward and release the front stabilizer rod. DO NOT DROP the deck to the ground. See Figure 10.7.

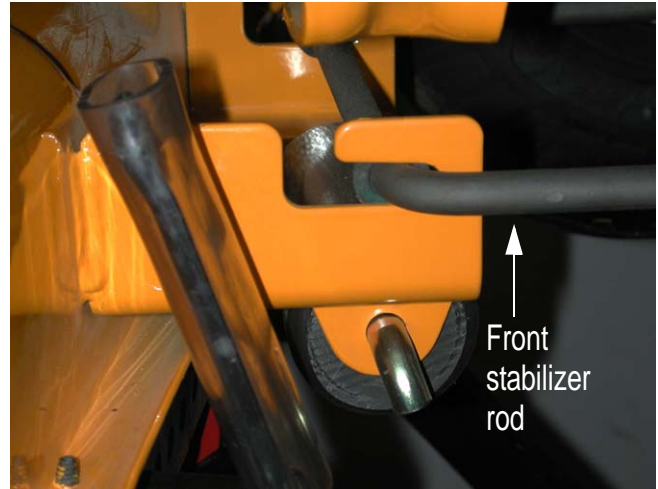

Figure 10.7

- 10.8. Slide the deck toward the right side of the tractor and remove it from under the tractor.

CAUTION: Remove the deck stabilizer assembly from the tractor prior to moving the unit.

NOTE: Depending on the model and deck, some units have a J-bolt for the front stabilizer bar instead of the U-bolt. On those units you can line up the coined spot stamped in the middle of the bolt with the slot in the bracket and slide it off. See Figure 10.8.



Figure 10.8

11. DECK LIFT SHAFT ASSEMBLY

- 11.1. If the deck lift shaft itself requires removal, first remove the cutting deck.
- 11.2. Remove the fenders as described in the FENDER REMOVAL section of this manual.
- 11.3. Disconnect the deck lift assist spring that extends from the deck lift shaft to the transaxle torque bracket using a length of starter rope or a spring tool. See Figure 11.3.



Figure 11.3

- 11.4. On models built in 2004 and prior, the lift assist springs extend rearward to a pair of openings with mounting tabs in the back surface of the upper frame. See Figure 11.4.



Figure 11.4

- 11.5. Unbolt the seat bracket mounting plate from the frame (4 screws) using a 1/2" wrench. This will allow the fuel tank to be lifted slightly for clearance, but the tank need not be removed.

- 11.6. With the deck height control lever all the way forward, remove the hairpin clips that secure the deck lift cables to the arms on the deck lift shaft. See Figure 11.6.

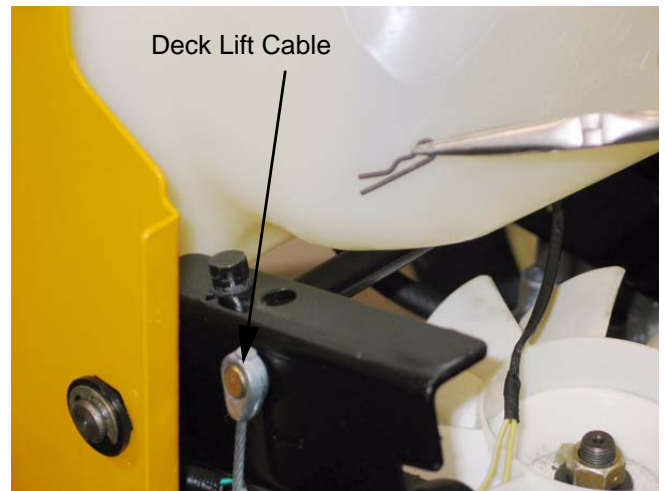

Figure 11.6

- 11.7. Remove the E-clip from each end of the lift-shaft. See Figure 11.7.

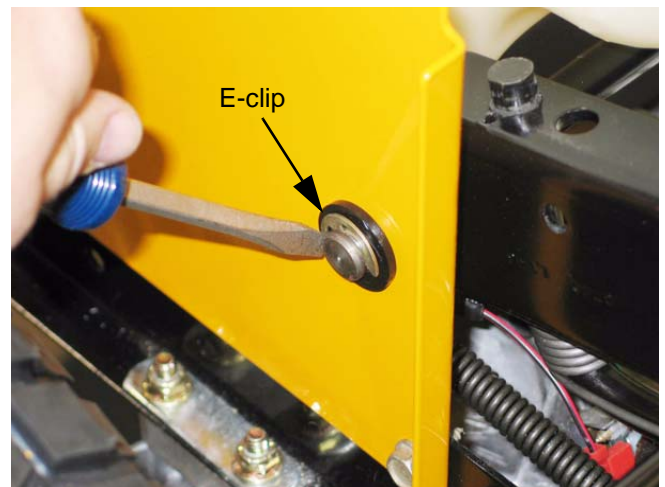

Figure 11.7

- 11.8. Pry the bushings that support the lift shaft out of the frame.

Series 1000 and 1500

- 11.9. Slide the lift shaft assembly to the right, providing clearance to remove the left end of the shaft from the frame. See Figure 11.9.



Figure 11.9

- 11.10. Slide the lift shaft back to the left to remove it from the tractor.
- 11.11. On the bench, relieve torsion spring pressure between the lift shaft and the lever that controls it using a length of starter rope. See Figure 11.11.

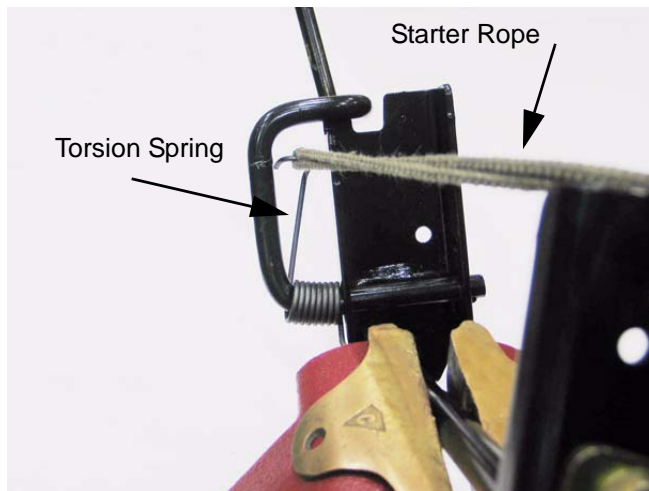

Figure 11.11

- 11.12. Rotate the lever to align the coined “ears” with the slots in the lift shaft arm, allowing separation of the lever from the arm.
- 11.13. Assembly notes:
- Because of the dusty environment that many mowers operate in, grease applied to this bushing may accelerate wear rather than prevent it. If any lubricant is used between the shaft and the

bushing, it should be a dry graphite or PTFE based lube.

- Replace the bushings and E-clips if they show signs of wear.
- Reverse the removal process to install the lift shaft.
- Connect the cables and install the bushings prior to connecting the tension spring between the lift shaft arm and the transaxle torque bracket.

12. LIFT SHAFT BUSHINGS

- 12.1. The most common item on the lift shaft assembly to require service is likely to be the bushings that support the shaft. These bushings are visible beneath the fender. See Figure 12.1.

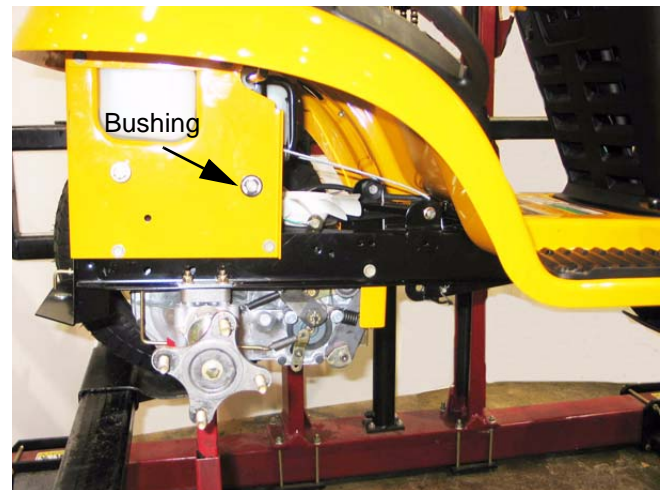

Figure 12.1

- 12.2. When performing normal maintenance that requires deck removal, inspect the lift shaft bushings while the weight of the deck is removed from them.
- These bushings are normal wear items.
 - Grasp the lift shaft and apply up and down force.
 - Watch for shaft motion within the bushings.
 - Larger decks, such as the 50” and 54” (P and K) decks will place a greater load on the bushings.
 - Worn bushings may cause deck leveling issues.
- 12.3. To replace the bushings, the weight of the deck should be removed from the deck lift cable. Remove the cutting deck before attempting to remove the bushings.

- 12.4. Disconnect the deck lift assist spring that extends from the deck lift shaft to the transaxle torque bracket using a length of starter rope or a spring tool. See Figure 12.4.

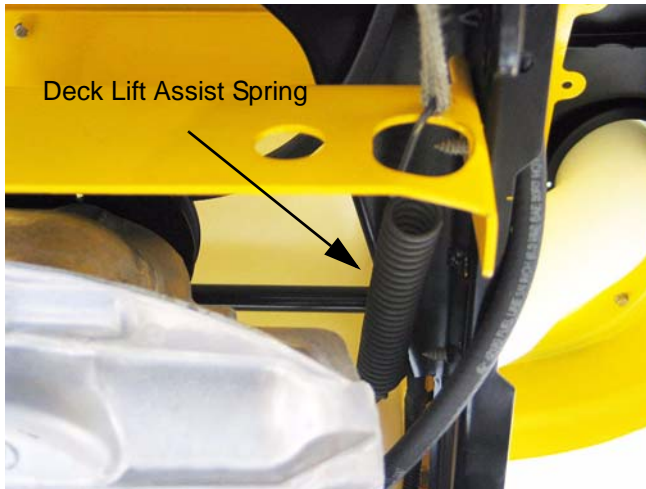

Figure 12.4

- 12.5. Remove the E-clip that holds each shouldered hex bushing into the tractor frame. Replace one bushing at a time.
- 12.6. Pry the worn bushing out of the hole.
- 12.7. Clean any dirt or corrosion from the surface of the lift shaft that contacts the bushing.

NOTE: Because of the dusty environment that many mowers operate in, grease applied to this bushing may accelerate wear rather than prevent it. If any lubricant is used between the shaft and the bushing, it should be a dry graphite or PTFE based lube.

- 12.8. Insert the new bushings, and secure them with the E-clips.
- 12.9. Check deck levelness, and make any necessary adjustments before returning the tractor to service.

13. DECK LIFT CABLES AND PULLEYS

NOTE: The deck lift cables and pulleys can be replaced without removing the rear fenders.

- 13.1. To remove the deck lift cables, remove the cutting deck.
- 13.2. Lift and safely support the rear of the tractor.

- 13.3. Remove the rear tires using a 3/4" wrench. See Figure 13.3.



Figure 13.3

- 13.4. Remove the handle from the rear fenders using a 3/8" wrench. The screws are accessible from inside the rear fender. See Figure 13.4.

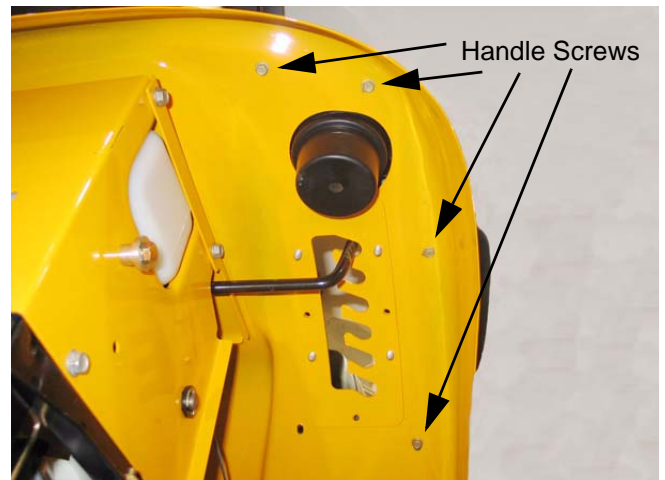

Figure 13.4

Series 1000 and 1500

- 13.5. Remove the notched plate that the deck height control lever seats against in the fender, using a 1/2" socket. See Figure 13.5.



Figure 13.5

- 13.6. Push the deck height control lever as far forward as it will go, and secure the lever in that position.
- 13.7. Remove the pulley that carries the deck lift cable using a 1/2" wrench and a 5/8" wrench.
- 13.8. Remove the E-clip from the same end of the lift shaft that the cable is being removed from. This will allow the lift shaft to be pushed-in slightly, providing clearance for the pin.
- 13.9. Remove the hairpin clip that secures the pin on the top end of the cable to the arm on the deck lift shaft. See Figure 13.9.

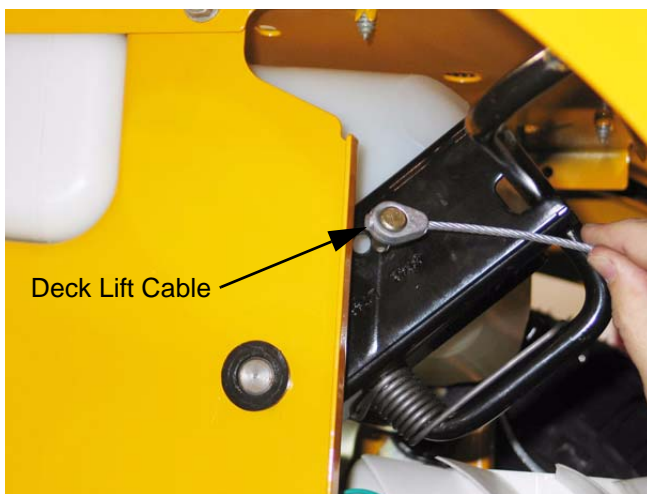

Figure 13.9

NOTE: Early models used a removable clevis pin. Current production cables have captive pins.

- 13.10. Remove the hairpin clip that secures the pin to the lift arm, and remove the cable.

13.11. Installation notes:

- Reverse the removal process to install the cables and pulleys.
- Because of the dusty environment that many mowers operate in, grease applied to the cable or pulley may accelerate wear rather than prevent it. If any lubricant is used on the pulley, it should be a dry graphite or PTFE based lube.
- Replace the pulleys and cables if they show signs of wear.
- Check deck level before returning the tractor to service.
- Tighten fasteners to the following torques:

Lug nuts	75ft-lbs (Nm)
Screws, handle to fender	60 in-lbs (Nm)
Screws, plate to fender	144 in-lbs (Nm)
Shoulder bolts, pulley	144 in-lbs (Nm)

14. LEVELING THE CUTTING DECK

NOTE: Prior to leveling the mowing deck, perform the following steps:

- Check the tire pressure. The front tires will be approximately 14 PSI, and the rear tires will be approximately 10 PSI.
- Place the tractor on a level surface.
- Depress and lock the parking brake.
- Place the cutting deck in cutting position 3 or 4.

SIDE TO SIDE ADJUSTMENT

IMPORTANT: The cutting deck must be even side to side.

- 14.1. Using a work glove or rag, rotate the blades until they are cutting edge tip to cutting edge tip (perpendicular) to the tractor. See Figure 14.1.



Figure 14.1

- 14.2. Measure the outer blade tips to ground. Both measurements taken should be equal.
- NOTE:** If an adjustment is needed, perform the following steps:
- 14.3. Loosen (DO NOT REMOVE) the hex cap screw on the left deck hanger bracket using a 1/2" and a 3/4" wrench. See Figure 14.3.

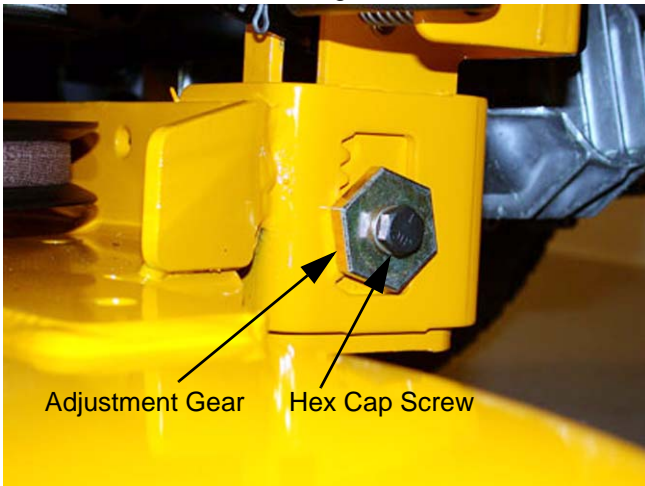

Figure 14.3

- 14.4. Rotate the 3/4" deck adjustment gear right or left until the deck is level side to side and both blade tips to ground are equal in measurement.
- 14.5. Retighten the hex cap screw on the left deck hanger using a 1/2" and a 3/4" wrench when the proper adjustment has been achieved.

FRONT TO REAR ADJUSTMENT

IMPORTANT: The front of the deck will be between 1/4" and 3/8" lower in the front than the rear of the deck.

- 14.6. Using a work glove or a rag, rotate the blades until they are parallel with the tractor frame. See Figure 14.6.

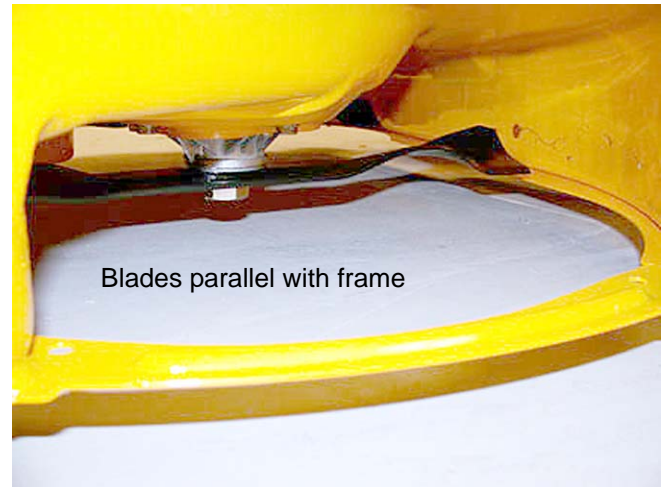

Figure 14.6

- 14.7. Measure the front blade tips to the ground.
- 14.8. Measure the rear blade tips to the ground.
- 14.9. Make certain the front blade tips are 1/4" to 3/8" lower than the rear blade tips.
- NOTE:** If an adjustment is needed, perform the following steps:
- 14.10. There are two types of stabilizer rods. A U-bolt type and a J-bolt type. See Figure 14.10.

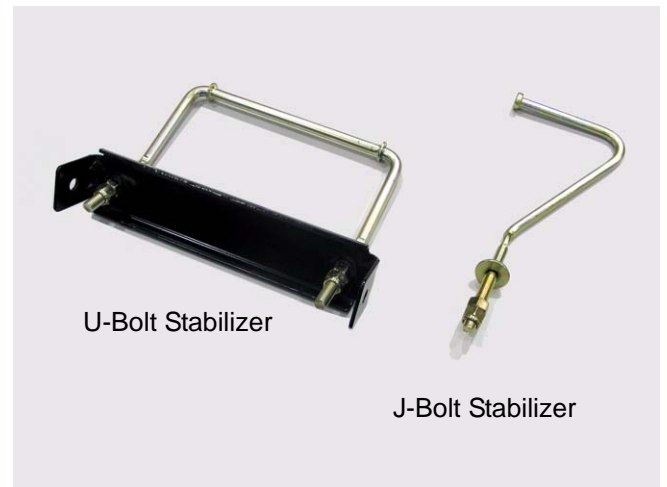

Figure 14.10

Series 1000 and 1500

- **For the U-bolt style:**

14.11. Loosen both lock nuts securing the adjustment nuts on the front of the deck stabilizer bracket using a two 3/4" wrenches.

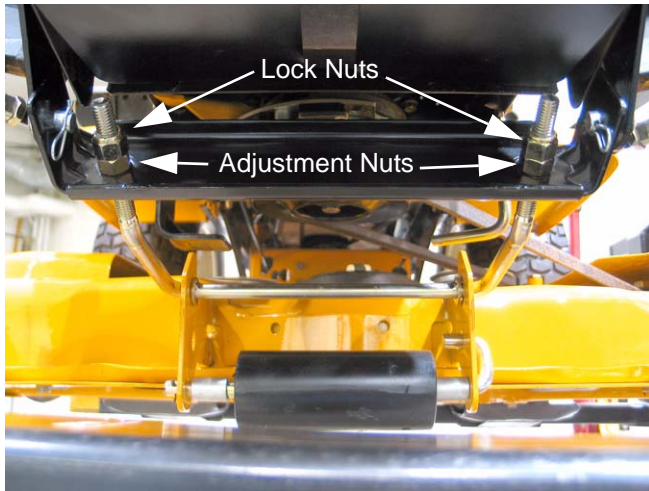

Figure 14.11

14.12. Locate both adjustment nuts on the front side of the deck stabilizer bracket. See Figure 14.11.

14.13. Tighten both nuts to raise the front of the deck or loosen both nuts to lower the front of the deck using a 3/4" wrench.

NOTE: Make sure you count the number of turns you put on the first nut and put the same number on the second nut. both nuts must be moved equally.

14.14. Retighten both lock nuts to jam the adjustment nuts into position when the proper adjustment has been achieved.

- **For the J-bolt Style:**

14.15. The J-bolt style stabilizer is adjusted in a similar fashion. Loosen the single lock nut away from the adjustment nut using two 3/4" wrenches.

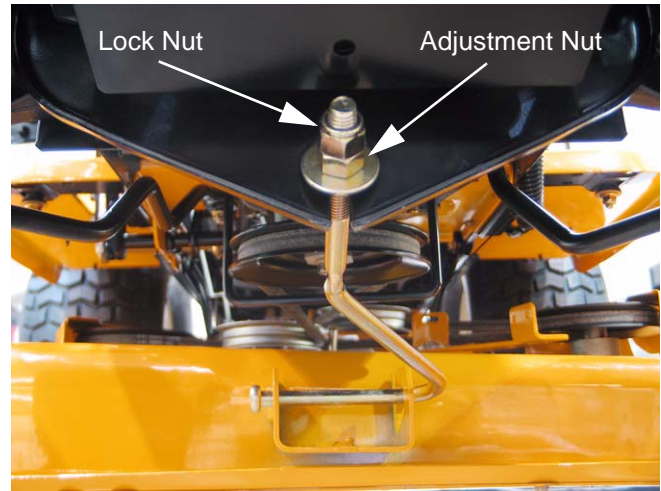

Figure 14.15

14.16. To lower the front of the deck loosen the adjustment nut on the J-bolt. To raise the front of the deck tighten the lock nut. Tighten the lock nut against the adjustment nut when finished.

15. DASH PANEL REMOVAL

15.1. Remove fender, as described in the FENDER REMOVAL section of this manual.

15.2. For the 1500 remove the hood and battery, as described in the HOOD REMOVAL section of this manual.

- For the 1000 remove the fuel tank by first removing the fuel cap. place a piece of plastic over fuel tank opening and put fuel cap back on.

- Remove the four 1/2" screws holding the fuel tank in place.

- Lift the fuel tank and place on top of engine or clamp the fuel line and remove it from the fuel pump and remove fuel tank from unit.

15.3. Pry the cap off the center of the steering wheel.

- 15.4. Remove the steering wheel from the steering shaft using a 1/2" wrench. See Figure 15.4.



Figure 15.4

- 15.5. Disconnect the following dash-mounted electrical devices by unplugging the molded connectors: See Figure 15.5.

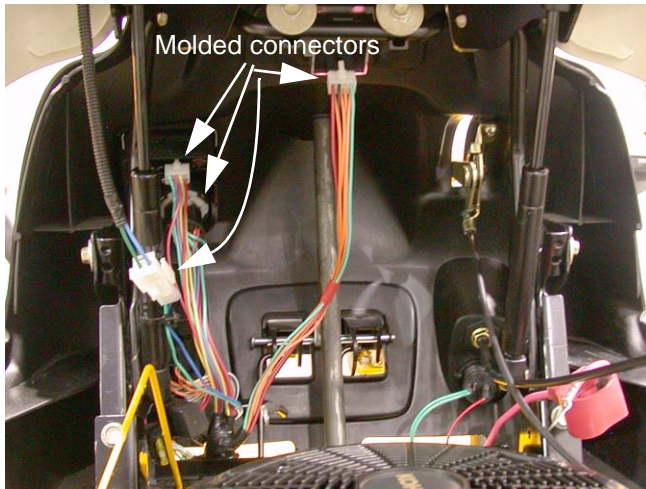

Figure 15.5

NOTE: Image shows 1500 dash. 1000 series dash components are in a similar location.

- Key switch and OCR module
- PTO Switch
- Hour meter / Monitor
- Accessory power port - if present.

- 15.6. Disconnect the rods that connect the Park Brake and Cruise Control mechanisms to the levers on the dash that control those features by removing the hairpin clips. See Figure 15.6.



Figure 15.6

- 15.7. Remove the knob from the throttle lever using a phillips head screwdriver, then remove the screws that hold the throttle assembly to the dash panel. See Figure 15.7.



Figure 15.7

- 15.8. On models with a separate choke cable, disconnect the choke cable at the engine end. If the technician prefers, they may also choose to disconnect the throttle cable at the engine end.
- 15.9. Remove the remaining screws that hold the dash panel to the tractor, and remove the dash.
- Two socket-head cap screws (T-40) at each side of the base of the dash panel (four total).

Series 1000 and 1500

- Two hex-head cap screws holding the rear flange of the dash to the frame (1/2" wrench)
- Two hex-head cap screws holding the top of the dash to the dash support (3/8" wrench). See Figure 15.9.

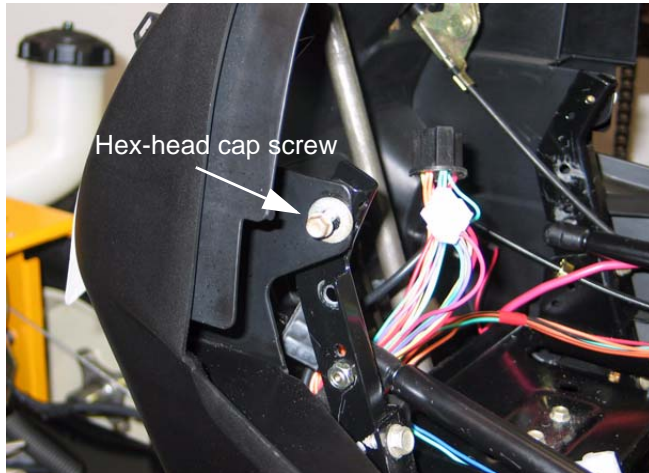

Figure 15.9

- 15.10. Reverse the removal process to install the dash panel.
- Test the operation of all safety features in a safe area that is clear of obstacles and bystanders before returning the tractor to service.
 - Test the operation of all controls in a safe area that is clear of obstacles and bystanders before returning the tractor to service.

16. CRUISE CONTROL AND PARK BRAKE LINKAGES

- 16.1. Open the hood.
- 16.2. On the 1000 series you need to remove the fuel tank. on the 1500 series you need to remove the battery.
- 16.3. The procedure for removing the park brake linkage and the cruise control linkage is the same. you can remove both at the same time.

- 16.4. Remove the hair pin clips holding the linkages to the levers in the dash. See Figure 16.4.

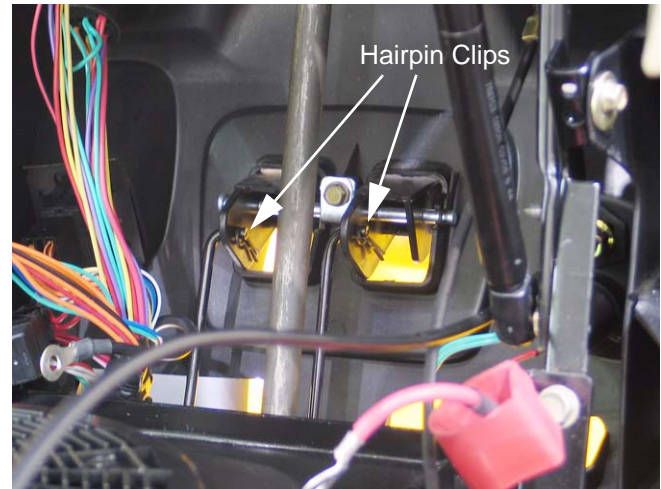

Figure 16.4

- 16.5. Remove the screw holding the pivot rod in place. See Figure 16.5.

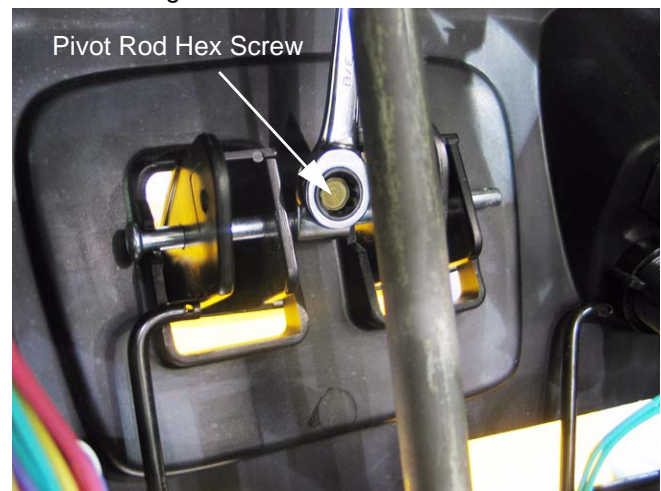

Figure 16.5

- 16.6. Remove the hair pin clip in the pivot rod.
- 16.7. Work the pivot rod out. sliding it out to the right. the levers will fall out as the rod clears them.
- 16.8. Raise the unit off of the ground.
- 16.9. Remove the brake and drive pedals.

16.10. Remove the cotter pins in the brake pedal shaft and the drive pedal shafts. See Figure 16.10..

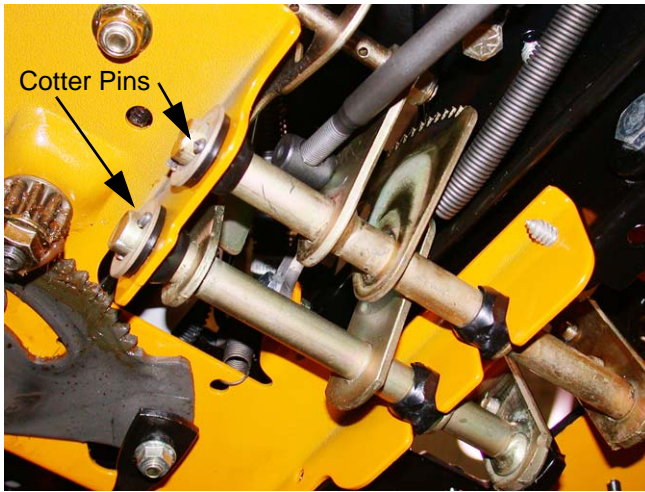

Figure 16.10

16.11. Slide the drive pedal to the right. The inboard bushing and washer can now be removed. Continue working the drive pedal shaft to the right and slip it out of the unit.

16.12. Remove the hair pin clip in the brake rod and disconnect it from the brake pedal shaft.

16.13. Remove the return spring from the brake pedal shaft.

16.14. Slide the brake pedal shaft to the right and remove the inboard bushing and washer. Continue sliding the brake pedal shaft to the right and work it off of the unit.

16.15. Remove both drag links from the tractor.

NOTE: Make sure to keep the drag links separate so the you know which one is for the left and which one is for the right. they are not marked and they are not interchangeable.

16.16. Remove the lock nut from the bottom of the steering shaft. Then slide off the steering shaft gear. See Figure 16.16.

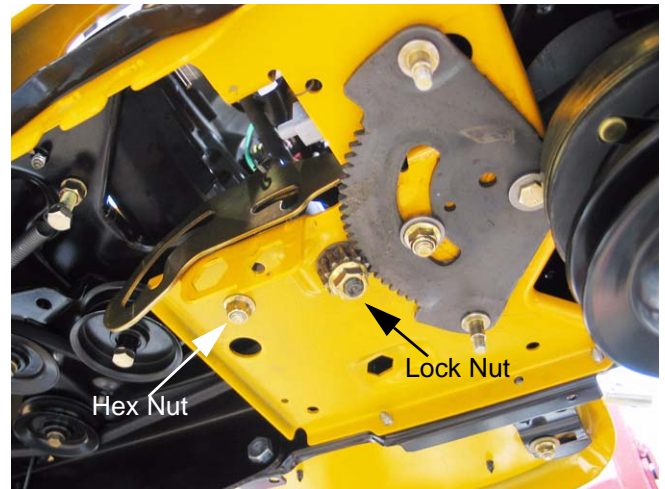

Figure 16.16

16.17. Reaching up through the opening where the pedal shafts were, place a 9/16" wrench on the head of the bolt located in the center rear of the subframe. Using a 9/16" socket, remove the nut. See Figure 16.16.

NOTE: There is a sleeve on this bolt that acts as a spacer between the sub-frame and frame. Be aware of this sleeve when you lower the sub-frame in a later step.

16.18. There are four screws holding the subframe to the tractor. Two on each side. Loosen the two front screws and remove the two rear screws. See Figure 16.18.

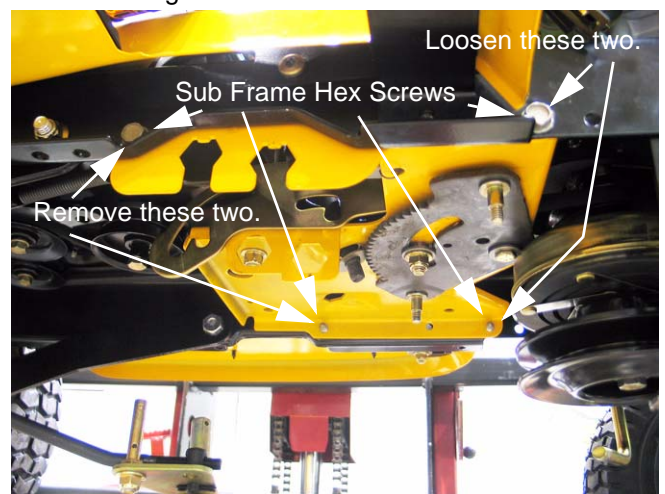

Figure 16.18

Series 1000 and 1500

16.19. Pivot the subframe down. Be careful of the spacer on the bolt and the hex flange bushing for the steering shaft, they will fall out.

16.20. You now have access to the cruise linkage and cam lock. You also have access the park brake linkage and locking plate. See Figure 16.20.

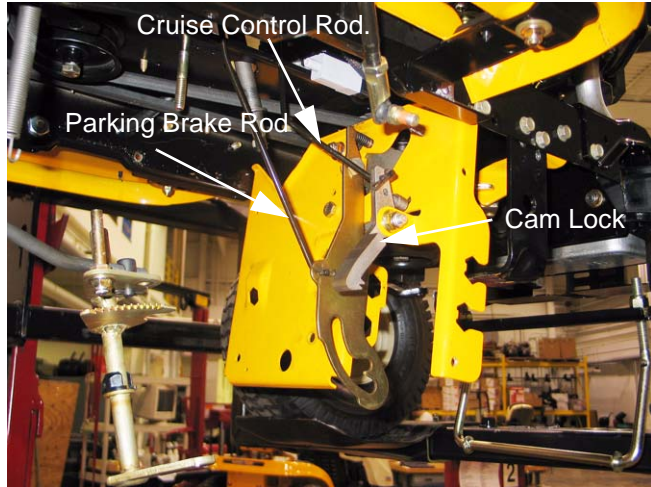

Figure 16.20

16.21. Remove the hair pin clips on the linkages. Remove the linkages.

16.22. Remove the nut and bolt holding the cruise cam and/or the park brake locking plate.

16.23. Reassemble in reverse order.

CAUTION: Make sure the linkage rods are routed properly before you swing the subframe

17. TRACTION DRIVE BELT REPLACEMENT: CVT

NOTE: There are two drive belts in the CVT system. Because they work together on the variable speed pulley, wear to one belt effects the performance of the other belt. It is strongly recommended that the belts be replaced as a set.

17.1. Remove the cutting deck from the tractor.

17.2. Tilt-up the seat and disconnect the battery cables (ground cable first) using a 7/16" wrench.

17.3. Remove the battery hold-down, remove the battery and the battery tray. See Figure 17.3.

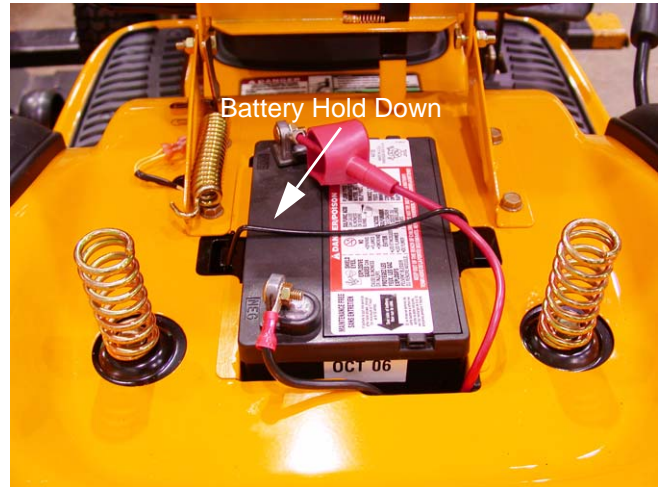

Figure 17.3

17.4. Pull the upper drive belt tensioner pulley rearwards to provide slack in the belt, and roll the belt off of the tensioner pulley. See Figure 17.4.

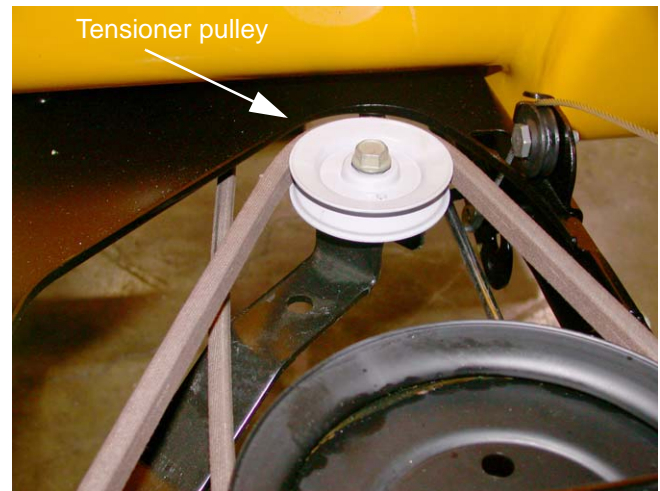

Figure 17.4

17.5. Carefully release the tensioner pulley.

17.6. Using the slack created by taking the belt off the tensioner pulley, slip the belt off of the transaxle input pulley and the upper sheave of the variable speed pulley and remove the belt from the tractor. You may need to remove the transmission input pulley to get enough clearance to remove the belt. See Figure 17.6.

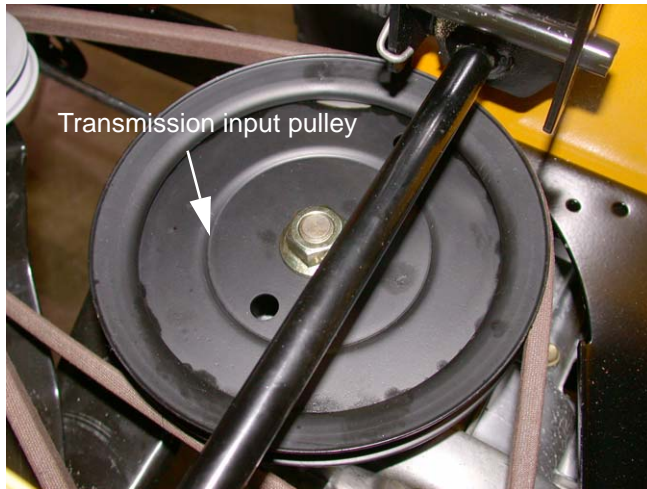

Figure 17.6

17.7. Loosen but do not remove the bracket that supports the variable speed pulley using a 1/2" wrench. See Figure 17.7.

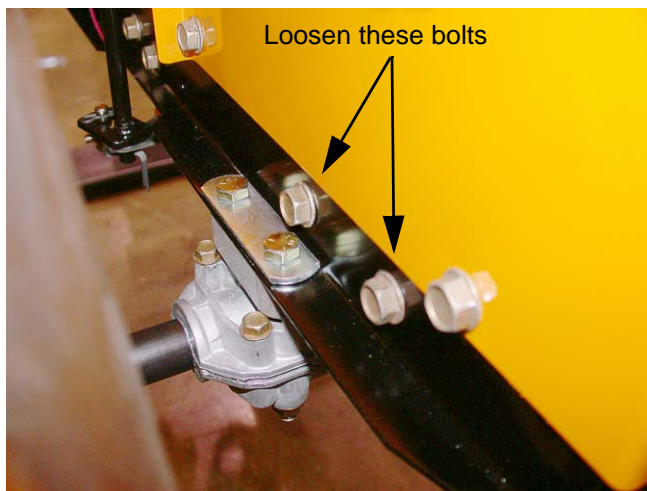
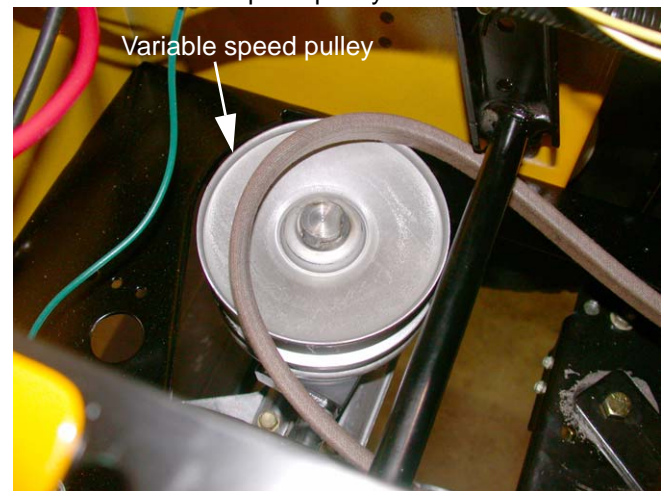

Figure 17.7

NOTE: On 2004 and earlier CVT models, the variable speed pulley was mounted directly to the transaxle housing. On those tractors, remove the variable speed pulley from the tractor using a pair of 9/16" wrenches.

17.8. Lift the sliding center partition of the variable speed pulley as far as it will go. This should provide enough clearance to slip the lower belt off of the variable speed pulley.



17.9. Locate the double idler pulley bracket beneath the tractor. See Figure 17.9.

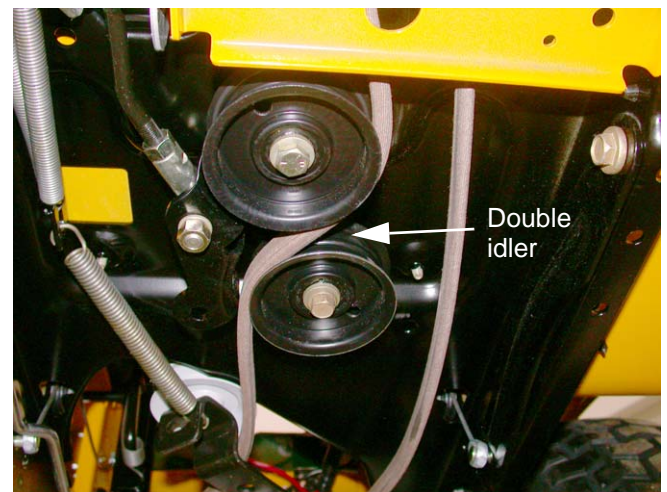

Figure 17.9

NOTE: This is the pair of pulleys that moves in reaction to drive pedal input from the operator. The further the pedal is depressed, the further the bracket pivots, applying more tension to the belt.

17.10. Slip the lower drive belt off of the pulleys.

NOTE: On some 2004 and earlier models, it may be necessary to loosen but not remove the rear-most of the two pulleys (riding against the flat side of the belt) to provide clearance to remove the belt.

Series 1000 and 1500

17.11. Disconnect the plug for the PTO clutch wire. It is located on the right side of the tractor, just above the opening in the frame that the wire passes through to reach the PTO clutch. See Figure 17.11.

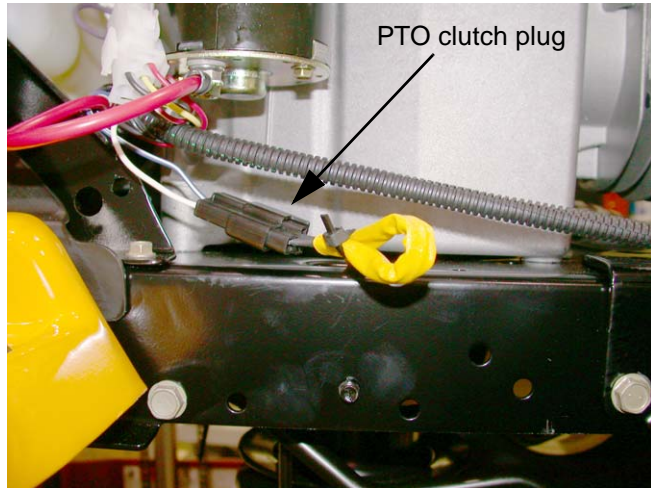

Figure 17.11

17.12. Remove the bolt that holds the PTO clutch to the crankshaft using a 5/8" wrench. See Figure 17.12.

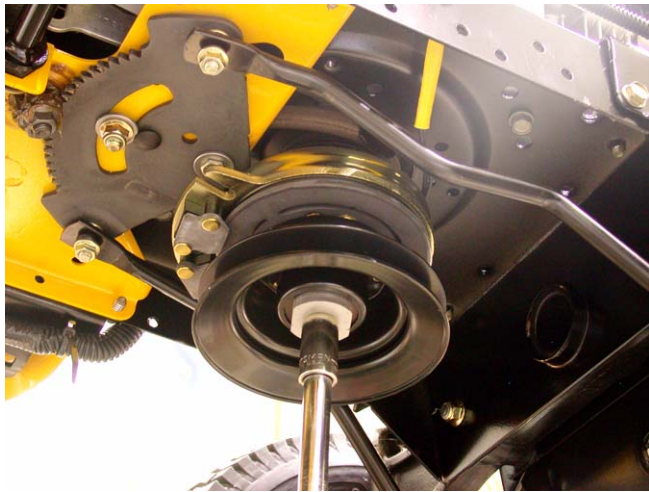

Figure 17.12

NOTE: If an impact wrench is unavailable it may be necessary to use an improvised piston stop or to hold the flywheel.

NOTE: On some models you may have to remove the belt guide on the engine. Remove the 1/2" bolt securing the belt guide to the frame on the left hand side and slide the guide out of the hole on the right hand side. See Figure 17.12.

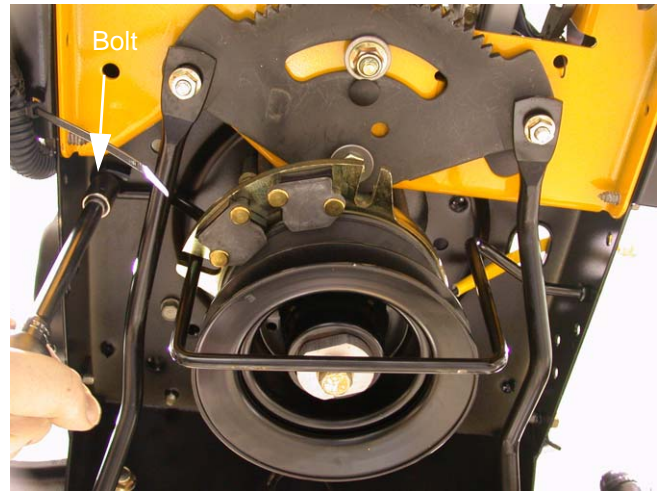

Figure 17.12

17.13. Carefully lower the PTO clutch and any associated hardware off of the crankshaft.

17.14. Lower the drive pulley far enough to allow the belt to slip past the keepers that are stamped into the frame. Slip the belt off of the pulley and remove the pulley. See Figure 17.14.

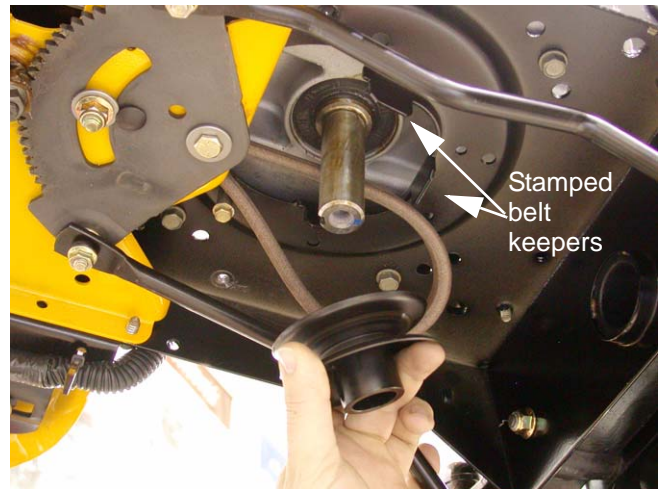

Figure 17.14

NOTE: Keep track of the position of any spacers or washers that accompany the PTO clutch and crankshaft pulley. Several different configurations have been used.

17.15. Remove the belt from the tractor.

NOTE: There were a small number of tractors made using a CVT drive and a 2-speed (L-H-N-R) GT transaxle. The belt must pass over the center mounted gear selector on these models for removal. Remove the knob from the gear selector, and remove the shift gait from the fender assembly to provide clearance.

17.16. Assembly notes:

- Install the belts by reversing the order of the removal process.
- The engine drive pulley is installed on the drive shaft with the key side facing down.
- Line up the key on the PTO clutch during assembly.
- There is a large flat washer that goes on top of the PTO clutch during assembly.
- Torque the PTO clutch bolt during assembly.
- When installing the belt guide, make sure that it passes through the cutout in the PTO clutch. this acts as a anti-rotation bracket. See Figure 17.16.

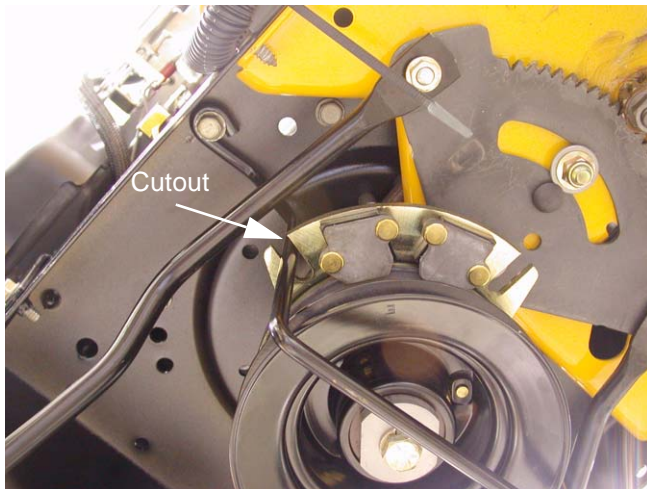

Figure 17.16

18. DRIVE SYSTEM ADJUSTMENT: CVT

18.1. Make an **operational test** of the tractor:

- The tractor should not “creep” when the transmission is in gear and the drive pedal is not depressed.
- On level ground, with the brake released, the gear selector should slip smoothly into gear. It is normal for gear engagement to be more difficult on a grade, or with the brakes applied because it is more difficult for the drive dogs to engage under load or bind.

- The tractor’s forward ground speed should vary smoothly between 0 and 5.2 MPH when the drive pedal is depressed progressively to the end of it’s travel.
- It is normal for the cruise control to hold a mowing speed that is about 10% less than the 5.2 MPH transport speed.
- If the tractor performs as described, no adjustment is required.

18.2. **Diagnosis:** If the tractor does not move at all, and the engine does not seem to be laboring as the pedal is depressed, the issue may be in the CVT belt system, the shift linkage leading to the transaxle, or within the transaxle itself.

18.3. To isolate the CVT belt system:

- Turn-off the engine.
- Release the parking brake.
- Place the gear selector in any motion gear.
- Attempt to push the tractor.
- If the tractor rolls, examine the shift linkage.
- If the wheels lock when a gear is engaged, the transaxle and shift linkage are not likely to be the problem.

18.4. If the tractor does not move at all, and the engine seems to be laboring as the pedal is depressed, the issue may be in the brake, or within the transaxle itself:

- Turn-off the engine.
- Release the parking brake.
- Place the gear selector in Neutral.
- Attempt to push the tractor.
- If the tractor rolls with difficulty, examine the brakes as described in the “BRAKE ADJUSTMENT: CVT” section of this manual.

18.5. If the problem can be isolated to CVT belt drive system, make a visual inspection of the CVT belt drive system:

- Turn the engine off, and allow it to cool before starting to work on the tractor.
- Remove the cutting deck.
- Lift the seat.
- Disconnect the battery cables, negative cable first, using a 7/16” wrench
- Remove the battery hold-down.

Series 1000 and 1500

- Remove the battery and battery tray from the tractor.

18.6. Inspect the upper drive belt: See Figure 18.6.

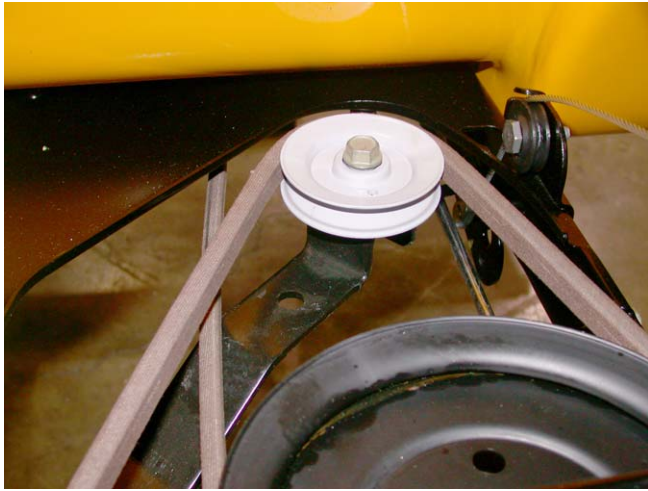

Figure 18.6

- Is the upper drive belt correctly positioned on the tensioner pulley, transaxle input shaft pulley, and the upper sheave of the variable speed pulley?
 - Inspect the type and condition of the belt.
 - Check the bearing on the tensioner pulley.
 - Check the tensioner pulley arm: it should return readily to static position under spring tension.
 - The center partition of the variable speed pulley should move up with light force and down under its own weight.
- 18.7. The pulley on the transaxle input shaft should be firmly attached.
- Early production tractors used a splined joint between the pulley and the input shaft.
 - Current production tractors carry the pulley on a separate hub that fits over the splined shaft.

NOTE: The nut securing the pulley should be tightened to a torque of 10-15 ft.-lbs using an 11/16" wrench. Over-torquing the nut may shear the input shaft. Replace the Belleville washer between the nut and the pulley if it is flattened.

NOTE: Some models used a special "fully finished" nut with an extended washer face. Do not replace this nut with a standard nut unless a washer is added between the nut and the pulley. The washer must have a big enough O.D. to fit over the star shape on the pulley adaptor, and must be sufficiently thick to transfer compression

loads (from torquing the nut) directly to the pulley, not the adaptor.

18.8. Repair any problems found. If the upper drive belt is correct and in serviceable condition, reinstall it. If the upper drive belt needs to be replaced, the lower drive belt should be replaced as well. Refer to the "TRACTION DRIVE BELT REPLACEMENT" section of this manual.

18.9. Operate the drive pedal while observing the movement of the components controlled by the drive pedal. See Figure 18.9.

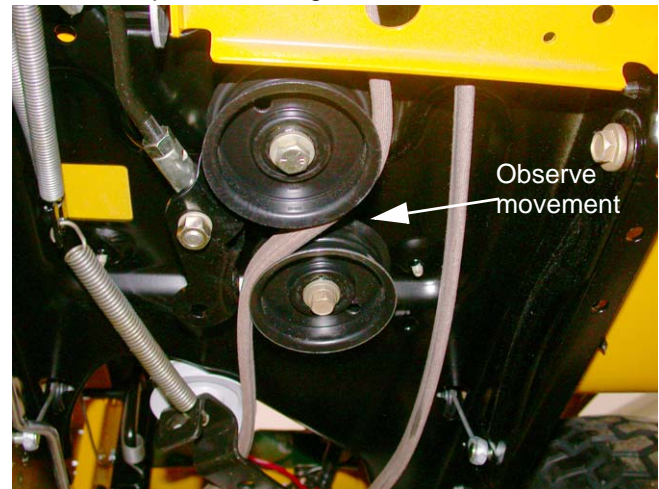

Figure 18.9

18.10. The double idler bracket should move with about 10 lbs pressure applied to the pedal, and return under spring pressure as the pedal is released. See Figure 18.10.

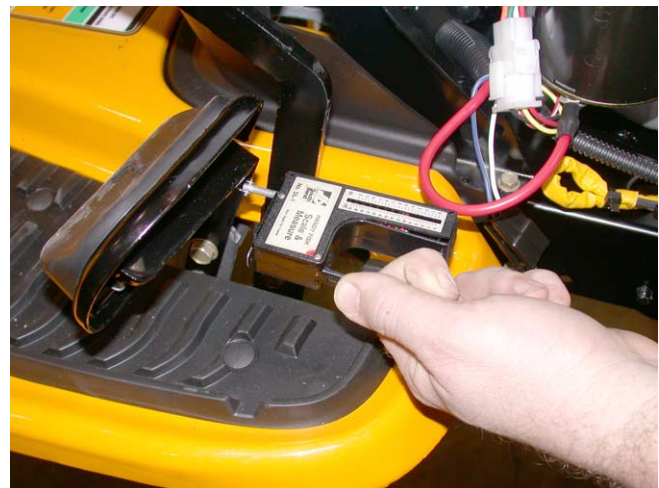

Figure 18.10

18.11. The empty hole in the double idler bracket should swing through an arc of $1\frac{3}{8}$ " when 10 lbs. of force is applied to the drive pedal. See Figure 18.11.

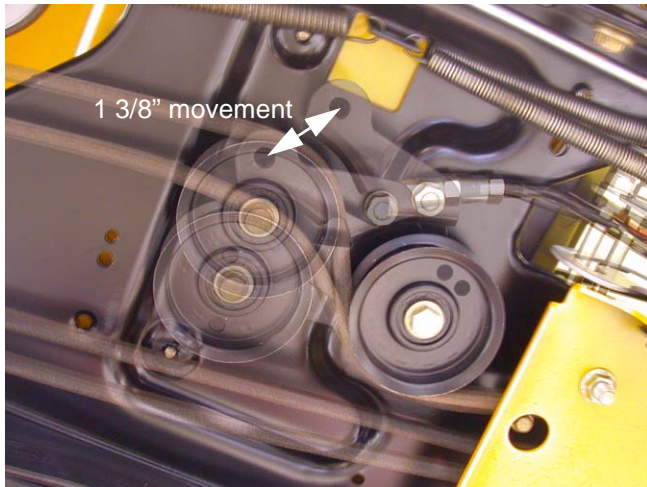

Figure 18.11

18.12. If the measurement is not $1\frac{3}{8}$ ", check the type and condition of the lower drive belt. If the lower drive belt is worn or incorrect, replace both drive belts before adjusting the speed control. Refer to the "TRACTION DRIVE BELT REPLACEMENT: CVT" section of this manual.

18.13. If the belts are serviceable and correct, adjust the length of the speed control rod to achieve the correct double idler bracket travel as described in the following steps:

18.14. Loosen the jam nut that locks the speed control rod into the rod-end joint at the double idler bracket with a pair of $9/16$ " wrenches. See Figure 18.14.

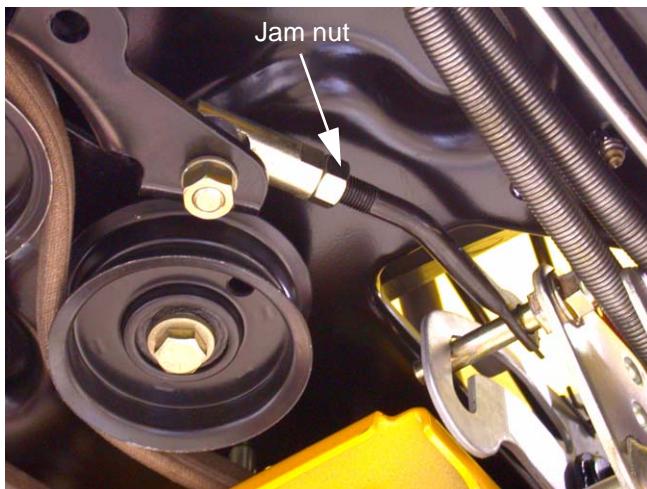

Figure 18.14

18.15. The forward end of the speed control rod connects to a pin attached to the speed control assembly.

NOTE: On 2005 production units you can remove the nut on the ball joint and lift it out of the idler bracket on an angle, then skip to step 15.16. See Figure 18.15.

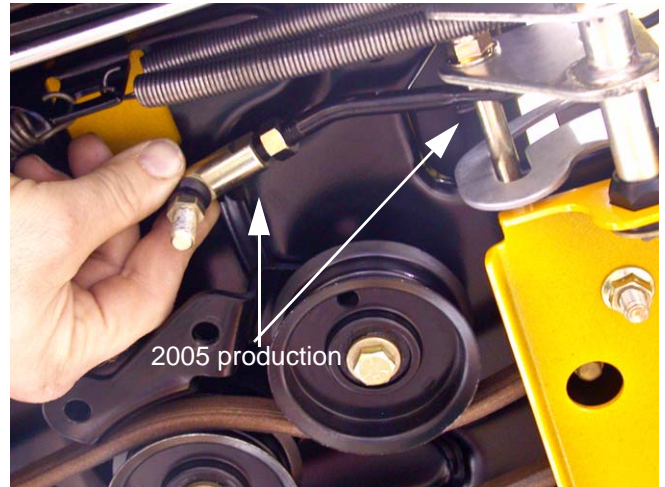

Figure 18.15

- Early production models may have a hairpin clip and washer adjacent to the cam plate that prevents the speed control linkage from moving when the parking brake is applied.
- Remove the hairpin clip and washer if so equipped.
- Disconnect the pin from the speed control assembly using a pair of $9/16$ " wrenches.

18.16. Thread the rod in or out of the rod-end as required to achieve the correct linkage travel.

18.17. When adjustment is complete:

- Secure the linkage and tighten any loosened fasteners.
- Install the battery tray and battery.
- Test the operation of the drive system in a safe area that is free of obstacles, hazards, and bystanders.
- After successful testing, install the cutting deck, test all safety features, and return the mower to service.

Series 1000 and 1500

19. BRAKE ADJUSTMENT: CVT

- 19.1. On CVT-driven lawn and garden tractors, most of the braking force is generated within the transaxle: when the drive pedal is released, the drive ratio changes, slowing the tractor. The brake brings the tractor to a complete stop, and functions as a parking brake.
- 19.2. When properly adjusted, the brake should do two things: it should stop and hold the tractor when applied, and it should not drag when released.
- 19.3. To check that the brakes hold the tractor:
- Place the gear selector in Neutral.
 - Set the parking brake.
 - Attempt to push the tractor.
 - The wheels should skid without rotating.
 - If the brakes do not hold the tractor, the brake needs to be adjusted or repaired.
- 19.4. To check that the brakes do not drag:
- Place the gear selector in Neutral.
 - Release the parking brake.
 - Attempt to push the tractor - it should move with less than 20 lbs. of force. More force indicates drag.
 - If the brakes drag, they need to be adjusted or repaired.
- 19.5. There is no linkage adjustment. All adjustment is done at the brake caliper.
- 19.6. To reach the brake caliper, lift and safely support the right rear corner of the tractor.
- 19.7. Remove the right rear wheel of the tractor using a 3/4" socket.

- 19.8. CVT-driven transaxles use a self locking nut on the brake adjustment. See Figure 19.8.

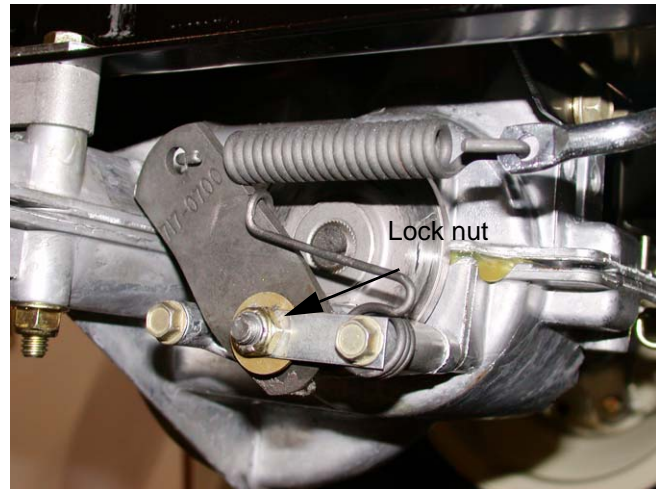

Figure 19.8

- 19.9. Insert a .013" feeler gauge between the brake rotor and the outer brake pad. There should be slight drag on the feeler gauge.
- 19.10. If the feeler gauge is too loose, or will not go in, brake caliper adjustment is necessary.
- 19.11. A 1/2" wrench will turn the adjustment nut. See Figure 19.11.

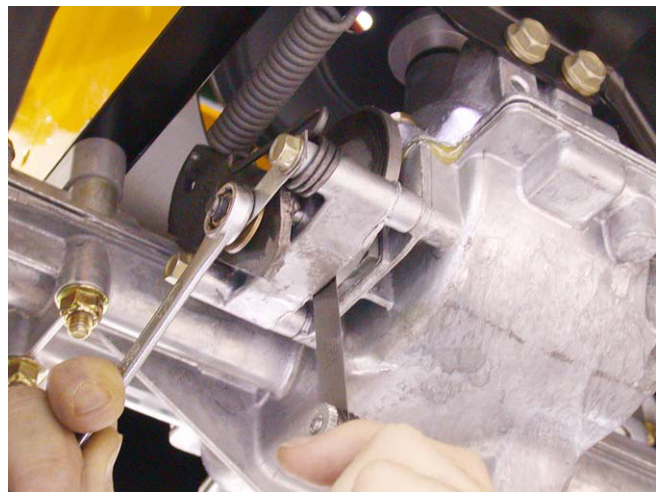

Figure 19.11

- 19.12. Tighten the nut to reduce the clearance. Loosen the nut to increase the clearance.

19.13. Check the movement of the brake arm:

- The brake arm should move forward as the brake is applied.
- The return spring should draw the brake arm back against the spacer when the brakes are released.

19.14. Visually check the thickness of the brake pads: they are visible within the caliper.

19.15. Check the brake rotor:

- Confirm that the brake rotor floats on the splined shaft by sliding it in and out with light finger pressure.
- If it binds on the shaft it may cause brake drag and reduced holding performance.
- A rotor that has been dragging will frequently be discolored by the heat (blue).

19.16. If the brakes are dragging or worn, or if the rotor needs to be removed from the shaft, remove the two bolts that hold the caliper to the transaxle using a 3/8" wrench. See Figure 19.16.

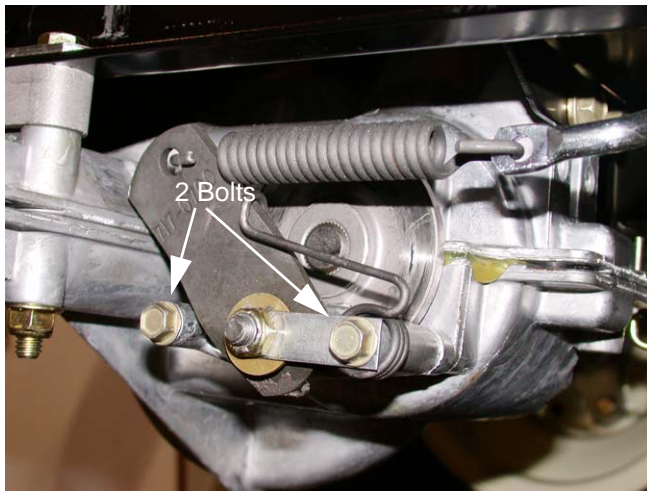

Figure 19.16

19.17. Remove the caliper from the transaxle. The brake actuator arm can now be unhooked from the spring that connects it to the linkage. See Figure 19.17.

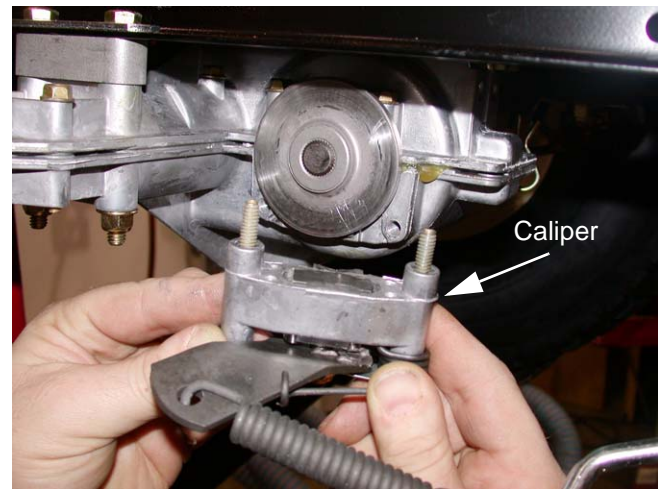

Figure 19.17

19.18. The rotor should slip-off of the splined shaft, providing access to the fixed brake pad. See Figure 19.18.



Figure 19.18

Series 1000 and 1500

19.19. A crease in the brake arm acts as a cam. At rest, the ends of the two pins ride in the peak of the crease: See Figure 19.19.



Figure 19.19

- The brake arm pivots on a square-headed stud.
- The two pins are forced against the backing plate when force is applied to the arm.
- The backing plate rides between the pins and the pad, to prevent the pins from damaging the brake pad.

19.20. Replace the pads if they are worn. They frequently last many years unless the brakes have been dragging.

19.21. Be sure the pin bores are clear of dirt and corrosion: either may cause the pins to bind and the brakes to drag.

19.22. On assembly, apply a small amount of dry graphite lubricant to the pins and the spots on the brake arm that they contact. Do not allow any lubricant to get on the brake pad.

19.23. Install the brake caliper, tightening the two nuts to 7 to 10 ft.-lbs., then check and adjust the pad-to-rotor clearance.

19.24. Install the rear wheel, tightening the lug nuts to a torque of 350 to 500 In.-lbs. Lower the tractor to the ground.

19.25. After any brake service is performed, test the brakes as described in steps 24.2 through 24.4, then test-drive the tractor in a safe area that is free of hazards, obstacles, and by-standers before returning the tractor to service.

20. SERVICING THE BRAKE PEDAL SHAFT BUSHINGS:

- If there is insufficient travel in the linkage to fully apply the brakes, a simple visual inspection should identify the cause.

20.1. Confirm that the brake pedal is firmly attached to the pedal shaft. See Figure 20.1.

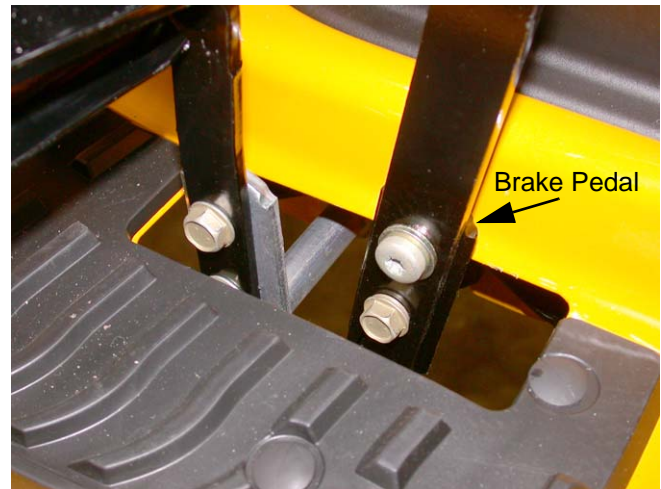

Figure 20.1

20.2. Remove the cutting deck to reach the brake pedal shaft, bushings, and bracket.

20.3. Check for excessive play in the bushings. Replace them if they are worn.

NOTE: It is suggested that if any of these bushings need to be replaced, replace all of the pedal shaft bushings at this time. The speed control pedal shaft bushings are replaced in a similar manner.

20.4. The inboard brake pedal shaft bushing can be removed by removing the cotter pin and washer that secure it. See Figure 20.4.

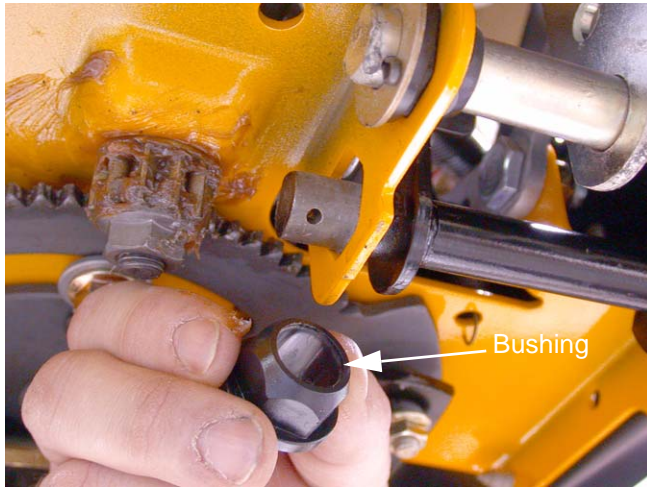

Figure 20.4

20.6. Press the brake pedal shaft as far outward as possible, and pry the worn bushing out of the bracket. See Figure 20.6.

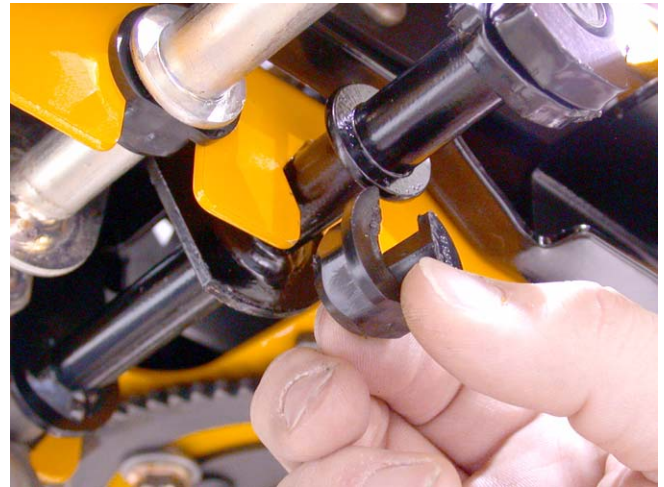

Figure 20.6

20.5. The brake rod must be disconnected to remove the outboard brake pedal shaft bushing. Remove and discard the cotter pin that holds the brake rod to the brake pedal shaft. See Figure 20.5.

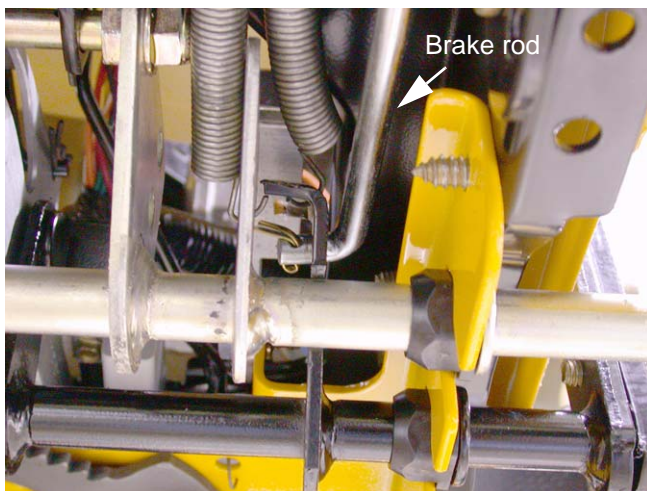

Figure 20.5

NOTE: A pair of vice-grips and a plate can be used to press the end of the shaft flush with the edge of the bracket

NOTE: The inner bushing is a hex flange bushing. The outer bushing is similar, but has one open side. The “tooth” in the top facet of the bracket that supports the bushing registers in open side of the bushing.

20.7. Clean any corrosion or dirt from the surfaces where the pedal shaft contacts the bushing, and slip the new bushings into place. See Figure 20.7.

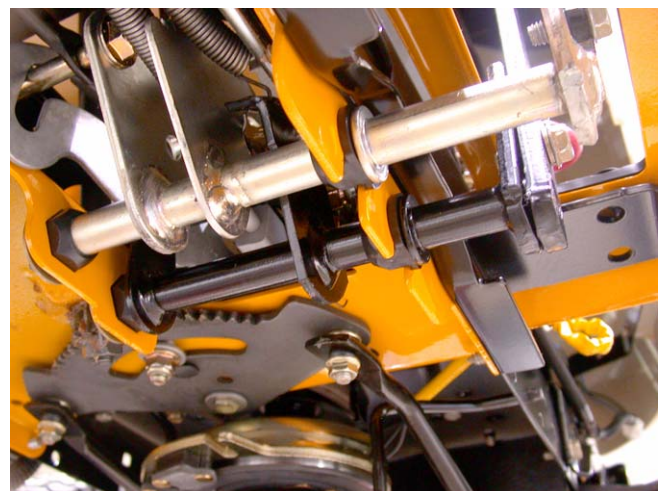

Figure 20.7

Series 1000 and 1500

NOTE: Lubrication with grease may accelerate bushing wear. If lubrication is applied it should be in dry form such as graphite or PTFE (Teflon).

- 20.8. Secure the inner bushing with a new cotter pin and the flat washer that was previously removed.
- 20.9. Move the pedal through it's range of travel to check for binding. If binding is encountered:
 - Bind in just a portion of the travel may be caused by a bent pedal shaft.
 - Constant bind is likely to be caused by a bent bracket.
 - Also check for interference between the parking brake and cruise control interlocks.
- 20.10. Correct any binding condition.
- 20.11. Connect the brake rod to the brake pedal shaft, and secure it with a new cotter pin.
- 20.12. After any brake service is performed, test the brakes as described in steps 14.2 through 14.4, then test-drive the tractor in a safe area that is free of hazards, obstacles, and by-standers before returning the tractor to service.

21. TRANSAXLE REPLACEMENT: CVT

- The single speed transaxles used in our CVT riders has evolved over the years. Internals have changed. Some have had the Variable Speed Pulley integrated into the transaxle. If you are replacing a transaxle it is very important to carefully match the transmission part numbers between the old and new. A part number on the transmission case might be the number of the case half. Visually compare the IPL drawing with the actual transaxle to assure a match.
 - Before condemning a transaxle, check to make sure the brake is not locking up the transaxle.
 - Check the drive belts for damage or wear and make sure they are the correct belts and are not the cause of drive problems.
 - When replacing a transaxle within the warranty period, we have a like-kind exchange program.
 - Out of warranty transaxles can be serviced.
- 21.1. Disconnect the battery cables (negative first and then positive).

- 21.2. Remove the battery hold down, battery and battery tray from the unit. See Figure 21.2.

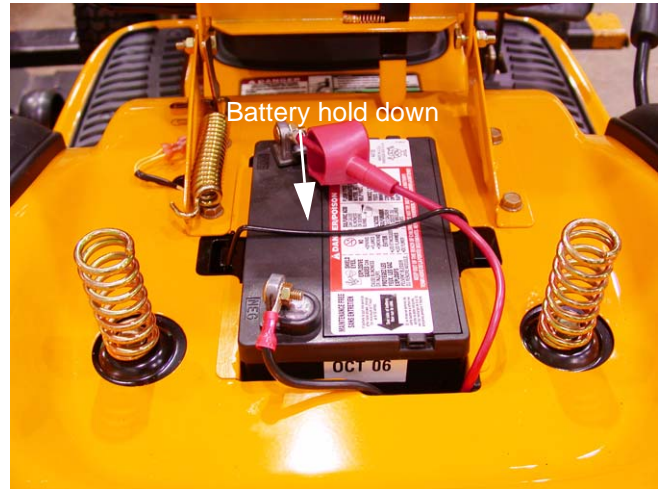

Figure 21.2

- 21.3. Take tension off of the transmission belt idler and remove the belt from around the idler pulley. See Figure 21.3.

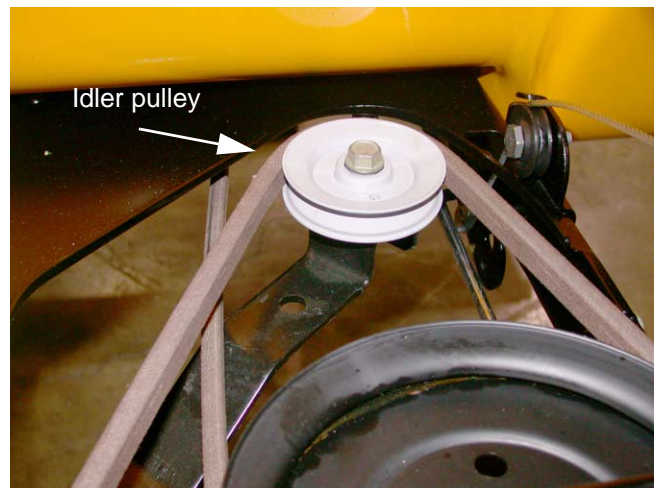

Figure 21.3

21.4. Using a 7/8 socket and extension, remove the nut securing the transmission pulley to the transmission. See Figure 21.4.

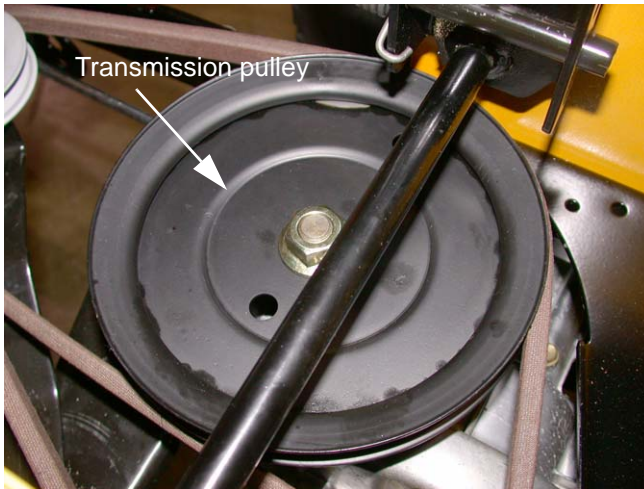

Figure 21.4

21.5. Remove the pulley from the unit.

21.6. Support the frame of the unit to allow removal of both rear wheels. See Figure 21.6.



Figure 21.6

NOTE: Leave room under the rider to allow lowering the transaxle from the unit.

21.7. Disconnect the brake linkage where it connects to the brake spring. See Figure 21.7.

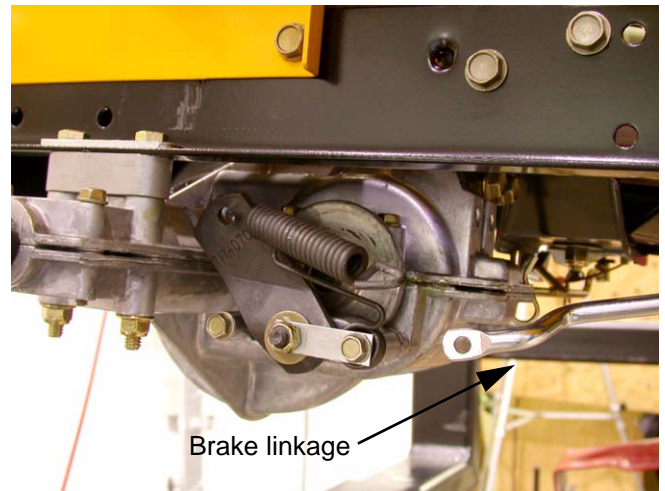

Figure 21.7

21.8. Use white-out to mark the position of the ferrule on the transmission shift rod.

21.9. Remove the hairpin clip securing the transmission shift rod to the transmission. See Figure 21.9.

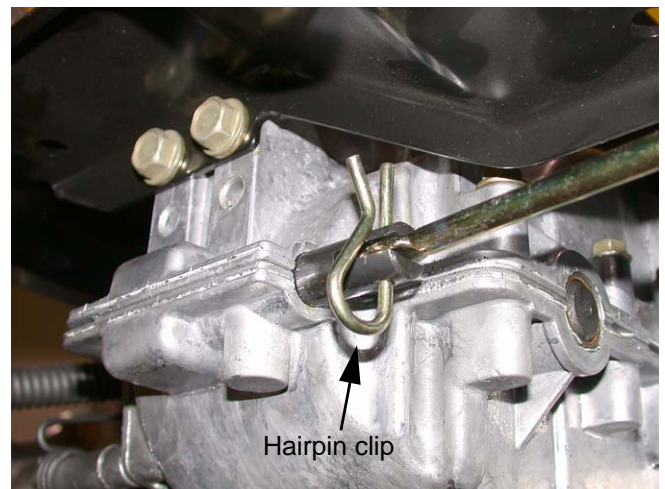

Figure 21.9

21.10. Using a 1/2" socket, remove the two hex screws securing the front of the transmission housing to the transmission support bracket. See Figure 21.9.

21.11. Support the transmission from below.

Series 1000 and 1500

21.12. Using a 1/2" socket and 1/2" wrench, remove the four hex nuts securing the transmission to the frame. See Figure 21.12.

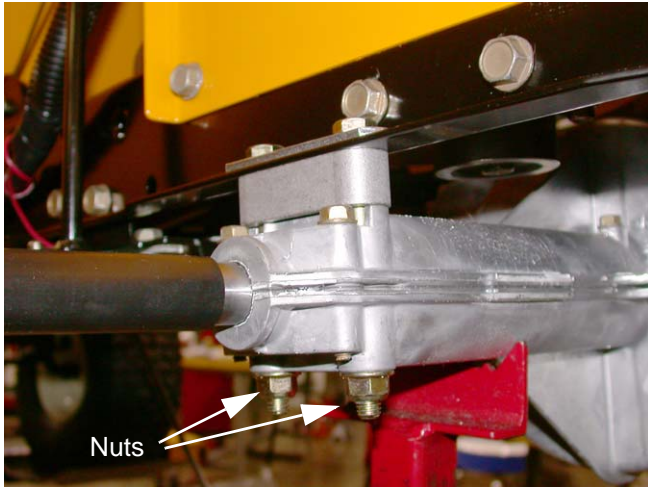

Figure 21.12

CAUTION: The transmission must be supported during removal of the bolts. Use a helper if necessary.

21.13. Lower the transmission from the rider. See Figure 21.13.



Figure 21.13

NOTE: There is a backing plate on the top of the frame. There may be a spacer between the frame and the transmission housing.

21.14. Reassemble in the reverse order of disassembly.

NOTE: If it appears that the drive belts are worn, we recommend replacing both of them when servicing the transaxle. Use original OEM belts to assure proper operation of the rider.

22. TRANSAXLE SERVICE AND INTERNALS: CVT

- Transaxles needing service within the warranty period qualify for like-kind exchange.
- If you are servicing transaxle internals, keep in mind that different transaxles/components have been used over the years.
- Carefully compare the transaxle with the illustrated parts list when ordering components.

23. TRACTION DRIVE BELT REPLACEMENT: HYDROSTATIC LT

23.1. Turn-off the engine and allow all parts to cool before beginning work.

23.2. Remove the cutting deck.

23.3. Identify and unplug the wires leading to the electric PTO clutch. See Figure 23.3.

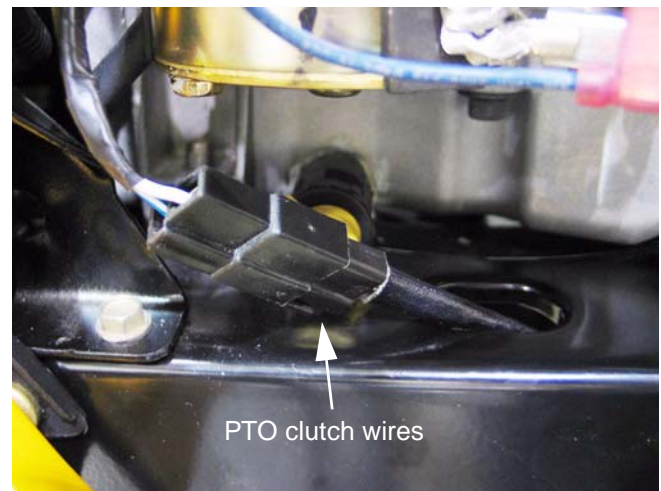

Figure 23.3

- 23.4. Remove the electric PTO clutch from the engine crankshaft using a 5/8" wrench. See Figure 23.4.

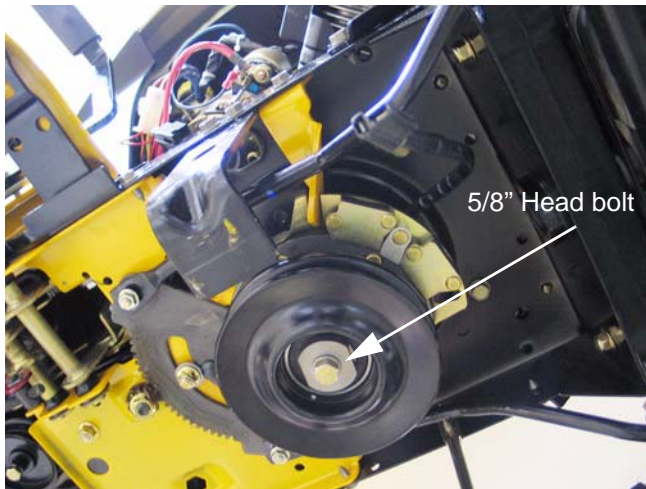

Figure 23.4

NOTE: Lower the clutch carefully, keeping track of the hardware on the crankshaft. There are variations between engines, clutches and years:

- Spacers above or below the traction drive pulley.
 - Integral or separate key on traction drive pulley.
 - Different PTO clutch anti-rotation brackets.
- 23.5. Slip the belt off of the single fixed idler. See Figure 23.5.



Figure 23.5

- 23.6. Carefully release the spring that maintains tension on the double idler bracket using a length of starter rope or an appropriate tool. See Figure 23.6.

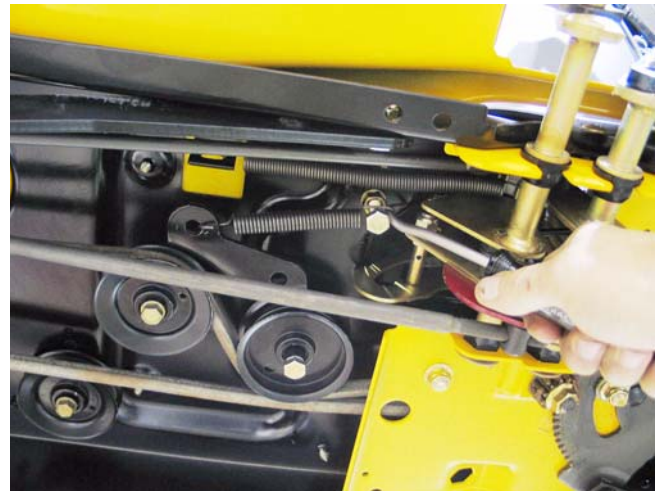

Figure 23.6

- 23.7. Slip the drive belt from between the double idler pulleys.

NOTE: On some early models, the rear-most pulley (rides against V side of belt) was large enough that the double idler bracket acted as a belt keeper. On those models, it is necessary to loosen the nut and bolt that secure that pulley to the bracket in order to slip the belt past the edge of the bracket.

NOTE: Pulleys may be steel or plastic, depending on when the tractor was built.

Series 1000 and 1500

23.8. Slip the crankshaft pulley down far enough to get the belt off of the pulley, and remove the belt from the crankshaft. See Figure 23.8.

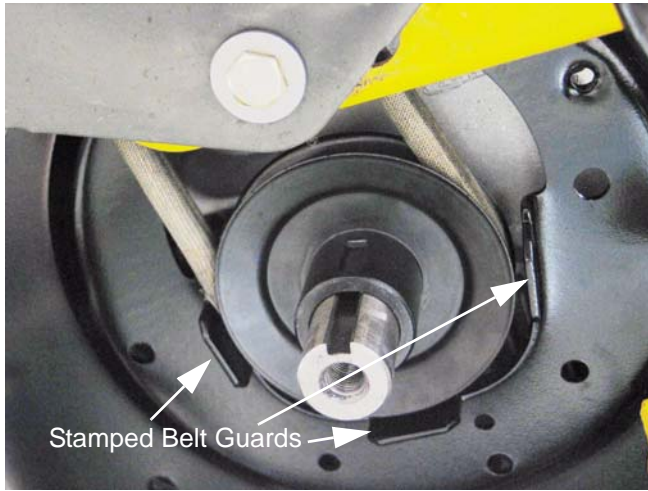

Figure 23.8

NOTE: Belt keepers that are part of the tractor frame prevent the belt from being removed without lowering the pulley.

NOTE: The pulley may be removed from the crankshaft at the discretion of the technician.

- If there is a spacer above the pulley, the end with the radiused inside edge mates with the radiused step on the crankshaft.
- If one end of the pulley has a radiused inside edge, that is the end that mates with the radiused step on the crankshaft.

23.9. Carefully work the belt over the top of the cooling fan on the transaxle, and remove it from the tractor. See Figure 23.9.

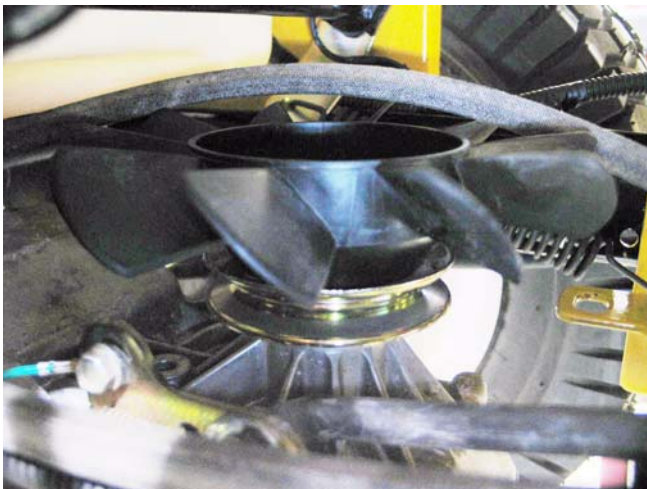

Figure 23.9

23.10. The belt for the G.T. models of the 1500 Series line is Kevlar wrapped. Substituting the poly-wrapped belt used on the L.T. models is not recommended, but the Kevlar belt is an acceptable premium upgrade for the L.T. tractors. See Figure 23.10.

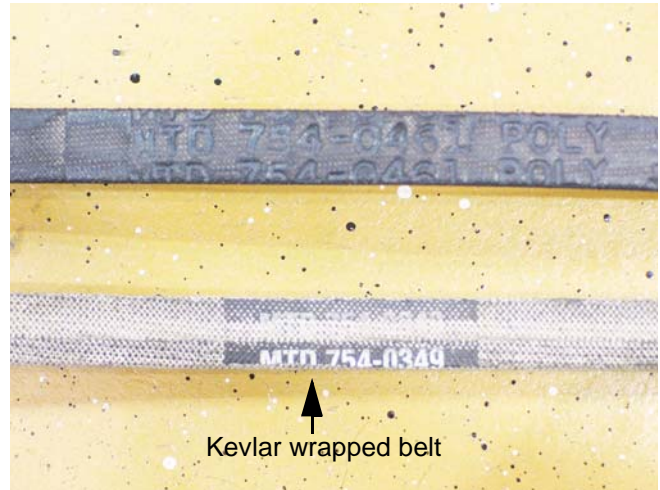

Figure 23.10

23.11. If the traction drive belt failed prematurely, identify the cause of its demise before installing a replacement. Check the condition of all of the idler pulleys.

23.12. The fixed idler pulley can be removed from later models using a single 1/2" wrench. The bolt that holds the fixed idler to earlier models threads into a 3/8" nut above the tractor frame. The bolt can be removed from the nut using a pair of 9/16" wrenches without removing the fenders. See Figure 23.12.

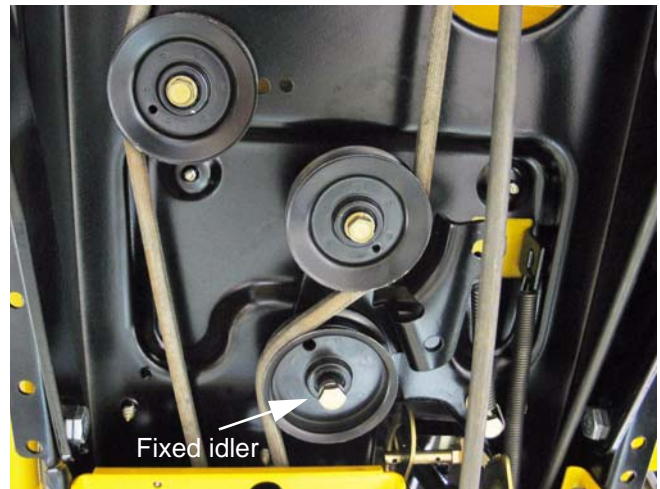

Figure 23.12

23.13. The double idler pivot bracket is held to the frame by the same bolt that holds the fore-most of the two pulleys. The rear pulley can be easily removed from the bracket. It is necessary to take the fenders off to remove the front pulley or the bracket itself.

23.14. Install the drive belt by reversing the order of the removal process.

- Apply anti-seize compound to the crankshaft before installing the PTO clutch.
- Tighten the crankshaft bolt to a torque of 38-50 ft.-lbs. on assembly.
- Test the drive system and all tractor safety features in a clear area that is free of hazards and by standers before returning the tractor to service.

24. DRIVE SYSTEM ADJUSTMENT: HYDROSTATIC LT

24.1. The relief valve is operated using a small rod that is visible at the bottom right corner of the rear of the tractor frame. See Figure 24.1.

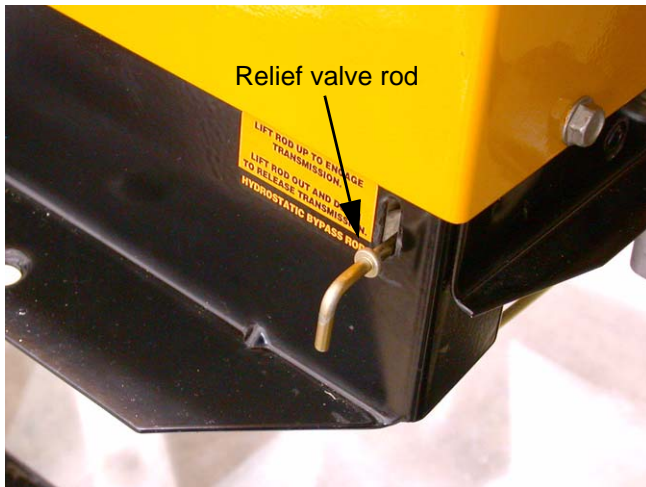

Figure 24.1

24.2. Pulling the rod out and locking it in the upper portion of the keyhole enables the tractor to be pushed, but disables the hydraulics of the drive system by opening a valve that releases the hydraulic pressure from the motor circuit.

24.3. There is no adjustment to the relief valve, but full travel of the linkage should be checked if the drive system is losing power or ground speed. See Figure 24.3.



Figure 24.3

24.4. **Symptoms** of a linkage that is out of adjustment include:

- **Low ground speed** in either direction with no unusual noises from the transaxle. One possible cause for low ground speed is a linkage that does not transfer all of the pedal travel to the input arm on the transaxle.
- **“Creeping”** when the transaxle is in neutral position.
- **Whining or growling** when the tractor is in Neutral with the brake applied.
- The creeping and whining symptoms usually accompany one-another, indicating that the linkage is not properly centered around Neutral.
- Low ground speed in one direction only (Forward or Reverse) may accompany whining, growling or creeping in Neutral if the linkage is out of adjustment.
- Low ground speed, accompanied by excessive noise is likely to be an internal problem or a brake that is dragging or out of adjustment.

24.5. Begin linkage adjustment by inspecting the linkage. Linkages on equipment that has been in the field are usually out of adjustment because the linkage is binding, worn, bent, or tampered with.

24.6. Replace any worn or damaged parts before adjusting the linkage.

Series 1000 and 1500

24.7. Turn-off the engine and allow it to cool before starting to work on the tractor. To gain access to the control linkage, perform the following three steps:

24.8. Remove the cutting deck.

24.9. Lift and safely support the rear of the tractor.

24.10. Remove the rear wheels using a 3/4" wrench.

24.11. Move the control pedal through it's range of travel (with the parking brake released) and look for the following conditions that will cause loss of linkage motion:

- Pedal loose on the pedal shaft.
- Loose arm that connects the pedal shaft to the control rod.
- Worn bushings supporting the pedal shaft.
- Worn ferrule or an elongated hole where ferrule connects to pedal shaft.

24.12. Disconnect the control rod from the pedal shaft by removing the cotter pin that secures the adjustable ferrule on the rod to the shaft. See Figure 24.12.

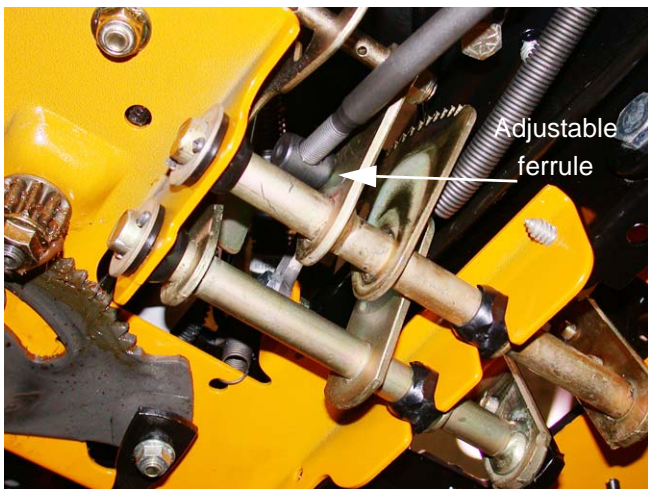

Figure 24.12

24.13. Confirm that the pedal shaft moves freely in the bushings, and does not bind.

24.14. Worn pedal shaft bushings are easily replaced using the following 5 steps.

NOTE: It is recommended to replace all four bushings at the same time.

24.15. Set the parking brake, and remove the drive pedal using a T-40 driver. See Figure 24.15.

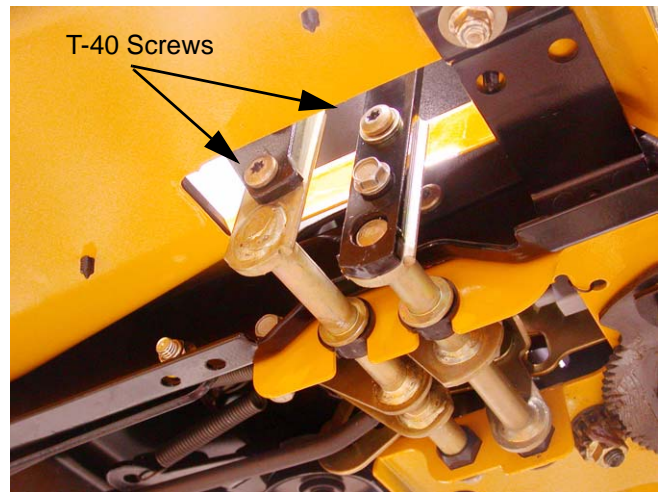

Figure 24.15

24.16. Remove and discard the cotter pins that hold the inboard bushing in place on both the speed control assembly and the brake control assembly. See Figure 24.16.

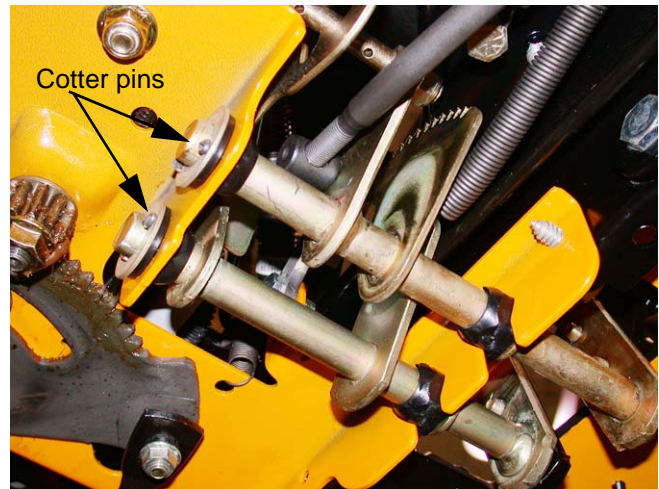

Figure 24.16

24.17. Remove the washers and inboard bushings from both shafts. See Figure 24.17.

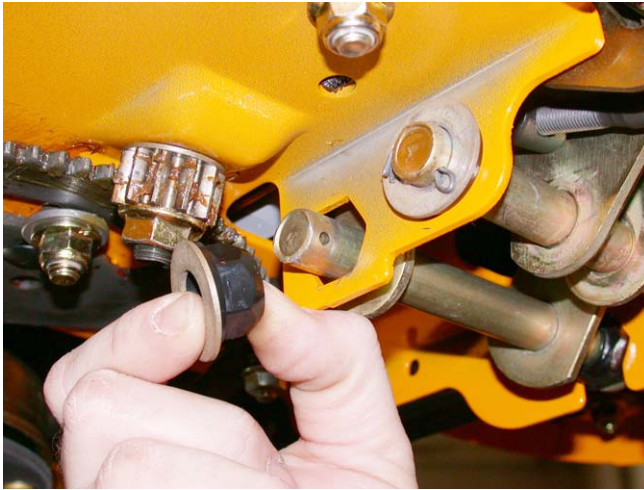

Figure 24.17

24.18. Slide both shafts outboard far enough to create clearance to remove the outer shaft bushings, and remove the bushings. See Figure 24.18.

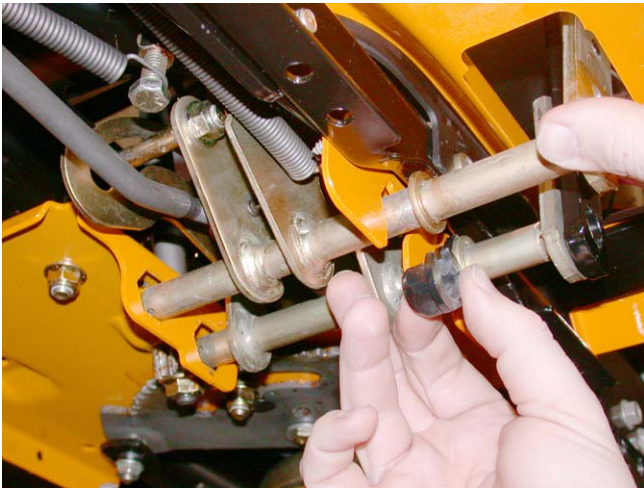

Figure 24.18

NOTE: The inner bushings are hex flange bushings. The outer bushings are similar, but are open on one side. The “tooth” in the top facet of the bracket that supports the bushing registers in the open side of each bushing.

24.19. Clean any corrosion or dirt from the surfaces where the pedal shaft contacts the bushing, and slip the new bushings into place.

NOTE: Lubrication with grease may accelerate bushing wear. If lubrication is applied it should be in dry form such as graphite or PTFE (Teflon).

24.20. Secure the pedal shafts with new cotter pins and previously removed washers.

24.21. Install the drive pedal, tightening the screw that secures it to a torque of 250 in.-lbs.

24.22. Move the pedal through its range of travel to check for bind. If binding is encountered:

- Bind in a portion of the travel may be caused by a bent pedal shaft.
- Constant bind is likely to be caused by a bent bracket.
- Also check for interference between the park brake and cruise control interlocks.

24.23. Correct any source of binding. The pedal shaft is easily removed at this point. The bracket may be straightened if damage is minor.

24.24. Confirm that no unsafe conditions will arise from starting the engine.

24.25. Start the engine, and operate it at top-no-load speed. Note the operation of the transaxle with the pedal linkage disconnected: An assistant may be required.

- Growling or whining with brake applied indicates that the input arm on the transaxle needs adjustment.
- Movement of the left rear wheel or the right drive hub with the brake released indicates that the input arm on the transaxle needs adjustment.
- With the hydro control rod disconnected from the pedal shaft, the input arm on the transaxle should return to Neutral.

24.26. If the transaxle does not return properly to neutral, adjust the input arm to correct the issue, then proceed with the following step. Review the next section for procedures.

24.27. If the transaxle returns properly to neutral:

- Adjust (if necessary) and reconnect the hydro control rod.
- Install the right rear wheel on the tractor, tightening the lug nuts to a torque of 350 - 500 in.-lbs.
- Lower the tractor to the ground and test the operation of the drive system in a safe area that is free of hazards, obstacles, and by-standers.
- Install the cutting deck, test all safety features, and return the tractor to service if everything works properly.

Series 1000 and 1500

25. HYDRO CONTROL ROD ADJUSTMENT

- If the unit “creeps” in the neutral position, one of two things may have happened: 1. The hydro control rod has been bent, causing the unit to creep or 2. The neutral position adjustment on the hydro has changed.

25.1. Set the parking brake. The cam in the parking brake mechanism will lock the pin on the pedal shaft into neutral. See Figure 25.1.

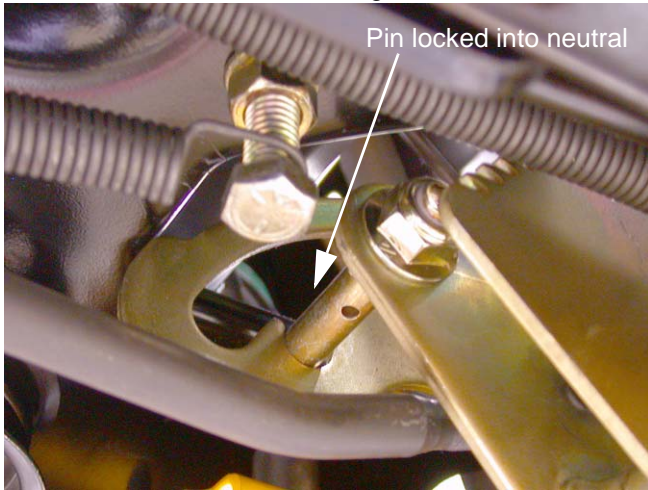

Figure 25.1

- 25.2. There should now be no tension on the hydro control rod. If there appears to be tension, look for a damaged or bent rod.
- 25.3. Remove the cotter pin securing the ferrule to the pivot arm on the pedal shaft.
- 25.4. Remove the ferrule from the hole in the arm. There should be no tension on the rod where it connects to the pivot arm.

25.5. If there is, thread the ferrule up or down the length of the hydro control rod until the post is centered in the hole that it fits into. At this point, the transaxle and the linkage should both be synchronized in neutral. See Figure 25.5.

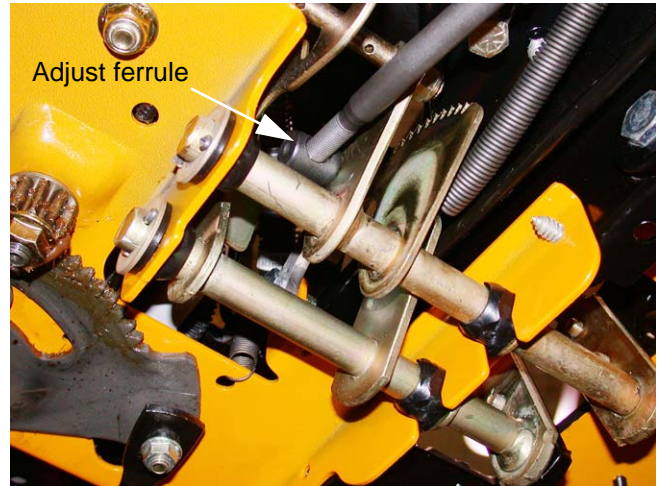

Figure 25.5

- 25.6. Secure the ferrule to the arm on the pedal shaft using a new cotter pin.
- 25.7. Test drive the unit to see if it still creeps. If it does you will have to adjust the input arm on the hydro: Confirm that the roller on the return arm draws fully into the valley in the cam surface on the front of the input arm. See Figure 25.7.

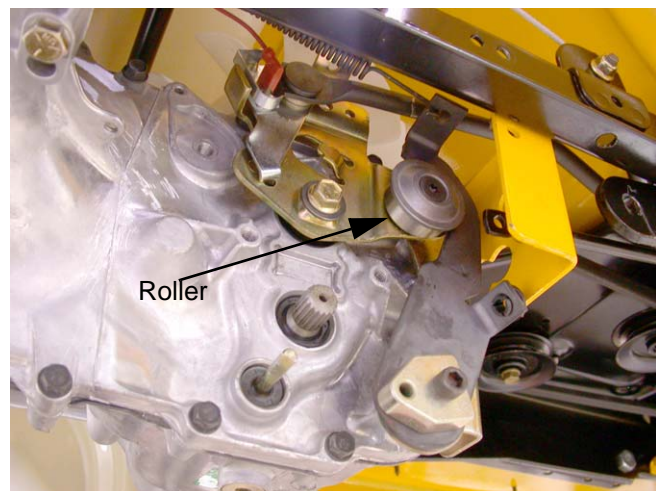

Figure 25.7

25.8. As the hydro control rod moves back on the input arm, it first moves a ground contact against the reverse safety switch. See Figure 25.8.

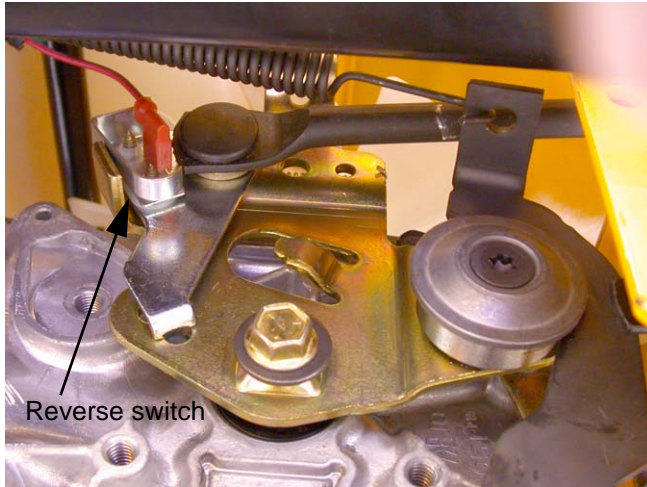

Figure 25.8

25.9. After the switch contacts the ground, the hydro control rod reaches the end of the lost-motion slot, and begins to push the arm forward, to the reverse position. Excessive lost motion will result in loss of ground speed in reverse.

25.10. As the hydro control rod is pushed rearward, it draws the cam (front) surface of the input arm upward, forcing the neutral return arm forward, applying more tension to the return spring. See Figure 25.10.

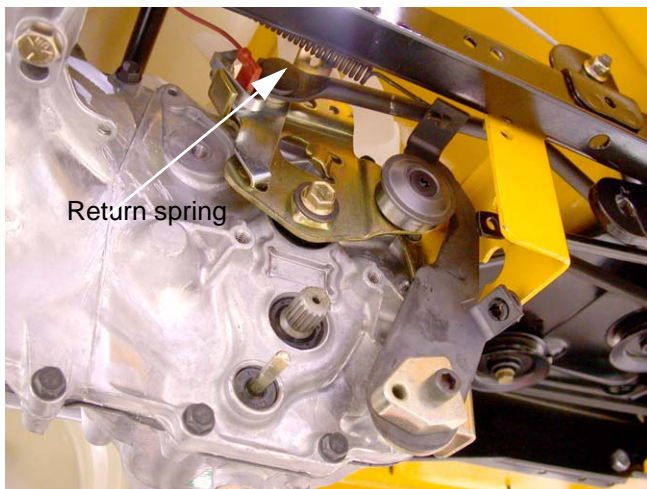

Figure 25.10

25.11. The point that the neutral return arm draws the input arm to is determined by the position of the roller on the neutral return arm:

- If the roller is moved higher, the input arm will move in the direction that causes forward drive.

- If the roller is moved lower, the input arm will move in the direction that causes reverse drive.

25.12. The roller is moved up or down by rotating the house-shaped eccentric that the neutral return arm pivots on. See Figure 25.12.



Figure 25.12

25.13. Loosen the eccentric using a 1/4" Allen wrench, and rotate it to adjust the roller up or down, as required to center the input arm in neutral.

25.14. Tighten the socket head cap screw to lock the adjustment, and check to confirm that the adjustment is correct.

25.15. After confirming that the transaxle is correctly adjusted:

- Adjust and reconnect the hydro control rod if it has been removed.
- Install the right rear wheel on the tractor if it was removed.
- Test the operation of the drive system in a safe area that is free of hazards, obstacles, and bystanders.
- Install the cutting deck, test all safety features, and return the tractor to service if everything works properly.

26. BRAKES AND BRAKE ADJUSTMENT: HYDROSTATIC LT

26.1. On hydrostatic garden tractors, most of the braking force is generated within the transaxle: when in Neutral, with the brakes released, the tractor will still be very difficult to push unless the relief valve has been opened. The brake functions mainly as a parking brake.

Series 1000 and 1500

- 26.2. When properly adjusted, the brake should do two things: it should stop and hold the tractor when applied, and it should not drag when released.
- 26.3. To check that the brakes hold the tractor:
- Open the relief valve.
 - Set the parking brake.
 - Attempt to push the tractor.
 - The wheels should skid without rotating.
 - If the brakes do not hold the tractor, the adjustment needs to be tightened or the brakes need to be repaired.
- 26.4. To check that the brakes do not drag:
- Open the relief valve.
 - Release the parking brake.
 - Attempt to push the tractor - it should move with about 40 lbs of force. More force indicates drag.
 - If the brakes drag, they need to be adjusted or repaired.
- 26.5. There is no linkage adjustment. All adjustment is done at the brake caliper.
- 26.6. To reach the brake caliper, lift and safely support the right rear corner of the tractor.
- 26.7. Remove the right rear wheel of the tractor using a 3/4" wrench.
- 26.8. Hydro-Gear transaxles use a castle nut locked with a cotter pin. See Figure 26.8.

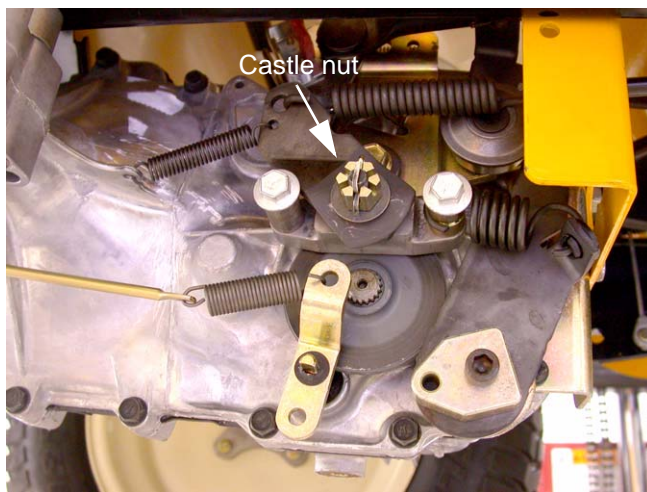

Figure 26.8

- 26.9. Insert a .015" feeler gauge between the brake rotor and the outer brake pad. There should be slight drag on the feeler gauge.
- 26.10. If the feeler gauge is too loose, or will not go in, brake caliper adjustment is necessary.
- 26.11. Remove and discard the cotter pin. A 9/16" wrench will turn the adjustment nut. See Figure 26.11.

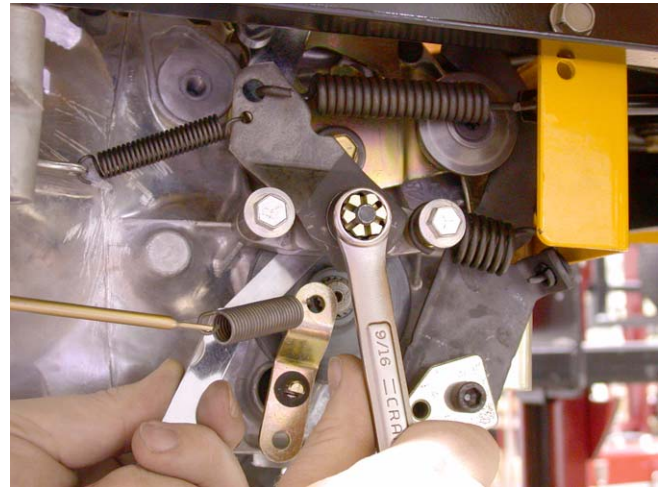

Figure 26.11

- 26.12. Tighten the nut to reduce the clearance. Loosen the nut to increase the clearance.
- 26.13. Check the movement of the brake arm:
- The brake arm should move forward as the brake is applied.
 - The return spring should draw the brake arm back against the spacer when the brakes are released.
- 26.14. Visually check the thickness of the brake pads: they are visible within the caliper.
- 26.15. Check the brake rotor:
- Confirm that the brake rotor floats on the splined shaft by sliding it in and out with light finger pressure.
 - If it binds on the shaft it may cause brake drag and reduced holding performance.
 - A rotor that has been dragging will frequently be discolored by the heat (blue).

26.16. If the brakes are dragging or worn, or if the rotor needs to be removed from the shaft disconnect the brake return spring where it attaches to the transmission housing. See Figure 26.16.

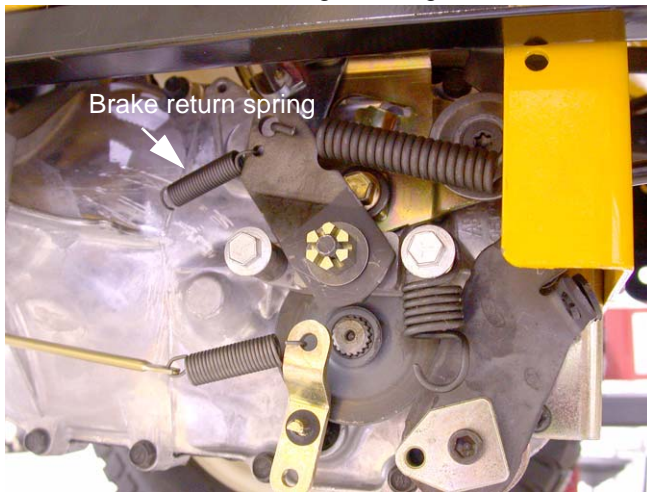

Figure 26.16

26.17. Using a suitable tool, remove the large hydro return spring where it attaches to the hydro arm.

26.18. Using a 7/16" wrench, remove the two bolts that hold the caliper to the transaxle. See Figure 26.16.

26.19. Once the caliper is removed from the transaxle, the brake arm can be unhooked from the spring that connects it to the brake linkage. See Figure 26.19.

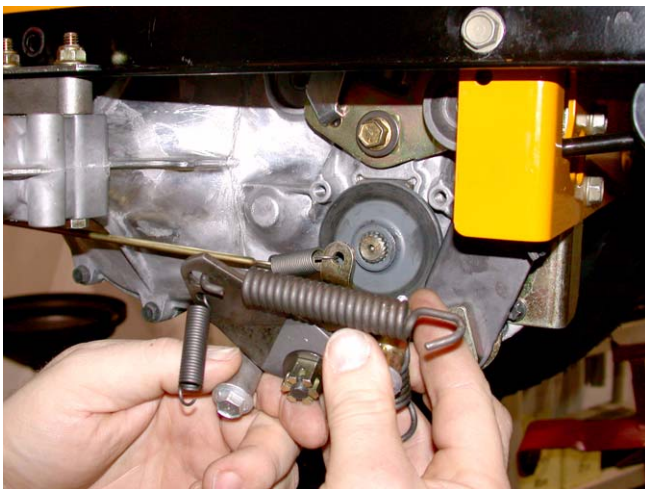

Figure 26.19

26.20. In order to remove the rotor and gain access to the fixed brake pad you will have to pry the retaining clip securing the hydro relief arm to the hydro relief valve shaft. See Figure 26.20.

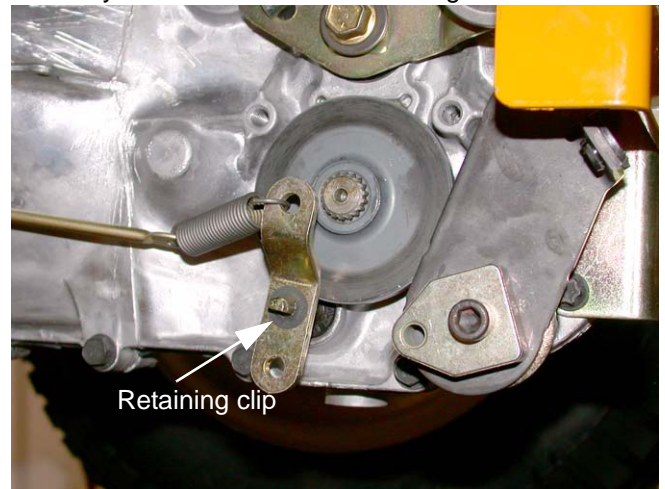

Figure 26.20

NOTE: During re-assembly you will have to replace the retaining clip with a new one.

26.21. The brake rotor should slide-off of the splined shaft, providing access to the fixed brake pad. See Figure 26.21.

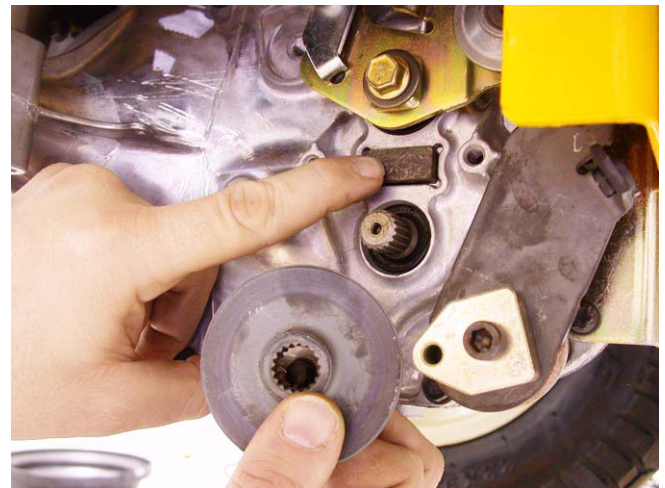

Figure 26.21

Series 1000 and 1500

26.22. The crease in the brake arm acts as a cam:
See Figure 26.22.



Figure 26.22

- The brake arm pivots on a square-headed stud.
- The two pins are forced against the backing plate when force is applied to the arm.
- The backing plate rides between the pins and the pad, to prevent the pins from working through the brake pad.

26.23. Replace the pads if they are worn. They frequently last many years unless the brakes have been dragging.

26.24. Be sure the pin bores are clear of dirt and corrosion: either may cause the pins to bind and the brakes to drag.

26.25. On assembly, apply a sparing amount of dry graphite lubricant to the pins and the spots on the brake arm that they contact. Do not allow any lubricant to get on the brake pad.

26.26. Install the brake caliper, tightening the two bolts to 7 to 10 ft.-lbs., then check and adjust the pad-to-rotor clearance. See Figure 26.11.

26.27. Lock the adjustment nut with a new cotter pin.

26.28. Install the rear wheel, tightening the lug nuts to a torque of 350 to 500 in.-lbs. Lower the tractor to the ground.

26.29. After any brake service is performed, test the brakes as described in steps 23.3 - 23.4 then test-drive the tractor in a safe area that is free of hazards, obstacles, and by-standers before returning the tractor to service.

26.30. If the brake is adjusted correctly and there is insufficient travel in the linkage to fully apply the

brakes, a simple visual inspection should identify the cause.

26.31. Confirm that the brake pedal is firmly attached to the pedal shaft. See Figure 26.31.

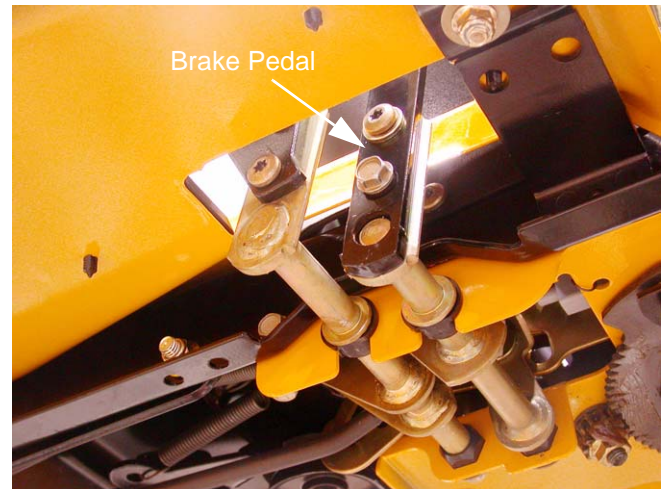

Figure 26.31

26.32. Remove the cutting deck to inspect the brake pedal shaft, bushings, and bracket.

26.33. Check for excessive play in the bushings. Replace them if they are worn.

27. PEDAL BUSHING REPLACEMENT

27.1. If any of the pedal bushings are worn, replace all the bushings.

27.2. Remove the brake pedal where it connects to the brake pedal shaft.

- 27.3. Remove and discard both cotter pins that secure the brake pedal shaft and the hydro drive pedal shaft to the frame. See Figure 27.3.

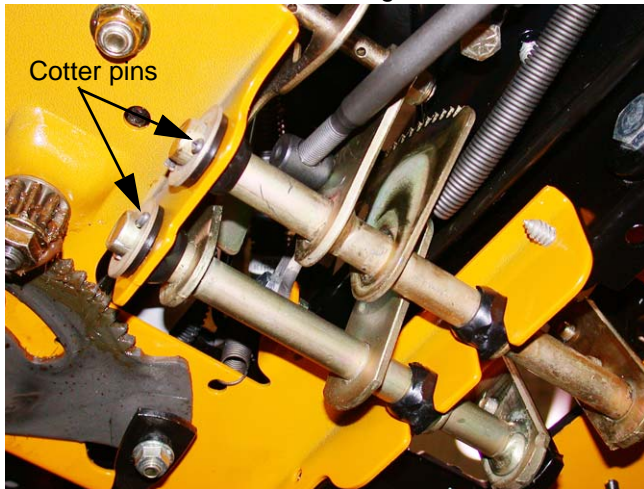

Figure 27.3

- 27.4. Remove the large washers and inner bushings from each shaft.
- 27.5. Press both shafts as far outward as possible, and pry the worn bushings out of the bracket. See Figure 27.5.

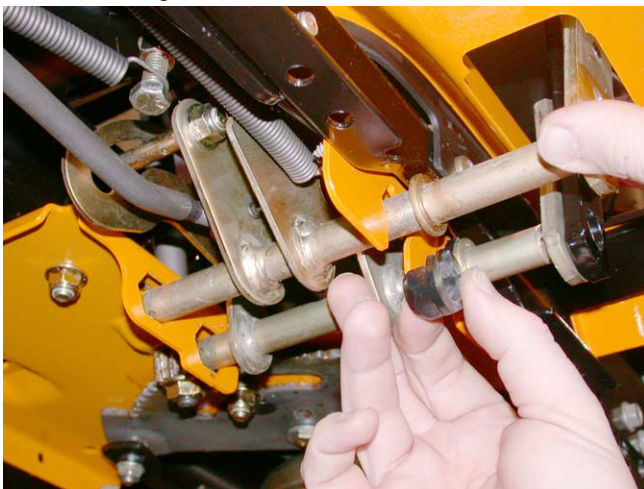

Figure 27.5

NOTE: A pair of vice-grips and a plate can be used to press the end of the shaft flush with the edge of the bracket to aid removal of the bushings.

NOTE: The inner bushing is a hex flange bushing. The outer bushing is similar, but has one open side. The “tooth” in the top facet of the bracket that supports the bushing registers in open side of the bushing.

- 27.6. Clean any corrosion or dirt from the surfaces where the pedal shafts contact the bushings, and slip the new bushings into place. See Figure 27.6.

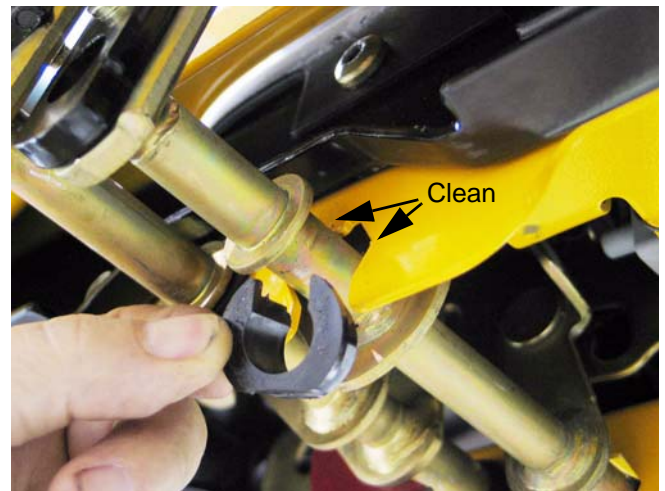

Figure 27.6

NOTE: Lubrication with grease may accelerate bushing wear. If lubrication is applied it should be in dry form such as graphite or PTFE (Teflon).

- 27.7. Secure the inner bushings with new cotter pins and the flat washers that were previously removed.
- 27.8. Move the pedal through its range of travel to check for bind. If binding is encountered:
- Bind in a portion of the travel may be caused by a bent pedal shaft.
 - Constant bind is likely to be caused by a bent bracket.
 - Also check for interference between the park brake and cruise control interlocks.
- 27.9. Correct any binding condition.
- 27.10. Connect the brake rod to the brake pedal shaft, and secure it with a new cotter pin.
- 27.11. After any brake service is performed, test the brakes as described in Section 23, then test-drive the tractor in a safe area that is free of hazards, obstacles, and by-standers before returning the tractor to service.
- 28. TRANSAXLE SERVICE AND MAINTENANCE: HYDROSTATIC LT**
- 28.1. In normal use, the transaxle should last the life of the tractor with minimal maintenance.

Series 1000 and 1500

- 28.2. Because the transaxle dissipates heat through air-cooling of the housing, it must be kept clean of dirt and debris, and the cooling fan should be replaced immediately if damaged.
- 28.3. Cleanliness is vitally important when doing any service work that might expose the fluid or internal parts to any form of contamination. Clean thoroughly around any fittings, parts, or seals that are to be removed prior to removal.
- 28.4. Pressure washing is not recommended, and may contaminate the transmission fluid. Damage caused by contaminated fluid is not warrantable.
- 28.5. Before commencing internal repairs, eliminate all possible external performance issues:
- Dragging brake
 - Maladjusted linkage
 - Partially open relief valve
 - Slipping traction drive belt/ low engine speed
- 28.6. The transaxle contains .600 to .632 gal of 20W-50 motor oil with an API classification of SH/CD.
- 28.7. Fill through the port at the top of the transaxle. Fluid will spill into the plastic over-flow reservoir as the fluid capacity is reached. See Figure 28.7.

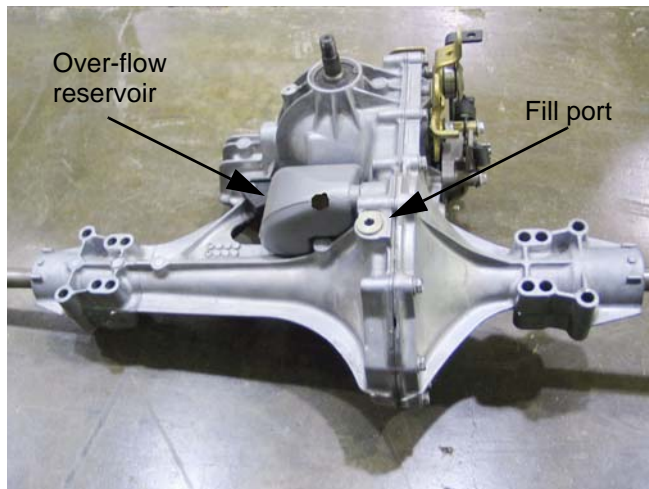

Figure 28.7

NOTE: Some transaxles may be painted black, depending on the year of production.

NOTE: The plastic over-flow reservoir has a plastic vent cap at the top. This is strictly a vent cap. Attempting to add fluid through the vent cap

will fill the over-flow reservoir, but will not add to the level of fluid in the transaxle.

NOTE: This oil (fluid) should not have to be changed in the normal service life of the transaxle unless it develops a leak or becomes contaminated.

- 28.8. If the transaxle develops a leak, identify and repair the leak to prevent further damage.
- 28.9. To drain the oil, Hydro-Gear recommends removal of the transaxle, for draining through the fill port.
- 28.10. A new addition to the transaxle is a drain plug. Depending on the date of manufacture, this plug may or may not be present. See Figure 28.10.

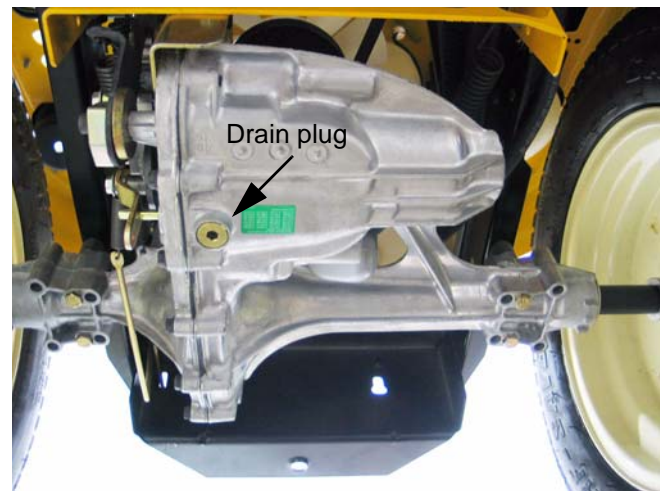

Figure 28.10

- 28.11. Any time the fluid has been drained from a hydrostatic transaxle, the air should be purged from the system on initial start-up.
- 28.12. **To purge** the air from the hydraulic system in the transaxle:
- Open the relief valve.
 - Start the engine.
 - Slowly cycle the drive pedal from full speed forward to full speed reverse 5 or 6 times, taking about 10 seconds to complete a single cycle.
 - Stop the engine and check the fluid level at the fluid level port near the back of the right side axle housing. The plug can be removed with a 1/4" Allen wrench. Top-up as necessary.
 - Close the relief valve.
 - Start the engine.

- Repeat as necessary until the transaxle operates normally.
- 28.13. Any service beyond fluid change requires removal substantial disassembly of the transaxle. Refer to Hydro-Gear manual BLN-52261 for complete repair instructions.

**29. TRANSAXLE REPLACEMENT:
HYDROSTATIC LT**

- 29.1. Warrantable failures on Cub Cadet tractors are to be repaired by replacing the transaxle. Failed, warrantable transaxles will be called-back through Cub Cadet's vendor recovery system. Failures of Hydro-Gear transaxles are rare.
- 29.2. Outside of warranty, Hydro-Gear transaxles may be repaired or replaced at the discretion of the customer and servicing dealer.
- 29.3. Before condemning a transaxle, eliminate all possible external performance issues:
- Dragging brake
 - Maladjusted linkage
 - Partially open relief valve
 - Slipping traction drive belt/ low engine speed
- 29.4. Remove the cutting deck to gain access to the linkages that will need to be disconnected.
- 29.5. Lift and safely support the rear of the tractor.
- 29.6. Remove the rear hub caps, then the rear wheels using a 3/4" wrench.
- 29.7. Remove the rear hub caps, then the rear wheels using a 3/4" wrench. See Figure 29.7.



Figure 29.7

- 29.8. Disconnect the front of the brake rod from the brake pedal shaft by removing the cotter pin, and pulling the "L" at the forward end of the rod out of the hole in the brake pedal shaft. See Figure 29.8.

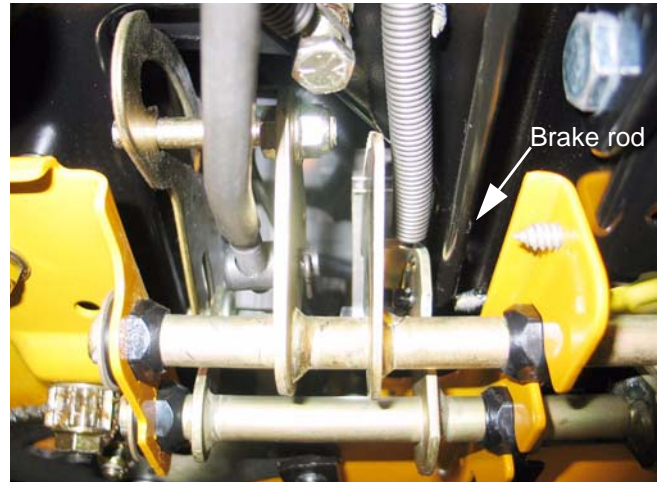

Figure 29.8

- 29.9. Disconnect the ferrule at the forward end of the speed control rod from the speed control pedal shaft in similar fashion.
- 29.10. Unplug the wire from the reverse safety switch (Red wire w/black trace on Rev-Tek equipped models, Yellow wire w/black trace on others).
- 29.11. Disconnect the ground wire from the transaxle using a 3/8" wrench.
- 29.12. Remove the fan from the input pulley on the transaxle using 5/16" wrench. See Figure 29.12.

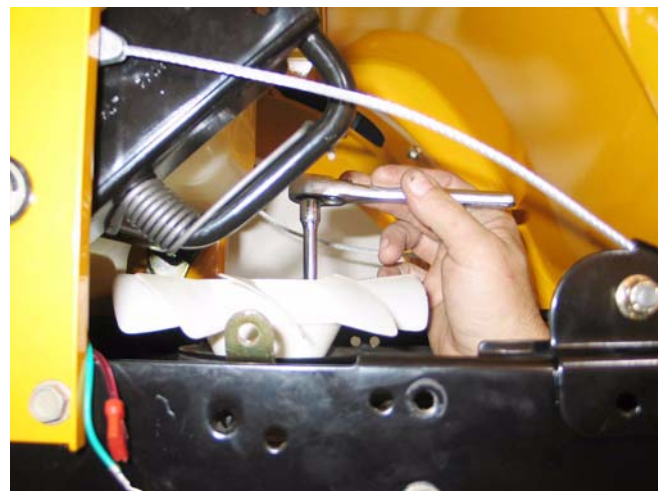

Figure 29.12

Series 1000 and 1500

29.13. Draw the traction drive belt off of the fixed idler pulley to create slack, then work the belt off of the double idler pulleys, similar to the method described in the "TRACTION DRIVE BELT: HYDROSTATIC LT" section of this manual.

29.14. Slip the belt off of the input pulley.
See Figure 34.15.



Figure 29.14

29.15. Disconnect the hydro relief rod from the relief valve by unhooking the extension spring that joins the rod to the arm that operates the valve.
See Figure 29.15.



Figure 29.15

29.16. Maneuver the rod to a position where it will not interfere with nor be damaged by the removal of the transaxle.

29.17. Disconnect the deck lift assist spring that hooks to the left side of the transaxle torque bracket using a length of starter rope or a spring removal tool.
See Figure 29.17.



Figure 29.17

29.18. Disconnect the heavy return spring that pulls the control arm toward the rear of the tractor.
See Figure 29.18.

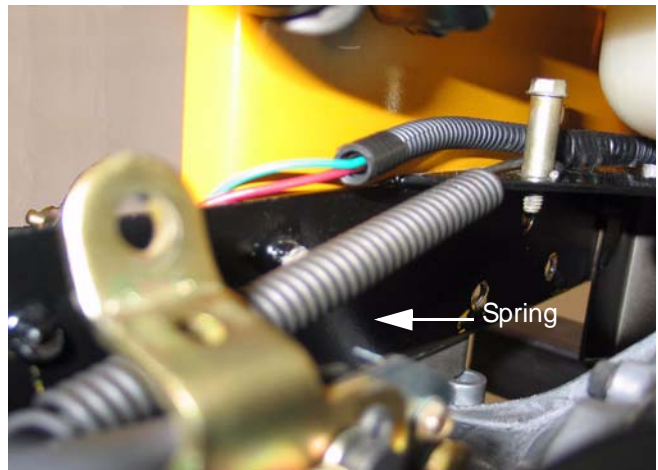

Figure 29.18

29.19. A length of starter rope is best used to disconnect the front of the spring from the control arm. pass the rope over the torque bracket, and draw downward on the rope to avoid destabilizing the tractor. See Figure 29.19.



Figure 29.19

29.20. Support the transaxle with a hydraulic jack.

29.21. Remove the two screws that connect the stabilizer bracket to the frame using a 1/2" wrench. See Figure 29.21.

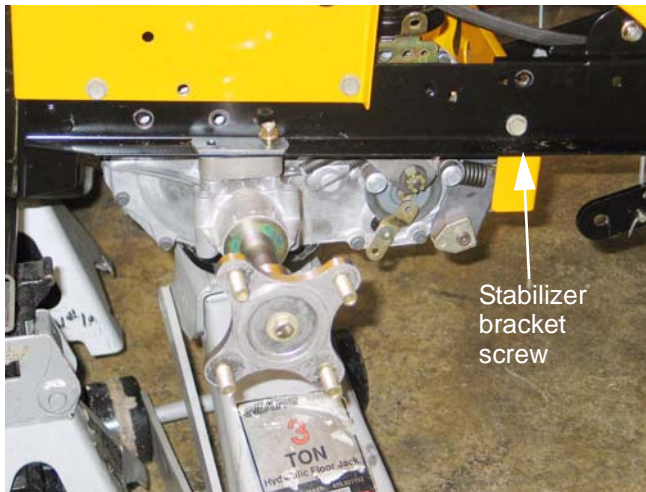

Figure 29.21

29.22. Remove the pair of nuts and bolts that fasten each axle housing of the transaxle to the tractor frame. Use a pair of 1/2" wrenches.

NOTE: The bolts pass through a steel reinforcement (sister) plate above the lip on the tractor frame, and an aluminum spacer that fits between the frame and the axle housing.

29.23. Carefully lower the transaxle to the ground, complete with torque bracket, brake rod, and hydro control rod. See Figure 29.23.



Figure 29.23

29.24. Installation notes are as follows:

29.25. Fill the transaxle with fluid before installing it in the tractor. Some dealers have devised ways to manually drive the input shaft and purge the air from the drive system on the bench, prior to installation.

29.26. If bench purging is not available, follow the purging instructions described in the "TRANSAXLE SERVICE AND MAINTENANCE: HYDRO-STATIC GT" section of this manual after the transaxle is installed.

29.27. Reverse the removal process to install the transaxle.

- Tighten the screws to the torque bracket to a torque of: 35 ft.-lbs.
- Tighten the bolts holding the axle housings to the frame to a torque of: 250 in.-lbs.
- Tighten the screws holding the fan to the pulley to a torque of: 30-35 in.-lbs.
- Tighten the lug nuts to a torque of:

29.28. Test run the tractor in a safe area that is free of hazards, obstacles, and bystanders to confirm correct operation and adjustment before installing the cutting deck. Make any necessary adjustments.

29.29. Test run the tractor in a safe are that is free of obstacles, hazards, and bystanders after the cutting deck is installed. Check all safety features before returning the tractor to service.

Series 1000 and 1500

30. TRACTION DRIVE BELT REPLACEMENT: HYDROSTATIC GT

- 30.1. Turn-off the engine and allow all parts to cool before beginning work.
- 30.2. Remove the cutting deck.
- 30.3. Identify and unplug the wires leading to the electric PTO clutch. See Figure 30.3.

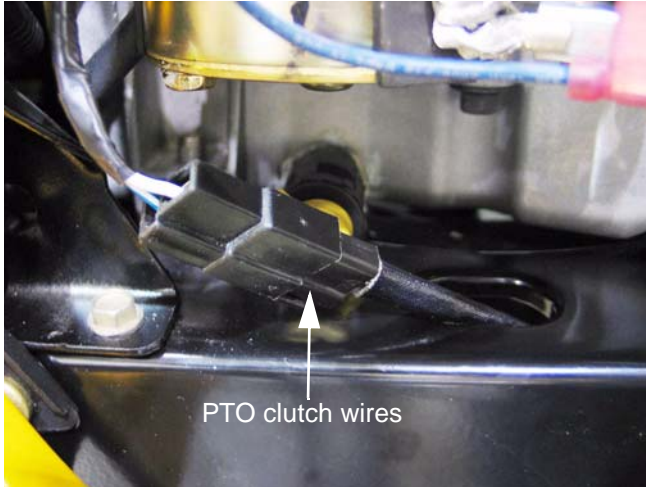

Figure 30.3

- 30.4. Remove the electric PTO clutch from the engine crankshaft using a 5/8" wrench. See Figure 30.4.

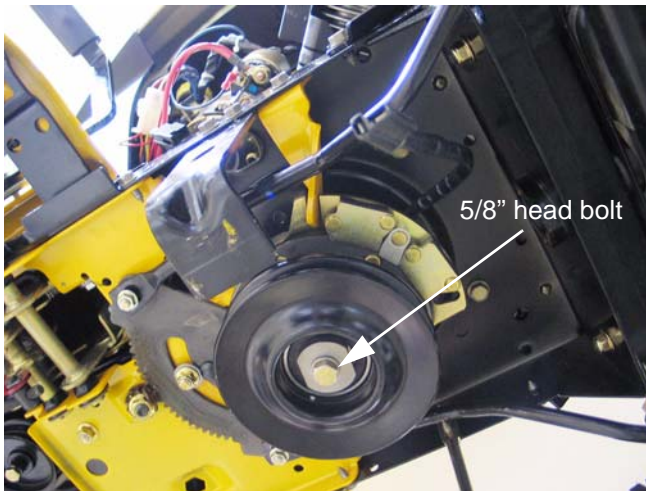

Figure 30.4

NOTE: Lower the clutch carefully, keeping track of the hardware on the crankshaft. There are variations between engines, clutches and years:

- Spacers above or below the traction drive pulley.
- Integral or separate key on traction drive pulley.
- Different PTO clutch anti-rotation brackets.

- 30.5. Slip the belt off of the single fixed idler. See Figure 30.5.



Figure 30.5

- 30.6. Carefully release the spring that maintains tension on the double idler bracket using a length of starter rope or an appropriate tool. See Figure 30.6.

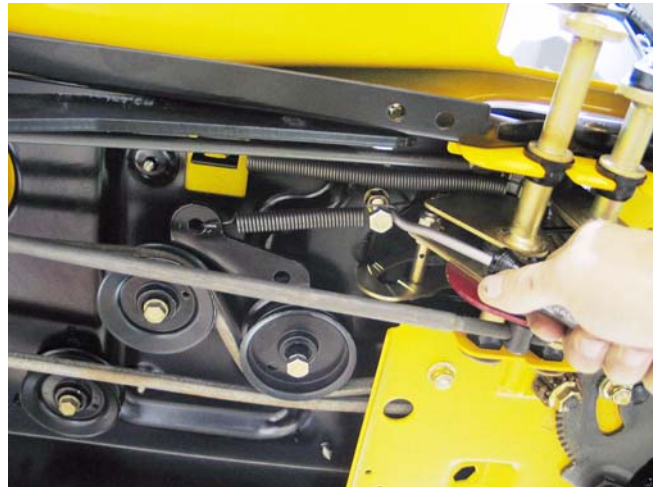

Figure 30.6

- 30.7. Slip the drive belt from between the double idler pulleys.

NOTE: On some early models, the rear-most pulley (rides against V side of belt) was large enough that the double idler bracket acted as a belt keeper. On those models, it is necessary to loosen the nut and bolt that secure that pulley to the bracket in order to slip the belt past the edge of the bracket.

NOTE: Pulleys may be steel or plastic, depending on when the tractor was built.

30.8. Slip the crankshaft pulley down far enough to get the belt off of the pulley, and remove the belt from the crankshaft. See Figure 30.8.



Figure 30.8

NOTE: Belt keepers that are part of the tractor frame prevent the belt from being removed without lowering the pulley.

NOTE: The pulley may be removed from the crankshaft at the discretion of the technician.

- If there is a spacer above the pulley, the end with the radiused inside edge mates with the radiused step on the crankshaft.
- If one end of the pulley has a radiused inside edge, that is the end that mates with the radiused step on the crankshaft.

30.9. Carefully work the belt over the top of the cooling fan on the transaxle, and remove it from the tractor. See Figure 30.9.



Figure 30.9

30.10. The belt for the G.T. models of the 1500 Series line is Kevlar wrapped. Substituting the poly-wrapped belt used on the L.T. models is not recommended, but the Kevlar belt is an acceptable premium upgrade for the L.T. tractors. See Figure 30.10.

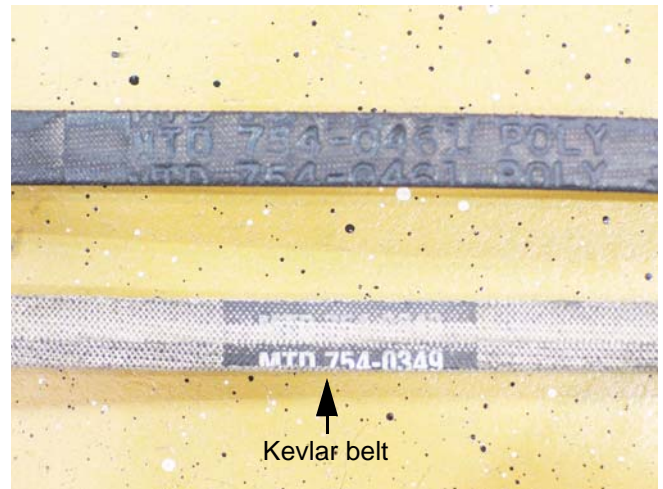

Figure 30.10

30.11. If the traction drive belt failed prematurely, identify the cause of its demise before installing a replacement. Check the condition of all of the idler pulleys.

30.12. The fixed idler pulley can be removed from later models using a single 1/2" wrench. The bolt that holds the fixed idler to earlier models threads into a 3/8" nut above the tractor frame. The bolt can be removed from the nut using a pair of 9/16" wrenches without removing the fenders. See Figure 30.12.

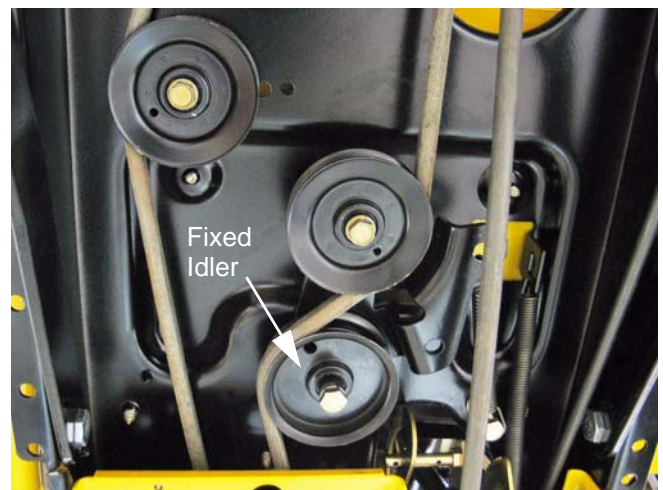

Figure 30.12

Series 1000 and 1500

30.13. The double idler pivot bracket is held to the frame by the same bolt that holds the fore-most of the two pulleys. The rear pulley can be easily removed from the bracket. It is necessary to take the fenders off to remove the front pulley or the bracket itself.

30.14. Install the drive belt by reversing the order of the removal process.

- Apply anti-seize compound to the crankshaft before installing the PTO clutch.
- Tighten the crankshaft bolt to a torque of 38-50 ft.-lbs. on assembly.
- Test the drive system and all tractor safety features in a clear area that is free of hazards and by standers before returning the tractor to service.

31. DRIVE SYSTEM ADJUSTMENT: HYDROSTATIC GT

31.1. The relief valve is operated using a heavy rod that is visible at the bottom left corner of the rear of the tractor frame. See Figure 31.1.

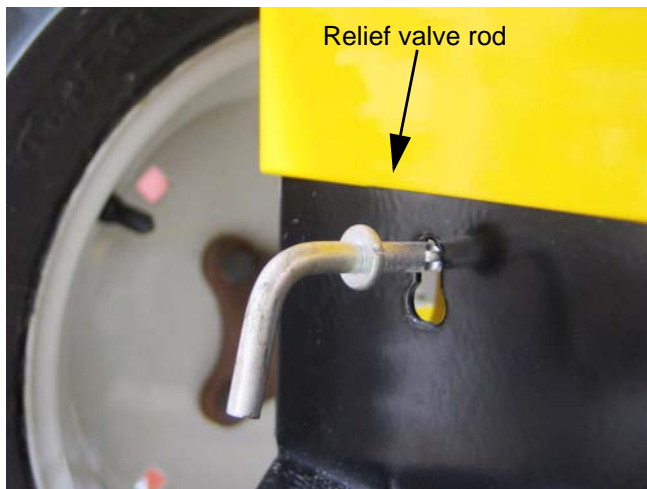

Figure 31.1

31.2. Pulling the rod out and locking it in the upper portion of the keyhole enables the tractor to be pushed, but disables the hydraulics of the drive system by opening a valve that releases the hydraulic pressure from the motor circuit.

31.3. There is no adjustment to the relief valve, but full travel of the linkage should be checked if the drive system is losing power or ground speed. See Figure 31.3.



Figure 31.3

31.4. **Symptoms** of a linkage that is out of adjustment include:

- **Low ground speed** in either direction with no unusual noises from the transaxle. One possible cause for low ground speed is a linkage that does not transfer all of the pedal travel to the input arm on the transaxle.
- **“Creeping”** when the transaxle is in neutral position.
- **Whining or growling** when the tractor is in Neutral with the brake applied.
- The creeping and whining symptoms usually accompany one-another, indicating that the linkage is not properly centered around Neutral.
- Low ground speed in one direction only (Forward or Reverse) may accompany whining, growling or creeping in Neutral if the linkage is out of adjustment.
- Low ground speed, accompanied by excessive noise is likely to be an internal problem or a brake that is dragging or out of adjustment.

31.5. Begin linkage adjustment by inspecting the linkage. Linkages on equipment that has been in the field are usually out of adjustment because the linkage is binding, worn, bent, or tampered with.

31.6. Replace any worn or damaged parts before adjusting the linkage.

31.7. Turn-off the engine and allow it to cool before starting to work on the tractor. To gain access to the control linkage, perform the following three steps:

31.8. Remove the cutting deck.

31.9. Lift and safely support the rear of the tractor.

31.10. Remove the rear wheels using a 3/4" wrench.

31.11. Move the control pedal through it's range of travel (with the parking brake released) and look for the following conditions that will cause loss of linkage motion:

- Pedal loose on the pedal shaft.
- Loose arm that connects the pedal shaft to the control rod.
- Worn bushings supporting the pedal shaft.
- Worn ferrule or an elongated hole where ferrule connects to pedal shaft.

31.12. Disconnect the control rod from the pedal shaft by removing the cotter pin that secures the adjustable ferrule on the rod to the shaft. See Figure 31.12.



Figure 31.12

31.13. Confirm that the pedal shaft moves freely in the bushings, and does not bind.

31.14. Worn pedal shaft bushings are easily replaced using the following 5 steps.

31.15. Set the parking brake and remove the drive pedal using a T-40 driver. See Figure 31.15.

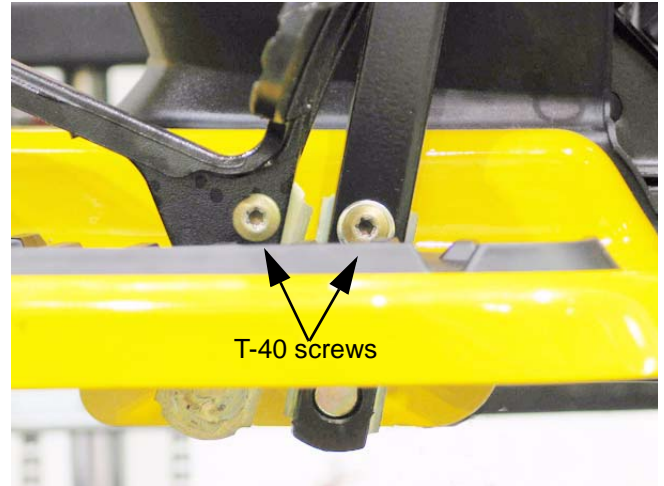

Figure 31.15

31.16. Remove and discard the cotter pin that holds the inboard bushing in place. See Figure 31.16.

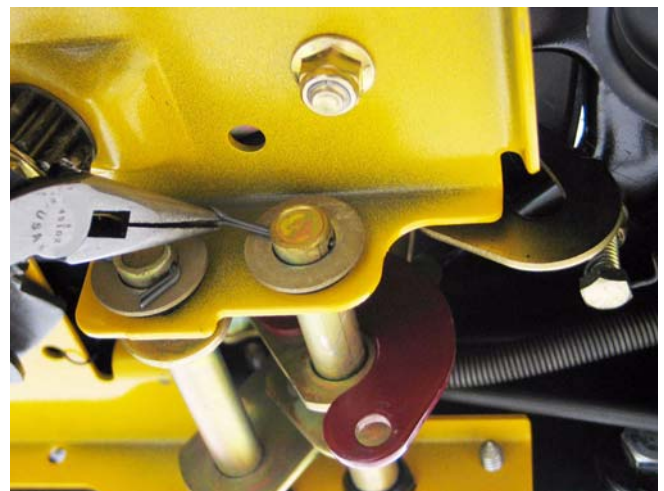

Figure 31.16

Series 1000 and 1500

31.17. Remove the washer and inboard bushing from the pedal shaft. See Figure 31.17.

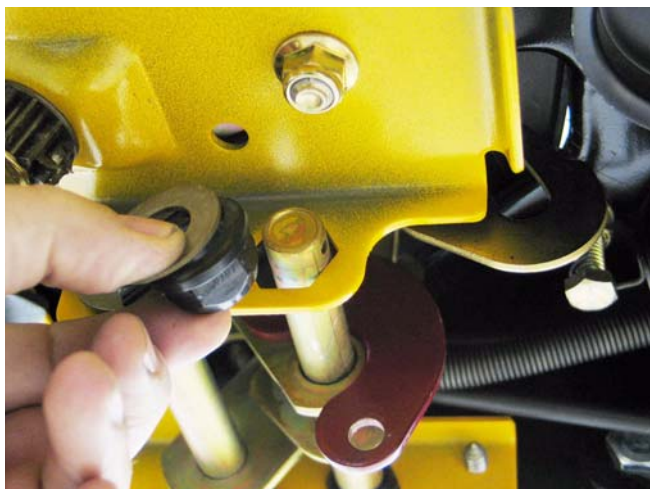

Figure 31.17

31.18. Slide the pedal shaft outboard far enough to create clearance to remove the outer pedal shaft bushing, and remove the bushing. See Figure 31.18.

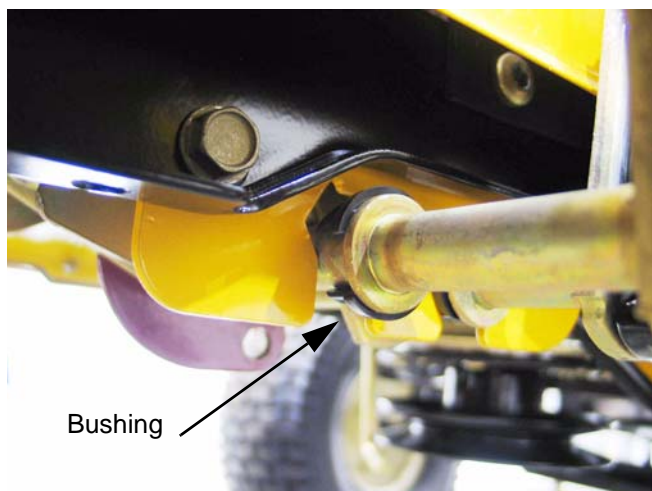

Figure 31.18

NOTE: The inner bushing is a hex flange bushing. The outer bushing is similar, but has one open side. The “tooth” in the top facet of the bracket that supports the bushing registers in open side of the bushing.

31.19. Clean any corrosion or dirt from the surfaces where the pedal shaft contacts the bushing, and slip the new bushings into place.

NOTE: Lubrication with grease may accelerate bushing wear. If lubrication is applied it should be in dry form such as graphite or PTFE (Teflon).

31.20. Secure the pedal shaft with a new cotter pin and previously removed washer.

31.21. Install the drive pedal, tightening the screw that secures it to a torque of 250 in-lbs.

31.22. Move the pedal through its range of travel to check for bind. If binding is encountered:

- Bind in a portion of the travel may be caused by a bent pedal shaft.
- Constant bind is likely to be caused by a bent bracket.
- Also check for interference between the park brake and cruise control interlocks.

31.23. Correct any source of binding. The pedal shaft is easily removed at this point. The bracket may be straightened if damage is minor.

31.24. Confirm that no unsafe conditions will arise from starting the engine.

31.25. Start the engine, and operate it at top-no-load speed. Note the operation of the transaxle with the pedal linkage disconnected: An assistant may be required.

- Growling or whining with brake applied indicates that the input arm on the transaxle needs adjustment.
- Movement of the left rear wheel or the right drive hub with the brake released indicates that the input arm on the transaxle needs adjustment.
- With the hydro control rod disconnected from the pedal shaft, the input arm on the transaxle should return to Neutral.

31.26. If the transaxle does not return properly to neutral, adjust the input arm to correct the issue, then proceed with the following step (23.27).

31.27. If the transaxle returns properly to neutral:

- Adjust and reconnect the hydro control rod as described in steps 23.28 through 23.30.
- Install the right rear wheel on the tractor, tightening the lug nuts to a torque of.
- Lower the tractor to the ground and test the operation of the drive system in a safe area that is free of hazards, obstacles, and by-standers.
- Install the cutting deck, test all safety features, and return the tractor to service if everything works properly.

31.28. **To adjust the hydro control rod:** Find the Neutral position for the control pedal, and set the parking brake. The cam in the parking brake mechanism will lock the pin on the pedal shaft into Neutral. See Figure 31.28.

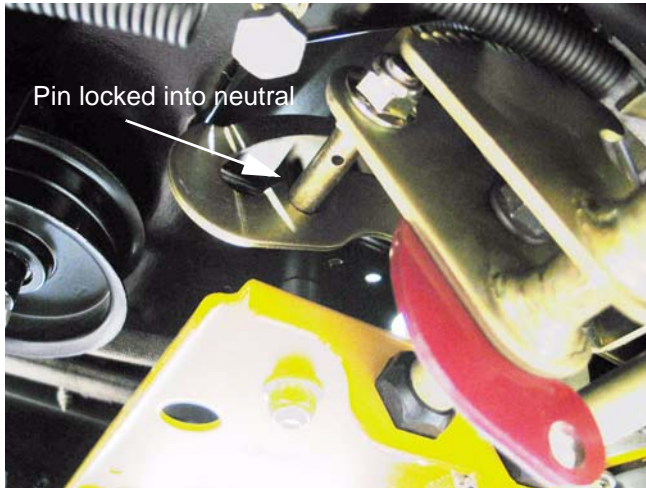

Figure 31.28

31.29. Thread the ferrule up or down the length of the hydro control rod until the post is centered in the hole that it fits into. At this point, the transaxle and the linkage are both synchronized in Neutral. See Figure 31.29.

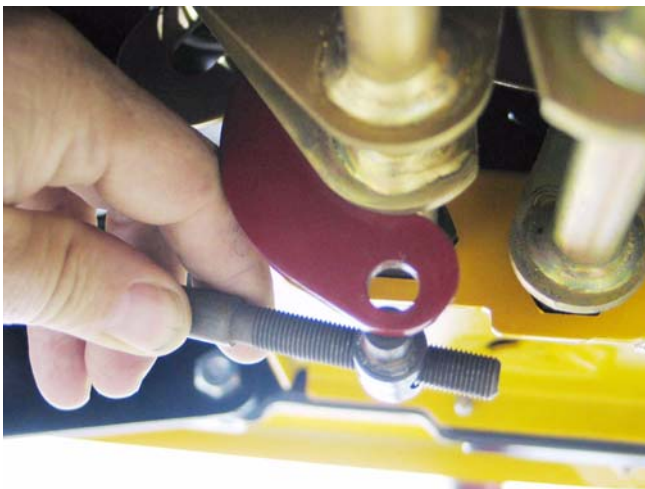

Figure 31.29

31.30. Secure the ferrule to the arm on the pedal shaft using a new cotter pin.

31.31. **To adjust the input arm on the hydro:** Confirm that the roller on the return arm draws fully into the valley in the cam surface on the front of the input arm. See Figure 31.31.

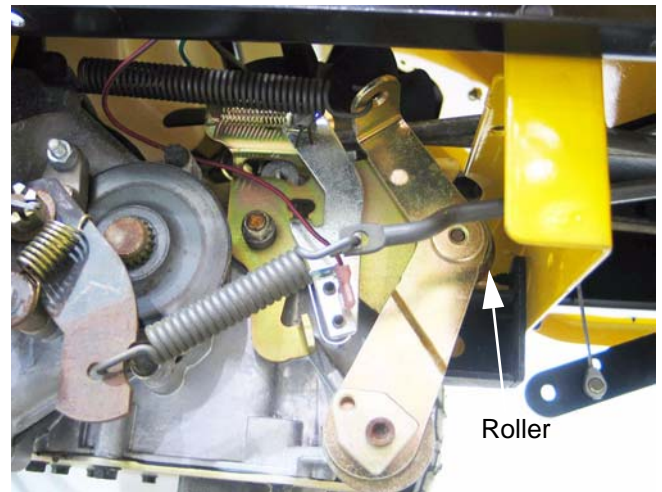

Figure 31.31

31.32. As the hydro control rod pulls forward on the input arm, it first moves a ground contact against the reverse safety switch. See Figure 31.32.

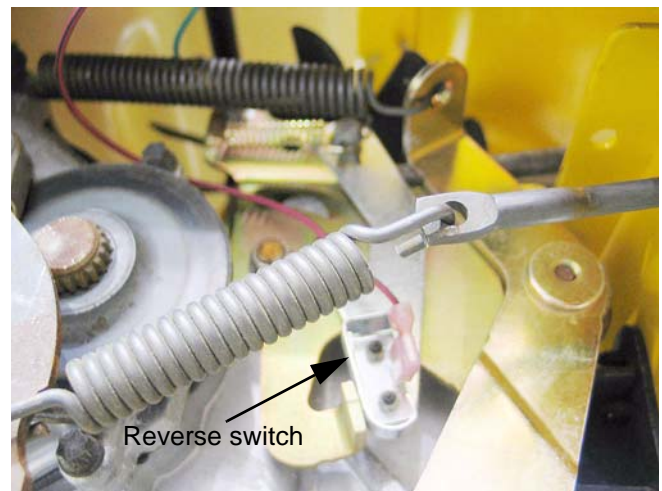

Figure 31.32

31.33. After the switch contacts the ground, the hydro control rod reaches the end of the lost-motion slot, and begins to push the arm forward, to the Reverse position. Excessive lost motion will result in loss of ground speed in reverse.

Series 1000 and 1500

31.34. As the hydro control rod is pushed rearward, it draws the cam (front) surface of the input arm upward, forcing the neutral return arm forward, applying more tension to the return spring. See Figure 31.34.

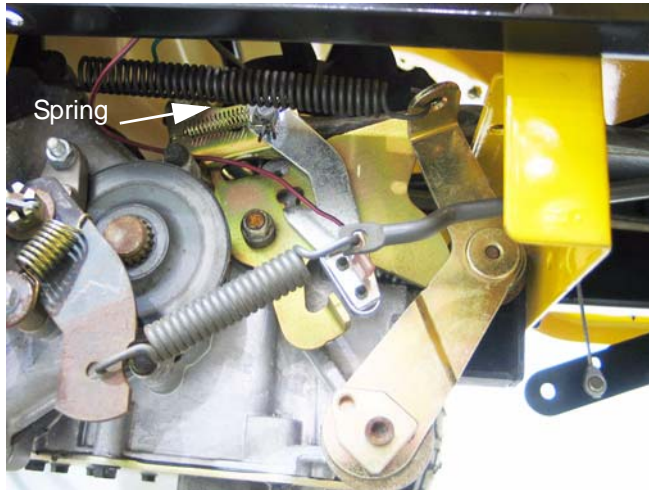

Figure 31.34

31.35. The point that the neutral return arm draws the input arm to is determined by the position of the roller on the neutral return arm:

- If the roller is moved higher, the input arm will move in the direction that causes forward drive.
- If the roller is moved lower, the input arm will move in the direction that causes reverse drive.

31.36. The roller is moved up or down by rotating the house-shaped eccentric that the neutral return arm pivots on. See Figure 31.36.



Figure 31.36

31.37. Loosen the eccentric using a 1/4" Allen wrench, and rotate it to adjust the roller up or down, as required to center the input arm in Neutral.

31.38. Tighten the socket head cap screw to lock the adjustment, and check to confirm that the adjustment is correct by repeating step 23.25.

31.39. After confirming that the transaxle is correctly adjusted:

- Adjust and reconnect the hydro control rod as described in steps 23.28 through 23.30.
- Install the right rear wheel on the tractor, tightening the lug nuts to a torque of.
- Lower the tractor to the ground and test the operation of the drive system in a safe area that is free of hazards, obstacles, and by-standers.
- Install the cutting deck, test all safety features, and return the tractor to service if everything works properly.

32. BRAKES AND BRAKE ADJUSTMENT: HYDROSTATIC GT

32.1. On hydrostatic garden tractors, most of the braking force is generated within the transaxle: when in Neutral, with the brakes released, the tractor will still be very difficult to push unless the relief valve has been opened. The brake functions mainly as a parking brake.

32.2. When properly adjusted, the brake should do two things: it should stop and hold the tractor when applied, and it should not drag when released.

32.3. To check that the brakes hold the tractor:

- Open the relief valve.
- Set the parking brake.
- Attempt to push the tractor.
- The wheels should skid without rotating.
- If the brakes do not hold the tractor, the adjustment needs to be tightened or the brakes need to be repaired.

32.4. To check that the brakes do not drag:

- Open the relief valve.
- Release the parking brake.
- Attempt to push the tractor - it should move with about 40 lbs of force. More force indicates drag.
- If the brakes drag, they need to be adjusted or repaired.

- 32.5. There is no linkage adjustment. All adjustment is done at the brake caliper.
- 32.6. To reach the brake caliper, lift and safely support the right rear corner of the tractor.
- 32.7. Remove the right rear wheel of the tractor using a 3/4" wrench.
- 32.8. Hydro-Gear transaxles use a castle nut locked with a cotter pin. See Figure 32.8.

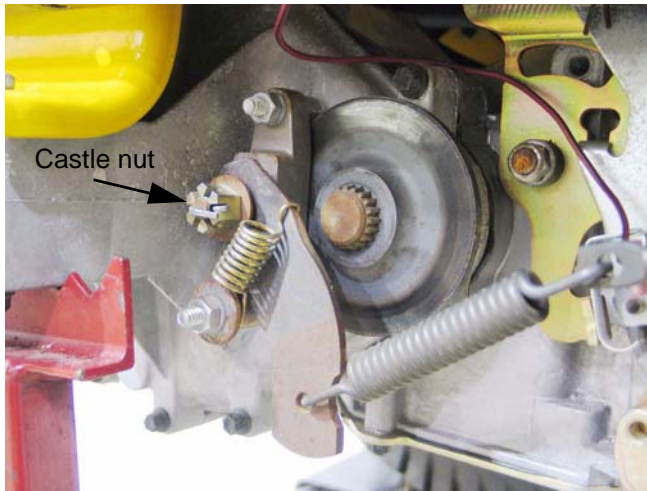

Figure 32.8

- 32.9. Insert a .015" feeler gauge between the brake rotor and the outer brake pad. There should be slight drag on the feeler gauge.
- 32.10. If the feeler gauge is too loose, or will not go in, brake caliper adjustment is necessary.
- 32.11. Remove and discard the cotter pin. A 1/2" wrench will turn the adjustment nut. See Figure 32.11.

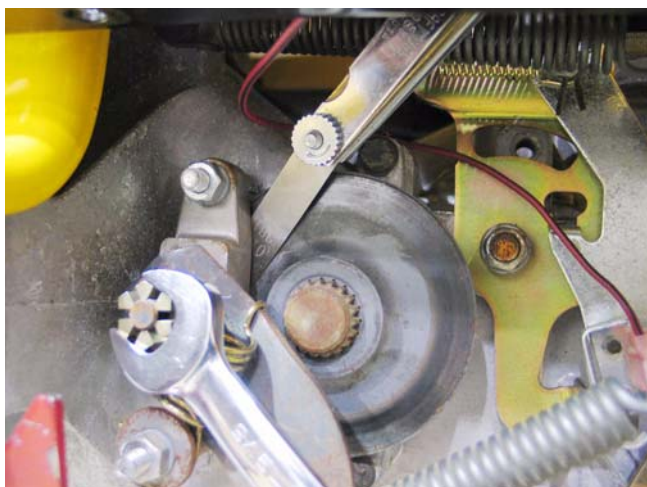

Figure 32.11

- 32.12. Tighten the nut to reduce the clearance. Loosen the nut to increase the clearance.
- 32.13. Check the movement of the brake arm:
 - The brake arm should move forward as the brake is applied.
 - The return spring should draw the brake arm back against the spacer when the brakes are released.
- 32.14. Visually check the thickness of the brake pads: they are visible within the caliper.
- 32.15. Check the brake rotor:
 - Confirm that the brake rotor floats on the splined shaft by sliding it in and out with light finger pressure.
 - If it binds on the shaft it may cause brake drag and reduced holding performance.
 - A rotor that has been dragging will frequently be discolored by the heat (blue).
- 32.16. If the brakes are dragging or worn, or if the rotor needs to be removed from the shaft, remove the two nuts that hold the caliper to the transaxle using a 7/16" wrench. See Figure 32.16.



Figure 32.16

- 32.17. Remove the return spring. The end with the small hook seats into a notch on the brake arm. The end with the large hook goes around a spacer on the lower stud.

Series 1000 and 1500

32.18. Once the caliper is removed from the transaxle, the arm can be unhooked from the spring that connects it to the linkage. See Figure 32.18.

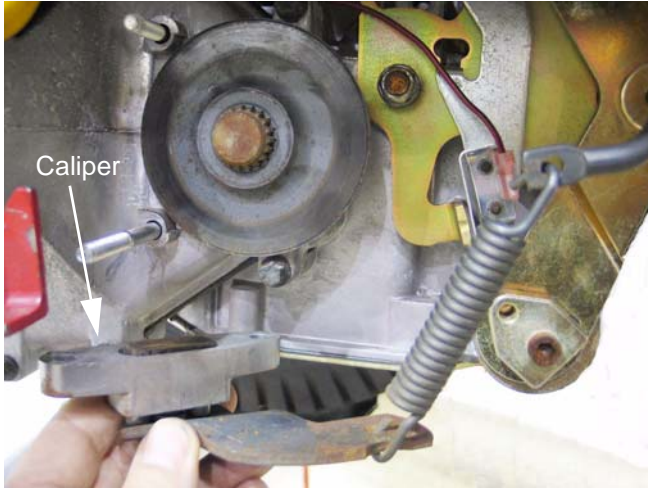

Figure 32.18

32.19. The rotor should slip-off of the splined shaft, providing access to the fixed brake pad. See Figure 32.19.

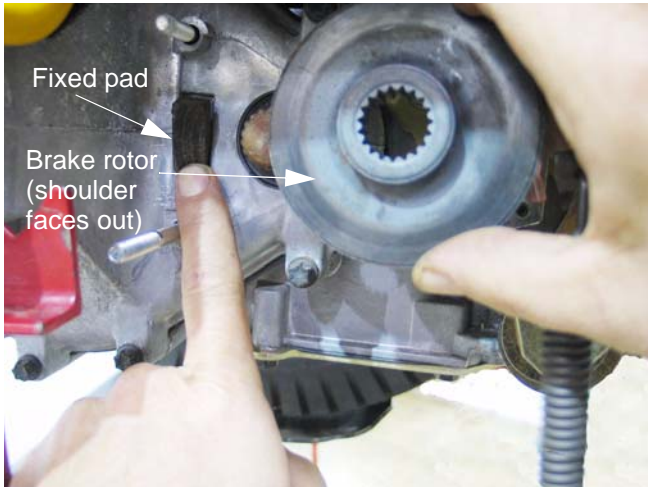

Figure 32.19

32.20. A crease in the brake arm acts as a cam. At rest, the ends of the two pins ride in the peak of the crease: See Figure 32.20.



Figure 32.20

- The brake arm pivots on a square-headed stud.
- The two pins are forced against the backing plate when force is applied to the arm.
- The backing plate rides between the pins and the pad, to prevent the pins from working through the brake pad.

32.21. Replace the pads if they are worn. They frequently last many years unless the brakes have been dragging.

32.22. Be sure the pin bores are clear of dirt and corrosion: either may cause the pins to bind and the brakes to drag.

32.23. On assembly, apply a sparing amount of dry graphite lubricant to the pins and the spots on the brake arm that they contact. Do not allow any lubricant to get on the brake pad.

32.24. Install the brake caliper, tightening the two nuts to 7 to 10 ft.-lbs., then check and adjust the pad-to-rotor clearance. See Figure 32.24.

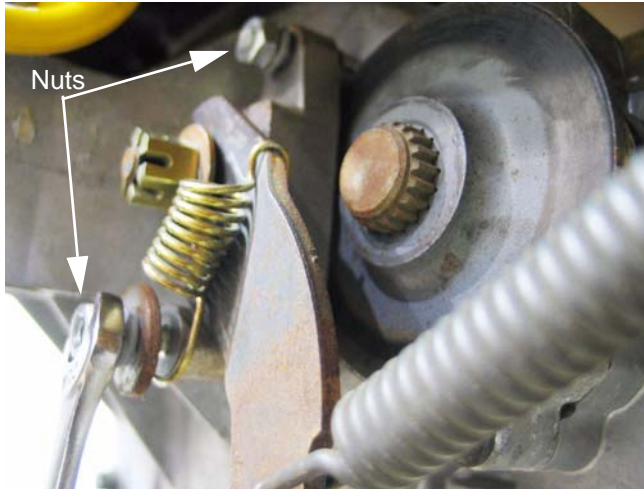

Figure 32.24

- 32.25. Lock the adjustment nut with a new cotter pin.
- 32.26. Install the rear wheel, tightening the lug nuts to a torque of 350 to 500 in.-lbs. Lower the tractor to the ground.
- 32.27. After any brake service is performed, test the brakes as described in steps 24.2 through 24.4, then test-drive the tractor in a safe area that is free of hazards, obstacles, and by-standers before returning the tractor to service.
- 32.28. If there is insufficient travel in the linkage to fully apply the brakes, a simple visual inspection should identify the cause.
- 32.29. Confirm that the brake pedal is firmly attached to the pedal shaft. See Figure 32.29.



Figure 32.29

32.30. Remove the cutting deck to reach the brake pedal shaft, bushings, and bracket.

32.31. Check for excessive play in the bushings. Replace them if they are worn.

32.32. The inboard brake pedal shaft bushing can be removed by removing the cotter pin and washer that secure it. See Figure 32.32.

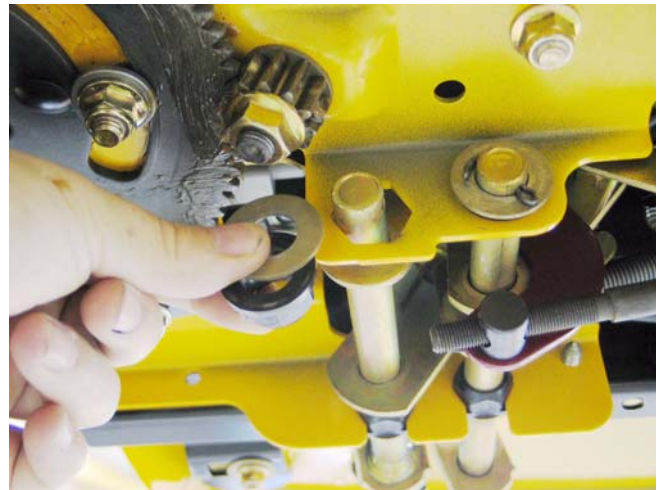

Figure 32.32

32.33. The brake rod must be disconnected to remove the outboard brake pedal shaft bushing. Remove and discard the cotter pin that holds the brake rod to the brake pedal shaft. See Figure 32.33.

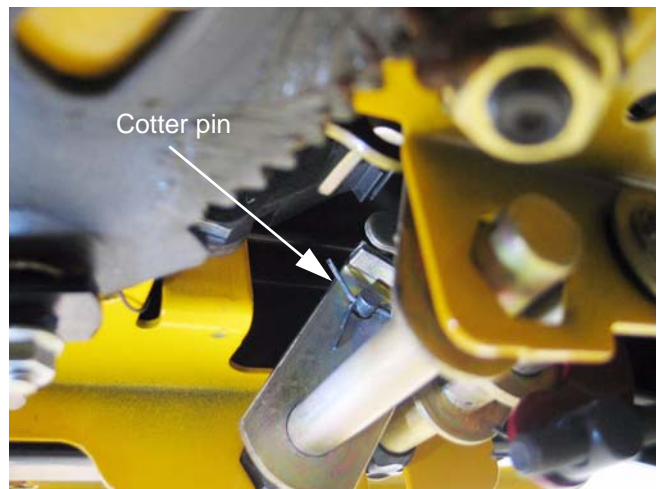

Figure 32.33

Series 1000 and 1500

32.34. Press the brake pedal shaft as far outward as possible, and pry the worn bushing out of the bracket. See Figure 32.34.



Figure 32.34

NOTE: A pair of vice-grips and a plate can be used to press the end of the shaft flush with the edge of the bracket

NOTE: The inner bushing is a hex flange bushing. The outer bushing is similar, but has one open side. The “tooth” in the top facet of the bracket that supports the bushing registers in open side of the bushing.

32.35. Clean any corrosion or dirt from the surfaces where the pedal shaft contacts the the bushing, and slip the new bushings into place.



Figure 32.35

NOTE: Lubrication with grease may accelerate busing wear. If lubrication is applied it should be in dry form such as graphite or PTFE (Teflon).

32.36. Secure the inner bushing with a new cotter pin and the flat washer that was previously removed.

32.37. Move the pedal through it's range of travel to check for bind. If binding is encountered:

- Bind in a portion if the travel may be caused by a bent pedal shaft.
- Constant bind is likely to be caused by a bent bracket.
- Also check for interference between the park brake and cruise control interlocks.

32.38. Correct any binding condition.

32.39. Connect the brake rod to the brake pedal shaft, and secure it with a new cotter pin.

32.40. After any brake service is performed, test the brakes as described in steps 24.2 through 24.4, then test-drive the tractor in a safe area that is free of hazards, obstacles, and by-standers before returning the tractor to service.

33. TRANSAXLE SERVICE AND MAINTENANCE: HYDROSTATIC GT

33.1. In normal use, the transaxle should last the life of the tractor with minimal maintenance.

33.2. Because the transaxle dissipates heat through air-cooling of the housing, it must be kept clean of dirt and debris, and the cooling fan should be replaced immediately if damaged.

33.3. Cleanliness is vitally important when doing any service work that might expose the fluid or internal parts to any form of contamination. Clean thoroughly around any fittings, parts, or seals that are to be removed prior to removal.

33.4. Pressure washing is not recommended, and may contaminate the transmission fluid. Damage caused by contaminated fluid is not warrantable.

33.5. Before commencing internal repairs, eliminate all possible external performance issues:

- Dragging brake
- Maladjusted linkage
- Partially open relief valve
- Slipping traction drive belt/ low engine speed

- 33.6. The transaxle contains .95 gal (116.5 fl.oz) of 20W-50 motor oil with an API classification of SH/CD. See Figure 33.6.

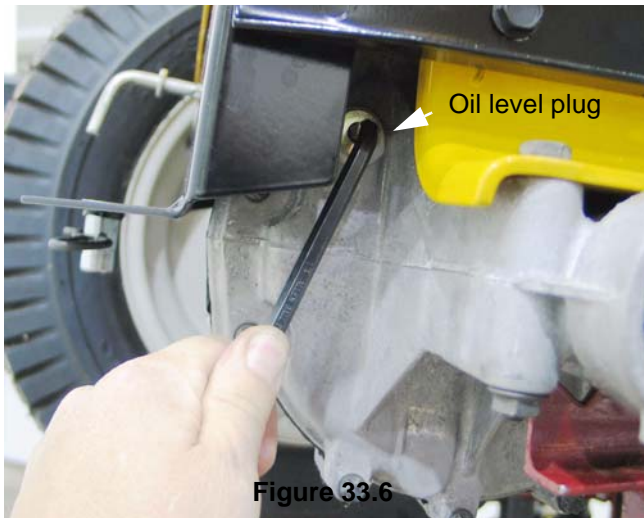

NOTE: Check the fluid level at the fluid level port near the back of the right side axle housing. The plug can be removed with a 1/4" Allen wrench.

NOTE: This oil (fluid) should not have to be changed in the normal service life of the transaxle unless it develops a leak or becomes contaminated.

- 33.7. If the transaxle develops a leak, identify and repair the leak to prevent further damage.
- 33.8. To drain the oil, Hydro-Gear recommends removal of the transaxle, for draining through the fill port.

- **To drain the oil and replace the filter:**

- 33.9. Index-mark the charge pump housing for orientation, then remove it using a 5mm Allen wrench. See Figure 33.9.



Figure 33.9

NOTE: Place a large catch pan under the transaxle.

- 33.10. The charge pump housing will come down with the gerotor pump it contains, an O-ring seal, and 116.5 fl. oz. of 20W50 motor oil.
- 33.11. Remove the 11 perimeter screws that hold the lower cover to the transaxle using a #8 internal Torx bit. See Figure 33.9.
- 33.12. Remove the lower cover and clean all sealant from the mating surfaces.
- 33.13. Remove the charge pump housing screw O-rings from the charge manifold.
- 33.14. Remove the charge check valve spring and ball.
- 33.15. Remove the filter, charge manifold, and the O-ring that seals the charge manifold to the pump center section.
- 33.16. It is highly recommended that the transaxle be reassembled using new O-ring seals and a new filter.
- 33.17. Inspect the gerotor pump. Replace it if it is visibly worn.
- 33.18. Reverse the order of disassembly to reassemble the transaxle:
- Install the O-ring onto the pump center section.
 - Install the filter and charge manifold.
 - Install the charge check ball and spring.

Series 1000 and 1500

- Install the screw O-rings.
 - Install the lower cover without sealant, to align the cover and manifold. Secure it with the 11 perimeter screws.
 - Remove the lower cover, and apply sealant to the mating surfaces where the cover meets the transaxle housing.
 - Install the lower cover, tightening the screws to a torque of 135 to 185 in-lbs.
 - Position a new O-ring seal in the charge pump housing, and place the gerotor in the housing. If one edge of the outside of the gerotor is slightly rounded, it goes into the housing first. The flat edge rides against the lower cover.
 - Position the charge pump, rotating as necessary to align the gerotor pump with its drive shaft and to align the charge pump housing index marks.
 - Install the two socket head cap screws that secure the charge pump, and tighten them to a torque of 87 to 108 in-lbs.
- 33.19. Allow the bottom cover sealant to cure according to the sealant manufacturer's instructions, then fill the transaxle with fluid.
- 33.20. Any time the transaxle fluid has been refilled, it will be necessary to purge the air from the pumps. Air in the drive system will cause:
- Noisy operation
 - Lack or loss of power
 - High operating temperatures
- 33.21. **To purge** the air from the hydraulic system in the transaxle:
- Open the relief valve.
 - Start the engine.
 - Slowly cycle the drive pedal from full speed forward to full speed reverse 5 or 6 times, taking about 10 seconds to complete a single cycle.
 - Stop the engine and check the fluid level at the fluid level port near the back of the right side axle housing. The plug can be removed with a 1/4" Allen wrench. Top-up as necessary.
 - Close the relief valve.
 - Start the engine.
 - Slowly cycle the drive pedal from full speed forward to full speed reverse 5 or 6 times, taking about 10 seconds to complete a single cycle.

- Stop the engine and check the fluid level at the fluid level port near the back of the right side axle housing. The plug can be removed with a 1/4" Allen wrench. Top-up as necessary.
- Repeat as necessary until the transaxle operates normally.

33.22. Refer to Hydro-Gear manual BLN-52359 for complete repair instructions.

34. TRANSAXLE REPLACEMENT: HYDROSTATIC GT

- 34.1. Warrantable failures on Cub Cadet tractors are to be repaired by replacing the transaxle. Failed, warrantable transaxles will be called-back through Cub Cadet's vendor recovery system. Failures of Hydro-Gear transaxles are rare.
- 34.2. Outside of warranty, Hydro-Gear transaxles may be repaired or replaced at the discretion of the customer and servicing dealer.
- 34.3. Before condemning a transaxle, eliminate all possible external performance issues:
- Dragging brake
 - Maladjusted linkage
 - Partially open relief valve
 - Slipping traction drive belt/ low engine speed
- 34.4. Remove the cutting deck to gain access to the linkages that will need to be disconnected.
- 34.5. Lift and safely support the rear of the tractor.
- 34.6. Remove the rear hub caps, then the rear wheels using a 3/4" wrench. See Figure 34.6.



Figure 34.6

- 34.7. Disconnect the front of the brake rod from the brake pedal shaft by removing the cotter pin, and pulling the "L" at the forward end of the rod out of the hole in the brake pedal shaft.
- 34.8. Use the resulting slack in the linkage to disconnect the rear of the brake rod from the spring that joins it to the arm on the caliper. See Figure 34.8.

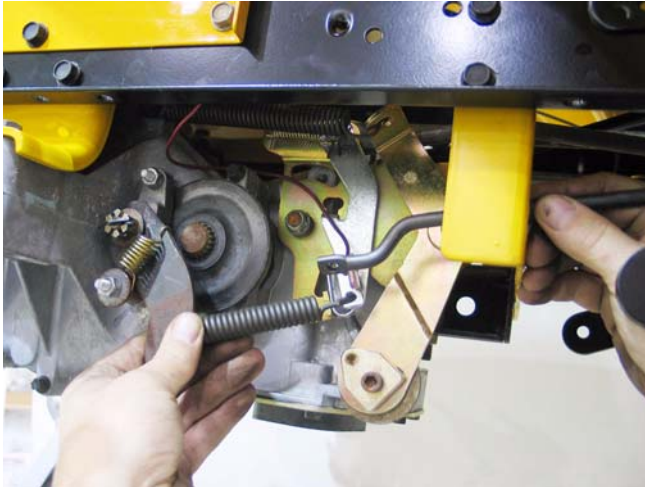

Figure 34.8

- 34.9. Remove the brake rod from the tractor.
- 34.10. Unplug the wire from the reverse safety switch (Red wire w/black trace on Rev-Tek equipped models, Yellow wire w/black trace on others).
- 34.11. Disconnect the ground wire from the transaxle using a 3/8" wrench and a 7/16" wrench. See Figure 34.11.

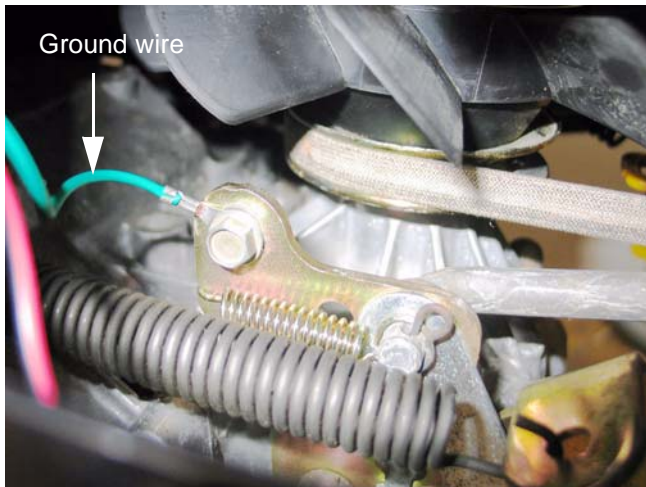

Figure 34.11

- 34.12. Disconnect the control rod from the arm on the hydro.:

- Remove the hairpin clip that secures the rod to the arm, just in front of the connection point for the ground wire.
- Carefully withdraw the rod from the spring and the reverse safety switch lost-motion arm.

- 34.13. Remove the fan from the input pulley on the transaxle using 5/16" wrench. See Figure 34.13.



Figure 34.13

- 34.14. Draw the traction drive belt off of the fixed idler pulley to create slack, then work the belt off of the double idler pulleys, similar to the method described in the "TRACTION DRIVE BELT: HYDROSTATIC GT" section of this manual.
- 34.15. Slip the belt off of the input pulley. See Figure 34.15.



Figure 34.15

Series 1000 and 1500

34.16. Disconnect the hydro relief rod from the relief valve by removing the hairpin clip. Lift the rod off of the arm that controls the valve, and remove the rod from the tractor. See Figure 34.16.

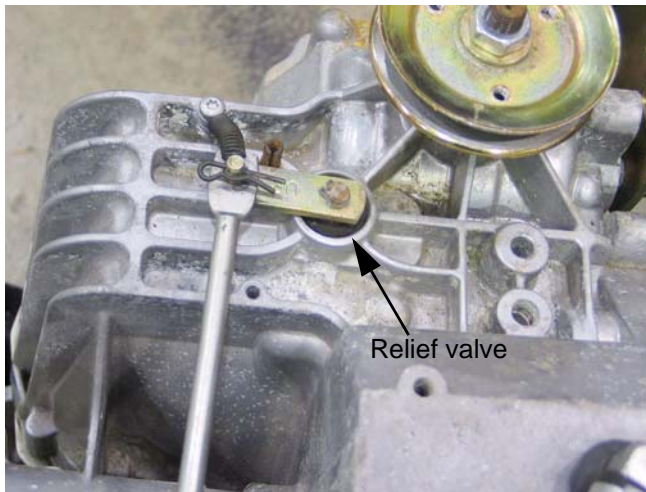

Figure 34.16

34.17. Detach the transaxle vent tube from the left frame channel of the tractor.

34.18. Support the transaxle with a hydraulic jack.

34.19. Remove the two screws that connect the transaxle to the stabilizer bracket using a 9/16" wrench. See Figure 34.19.

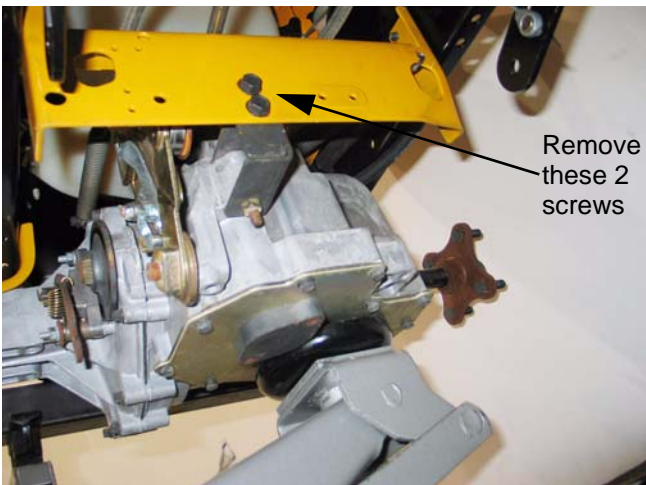

Figure 34.19

34.20. Remove the pair of nuts and bolts that fasten each axle housing of the transaxle to the brackets on the tractor frame. Use a pair of 1/2" wrenches. See Figure 34.20.

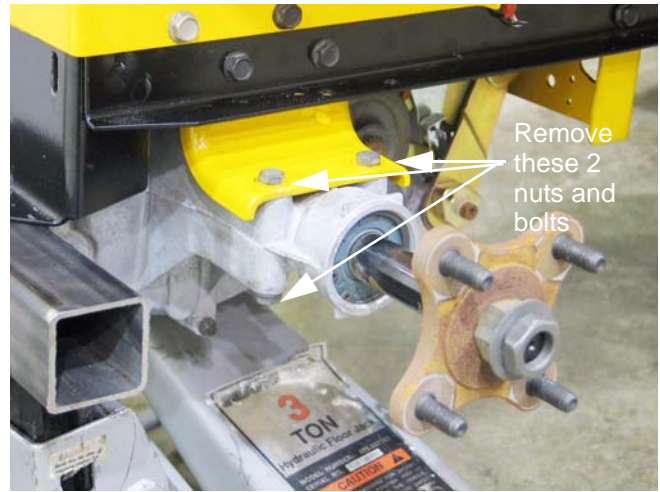

Figure 34.20

34.21. Carefully lower the transaxle to the ground.

34.22. Installation notes are as follows:

34.23. Fill the transaxle with fluid before installing it in the tractor. Some dealers have devised ways to manually drive the input shaft and purge the air from the drive system on the bench, prior to installation.

34.24. If bench purging is not available, follow the purging instructions described in the "TRANSAXLE SERVICE AND MAINTENANCE: HYDRO-STATIC GT" section of this manual after the transaxle is installed.

34.25. Reverse the removal process to install the transaxle.

- Tighten the screws to the torque bracket to a torque of: 35 ft.-lbs.
- Tighten the bolts holding the axle housings to the brackets to a torque of: 250 in.-lbs.
- Tighten the screws holding the fan to the pulley to a torque of: 30-35 in.-lbs.
- Tighten the lug nuts to a torque of:

34.26. Test run the tractor in a safe area that is free of hazards, obstacles, and bystanders to confirm correct operation and adjustment before installing the cutting deck. Make any necessary adjustments.

34.27. Test run the tractor in a safe area that is free of obstacles, hazards, and bystanders after the cutting deck is installed. Check all safety features before returning the tractor to service.

35. STEERING GEAR AND STEERING PINION GEAR REPLACEMENT

NOTE: If you are replacing the steering gear or steering pinion gear, check the condition of both gears for any wear or damage. It may be wise to replace both as a set.

- 35.1. Remove the cutting deck. See cutting deck removal section.
- 35.2. If you are just replacing the steering pinion gear, use a 11/16" socket to remove the flange lock nut securing the steering pinion gear to the steering shaft. See Figure 35.2.

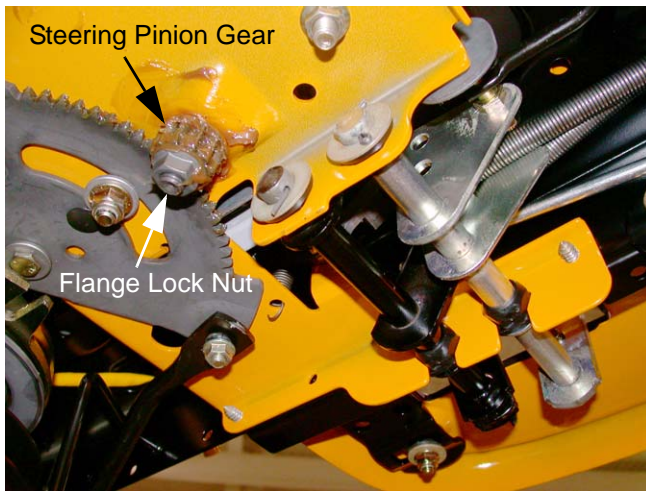

Figure 35.2

NOTE: If you are replacing the steering gear at this time, continue with the following steps, otherwise install a new steering pinion gear and reassemble in the reverse order of disassembly.

- 35.3. If you did not remove the PTO belt guard before you removed the cutting deck, do so now.
- 35.4. Remove the drag links from the steering gear.
- 35.5. Disconnect the PTO electrical connector from the wiring harness.
- 35.6. Using a 5/8" socket and impact wrench, remove the bolt securing the PTO to the engine crankshaft. Remove the PTO from the shaft.
- 35.7. Remove the drive belt from around the twin idler pulleys. This will ease removal of the drive belt from around the engine pulley.

35.8. Lower the engine pulley on the crankshaft as you remove the drive belt from around the pulley. Remove the pulley from the crankshaft. Note the orientation of the pulley for later installation.

35.9. Place a 9/16" wrench on the lock nut that secures the steering gear to the subframe. Using a 14mm socket, remove the hex cap screw and shoulder spacer. See Figure 35.9.



Figure 35.9

NOTE: You may need to use an impact wrench on this cap screw.

35.10. Using a 9/16" wrench and socket, remove the hex cap screw, shoulder spacer and hex nut in the middle of the steering gear. Remove the steering gear. See Figure 35.10.



Figure 35.10

35.11. Install in the reverse order of disassembly.

Series 1000 and 1500

36. STEERING ADJUSTMENT / ALIGNMENT

IMPORTANT: The front tires will have a “TOE-IN” between $1/16$ ” and $5/16$ ” to allow the unit to track properly.

- 36.1. Check the tire pressure in the front tires and make certain that they are at approximately 14 PSI.
- 36.2. Place the unit on level ground.
- 36.3. Place the steering wheel in the straight forward position.
- 36.4. Lower the deck lift lever to the lowest position.
- 36.5. Line up the centering hole in the steering gear with the centering hole in the support plate, and insert a $1/4$ ” Phillips screw driver up through both. See Figure 36.5.



Figure 36.5

- 36.6. In front of the axle, measure the distance horizontally from the inside of the left rim to the inside of the right rim. See Figure 36.6.



Figure 36.6

- 36.7. From behind the axle, measure the distance horizontally from the inside of the left rim to the inside of the right rim.
- 36.8. The measurement taken in front of the axle should be between $1/16$ ” and $5/16$ ” less than the measurement taken behind the axle. If not, perform the following steps:
- 36.9. Loosen the jam nut at the rear of the right ball joint that secures the ball joint to the drag link using a $1/2$ ” wrench and an $11/16$ ” wrench. See Figure 36.9.

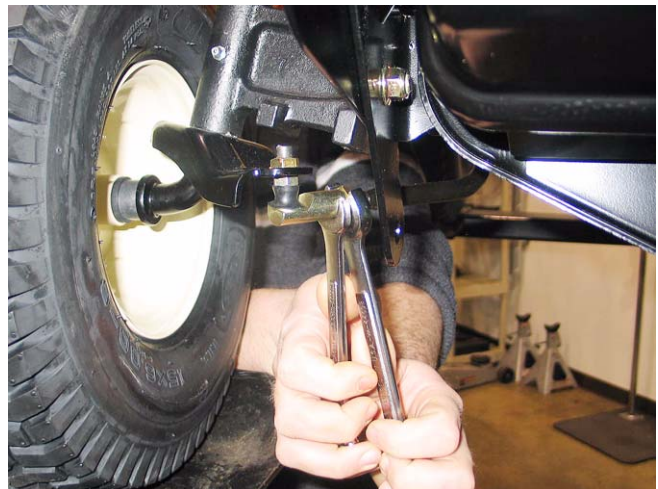

Figure 36.9

- 36.10. Remove the hex nut and lock washer that secures the right ball joint to the right axle assembly using a $1/2$ ” wrench and a $9/16$ ” wrench.

- 36.11. Remove the right hand ball joint from the right hand drag link. See Figure 36.11.



Figure 36.11

- 36.12. Remove the left hand ball joint performing steps 9, 10 and 11 above.
- 36.13. Place the left and right tire assemblies in the straight forward position.
- 36.14. Set the toe-in for the rim assemblies to the straight forward position.
- 36.15. Thread the right hand ball joint onto the right hand drag link until the mounting hole in the right hand axle assembly lines up with the ball joint.
- NOTE:** Count the number of turns the ball joint was rotated onto the drag link. This number should be equal for the left side as well.
- 36.16. Secure the right hand ball joint to the right hand axle assembly with the lock washer and nut removed earlier, using a 1/2" wrench and a 9/16" socket
- 36.17. Secure the right hand ball joint jam nut to the right hand drag link using a 1/2" wrench and an 11/16" wrench.
- 36.18. Install the left hand ball joint using steps 15, 16 and 17.

NOTE: Make certain the same amount of rotations are used on the left ball joint as the right ball joint.

37. PIVOT BAR SERVICE

NOTE: On newer units with a one piece hood see section 2 on hood removal, remove the front bumper and skip to section 36.8

- 37.1. Loosen the plastic wing nuts securing the side panels to the battery hold down bracket and the grille assembly. See Figure 37.1.

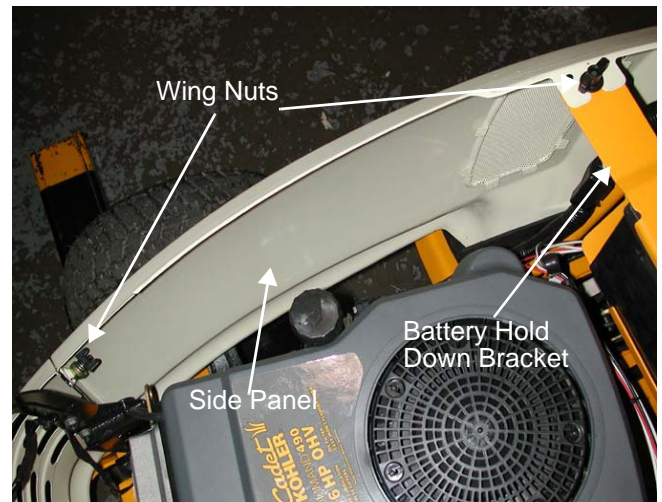

Figure 37.1

- 37.2. Remove the side panels from the tractor.
- 37.3. Remove the hairpins, flat washers and clevis pins (or screws) securing the front bumper to the tractor frame. See Figure 37.3.

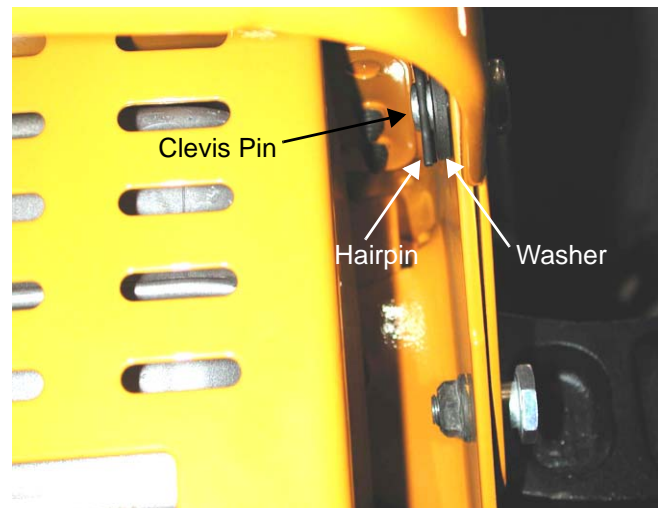

Figure 37.3

- 37.4. Remove the front bumper.

Series 1000 and 1500

37.5. Disconnect the wiring harness connector from the lighting harness connector. See Figure 37.5.

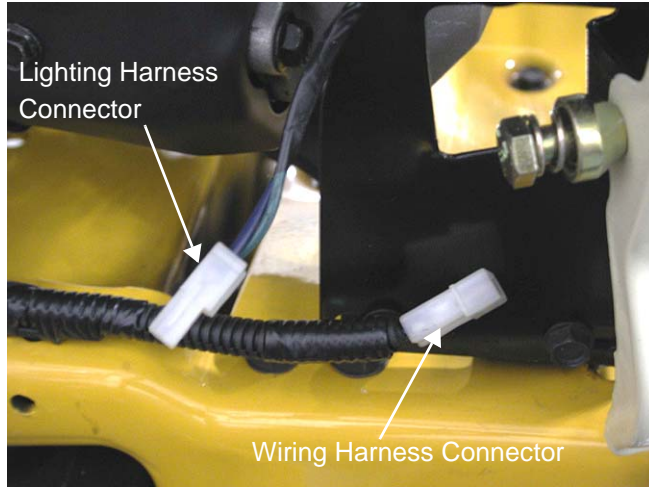

Figure 37.5

37.6. Remove the hex bolts securing the front grille assembly to the front frame assembly using a 1/2" socket and extension. See Figure 37.6.

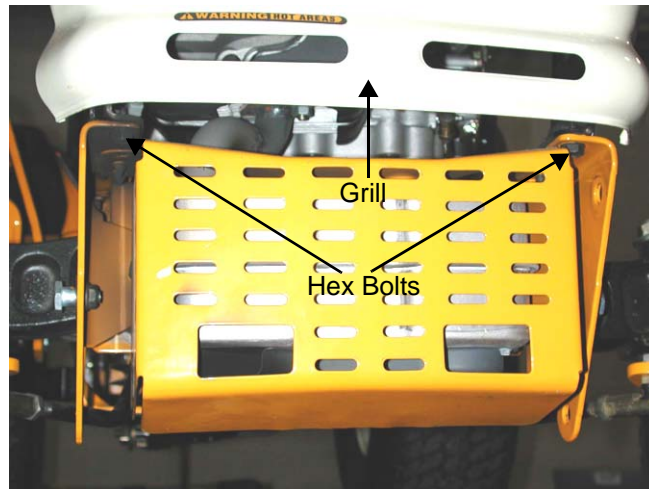

Figure 37.6

37.7. Remove the grille and hood assembly together.

37.8. Remove the muffler and muffler guard as one unit.

37.9. Secure the front of the tractor off of the ground, behind the pivot bar.

37.10. Loosen the large hex flange nut securing the left axle assembly to the pivot bar using a 15/16" socket. See Figure 37.10.

NOTE: Some models will have a push cap. In that case you would remove the push cap and discard it. Do not reuse push caps.

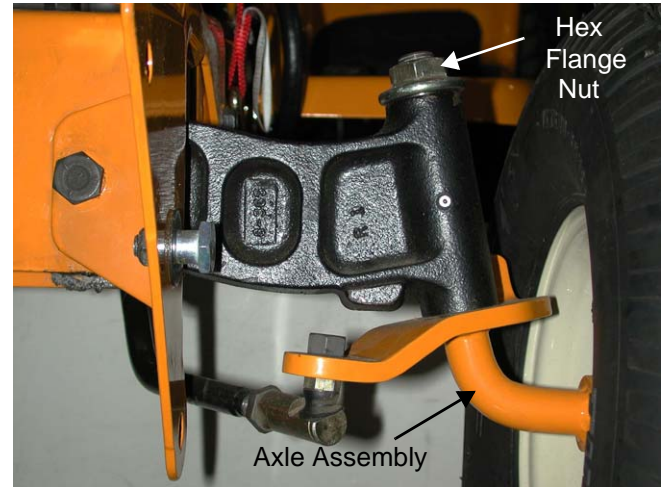

Figure 37.10

37.11. Remove the lock nut securing the left ball joint to the left axle assembly using a 9/16" socket and a 1/2" wrench.

37.12. Loosen the large hex flange nut or remove the push cap securing the right axle assembly to the pivot bar using a 15/16" socket. See Figure 37.12.

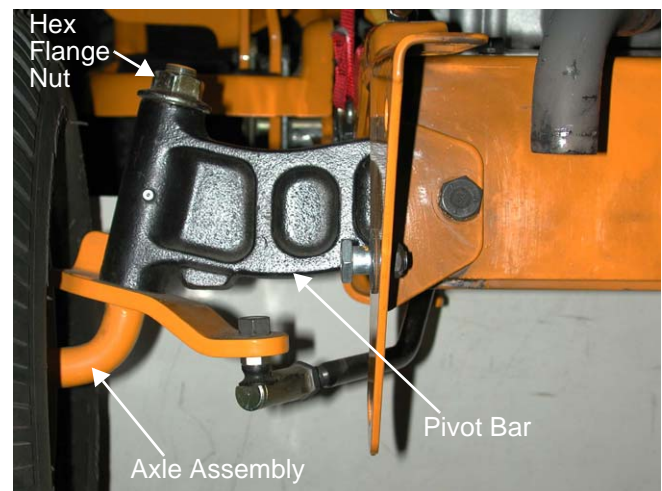

Figure 37.12

37.13. Remove the lock nut securing the right ball joint to the right axle assembly using a 9/16" socket and a 1/2" wrench.

- 37.14. Remove the large hex flange nuts securing the axles to the pivot bar.
- 37.15. Remove the front axles and tire assemblies from the pivot bar.
- 37.16. Remove the pivot bar stop bolts and hex nuts using a 3/4" socket and a 9/16" wrench.
NOTE: On units with the J-bolt style deck stabilizer rod, the mounting plate will come off with the pivot bar stop bolts.
- 37.17. Squeeze in on the wiring harness locking tab at the right muffler bracket and release the wiring harness using needle nose pliers.
- 37.18. Remove the hex screws securing the left and right muffler support brackets to the frame using a 1/2" socket. See Figure 37.18.

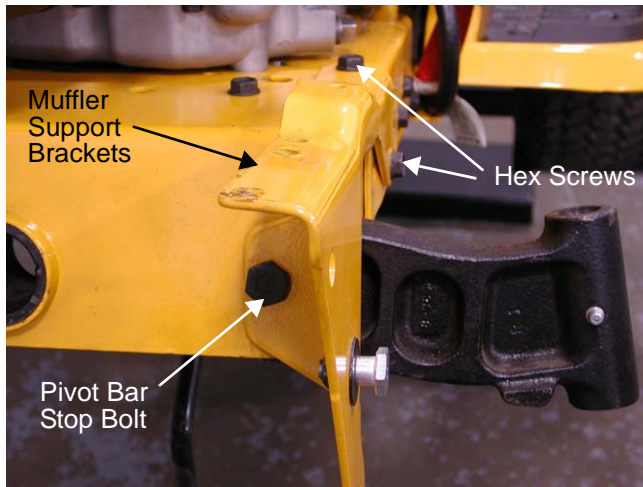

Figure 37.18

- 37.19. Remove the left and right muffler support brackets.
CAUTION: On newer production units the muffler support brackets cover the front pivot axle bracket. when you remove the muffler support brackets take care to prevent the pivot axle from falling off.
NOTE: The brackets are marked for correct installation.

- 37.20. Remove both self tapping screws securing the front pivot axle bracket to the frame using a 1/2" socket. See Figure 37.20.

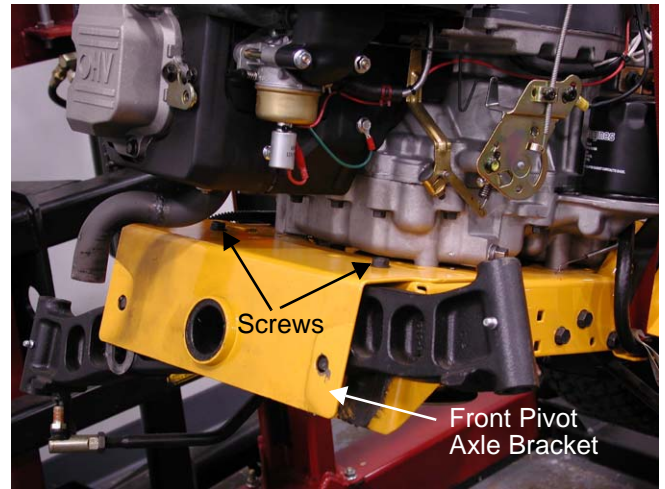

Figure 37.20

- 37.21. Remove the front pivot axle bracket.
- 37.22. Reassemble in reverse order.

38. ELECTRICAL SYSTEM

- 38.1. **Introduction:** The electrical system for the 1000 and 1500 series tractors can be classified into three categories:

- RMC
- Pre-RMC

- 38.2. The **RMC module contains electronic logic circuits.** When diagnosing anything that is connected to the RMC module, high impedance test light or a high impedance digital volt-ohm meter (DVOM) should be used. The amperage draw of a standard incandescent test light may over-burden some internal electronic circuits, burning-out the module.

NOTE: These tools are not outrageously expensive or exotic. High impedance test lights (Thexton model 125 is typical) can be purchased locally from stores like NAPA for under \$30.00. Appropriate multi meters can be purchased for under \$100.00, and are an invaluable tool for any competent technician.

- It is typical when industries **shift from electro-mechanical to electronic controls** that diagnosis shifts from tracing through a number of independent circuits to checking the in-inputs to and out-puts from a central processor. This is similar

Series 1000 and 1500

to, but much less complex than the transition that the auto industry made with the conversion to fuel injection in the 1980s.

- The **starter safety circuit** has no connection to the RMC module.
- The **safety circuits that are capable of turning-off the engine** work through the RMC module.
- It is still important to be familiar with the workings of the individual components of the electrical system, but **some of them can now be checked from a central point on the tractor**. This makes life easier on the technician, frequently making it unnecessary to connect to difficult to reach switches in the preliminary stages of diagnosis.
- The function of individual safety switches can be seen as providing information “inputs” to the RMC module.
- The next part of this section gives a **detailed description of the electrical components** on this tractor, their function in the system, and their physical location on the tractor. Armed with this information and the proper tools, a technician should be able to efficiently diagnose most electrical problems.

NOTE: The test procedures for the normal mode in the RMC system are the same as the Pre-RMC system and will not be called out separately in this manual.

- 38.3. The **Key Switch** is similar to those used in a variety of MTD applications since 1999. The difference in this case is that it is incorporated in the same housing as the RMC module; the two items are not available separately. See Figure 38.3.

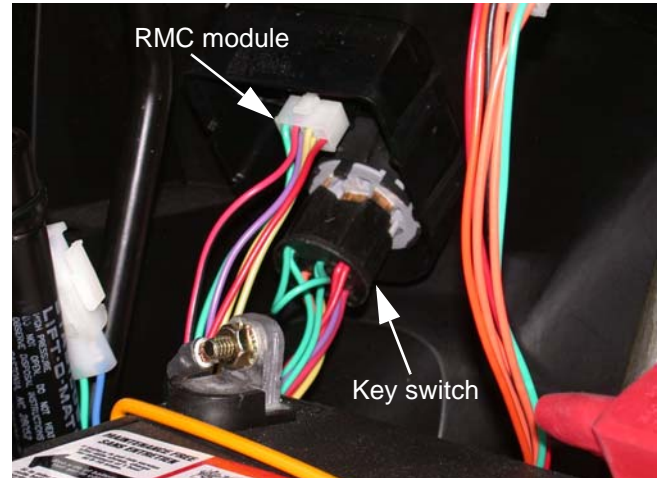

Figure 38.3

- 38.4. In the **OFF** position, continuity can be found between the M, G, and A1 terminals. See Figure 38.4.

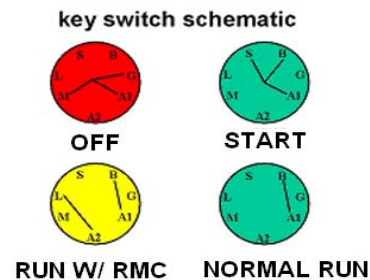

Figure 38.4

- M is connected to the magneto by a yellow wire, G is connected to ground by a green wire, and A1 is connected to the after fire solenoid and alternator.
- In the **OFF** position, the magneto primary windings are grounded, disabling the ignition system. The alternator output that normally keeps the after fire solenoid powered-up is given a more direct path to ground, depriving the after fire solenoid of power. This turns-off the fuel supply.

- **Symptom-engine runs with key in OFF position:** The key switch is not completing the path to ground either because of an internal fault or a bad ground connection elsewhere in the harness. Check continuity between M, G, and A1 terminals with key switch in OFF position. Check green wire continuity to ground.
 - **Symptom-loud "BANG" when key is turned to the OFF position:** The after-fire solenoid is not closing, either because it is physically damaged or the alternator output is not getting grounded. Check for power at the solenoid. Check continuity between G and A1 terminals. Check continuity from red wire to afterlife solenoid.
 - **Symptom-Engine runs 3-5 seconds after key is turned to OFF position:** The after-fire solenoid is turning-off the fuel supply, but the ignition is continuing to operate. Check continuity between the M and G terminals in the OFF position. Check continuity from yellow wire connection all the way to the spade terminal on the magneto.
- 38.5. In the **START** position, continuity can be found between B, S, and A1 terminals.
- Battery power from the B terminal is directed to the start circuit through the S terminal and to the afterlife solenoid through A1. There is no alternator output to A1 until the engine is running.
 - **Symptom-No crank and no starter solenoid click:** Power is not getting to the trigger spade on the starter solenoid. Test for a good battery then check for power where the fused red wire with white trace connects to the B terminal. Check for continuity between B and S terminals in START position. If power is getting to the S terminal in the START position, the problem lies down-stream in the starter circuit; Check continuity from the orange wire on the S terminal to the orange wire with white trace on the trigger spade on the starter solenoid. If it is broken, trace through the brake and PTO switches.
 - **Symptom-No crank, solenoid click:** The problem lies in the heavy-gauge side of the starter circuit; battery cables, starter cable, solenoid, or ground issue.
 - **Symptom-Crank, spark, but not fuel:** First test for power at the solenoid, if no power the check for continuity from B to A1 in the START position. If power is reaching the red wire that connects to the A1 terminal in the start position, the problem lies down-stream of the key switch. A handy quick-check is to apply power to the red wires where they connect to the S terminal (whole circuit) or directly to the afterlife solenoid to listen for the audible "click" that it makes when functioning.
- **Symptom-Crank, but no spark:** This is a highly unlikely scenario. If it occurs after a key switch has been changed independently of the RMC module, this would arouse suspicion that the wrong key switch was installed. Otherwise, the problem lies elsewhere in the safety circuits or engine. Do not over-look the possibility of a bad magneto or chafed ground lead within the engine harness.
- 38.6. In the **NORMAL RUN** position (green zone), the B and A1 terminals should have continuity. Once the engine is running, the alternator produces current that tracks-back from the A1 circuit to charge the battery, via the red wire with white trace connected to the B terminal. The plain red wire carrying alternator current to the A1 terminal doubles-back, with the second plain red wire on that terminal supplying power directly to the after fire solenoid.
- **Symptom-Battery does not charge:** If the switch has continuity between B and A1 in the RUN position, follow the engine manufacturer's recommendations for testing alternator output. If alternator output is getting to and through the key switch, but not reaching the battery, the fuse may have blown after start-up. A blown fuse will disable the starter circuit. A simple quick-test for the presence of alternator output at the battery is to check across the battery posts for DC voltage.
 - **Symptom-After fire solenoid does not work: engine starts and dies:** The after fire solenoid is powered directly by the red wire carrying alternator output, and should operate independently of anything else on the tractor once the engine is running. If the alternator fails *and* battery power is not reaching the afterlife solenoid through the key switch, it will not work. This is an unusual set of circumstances.
- 38.7. In the **REVERSE CAUTION MODE** (yellow zone), the same characteristics are true as for the normal run position, but *in addition* the L terminal will have continuity with the A2 terminal. The A2 terminal is connected to the RMC module by a white wire. The L terminal (formerly used for the lighting circuit) connects directly to the ground circuit of green wires. When the key is in the REVERSE CAUTION

Series 1000 and 1500

MODE position, the white wire carries a ground signal to the RMC module. When the parking brake is not set, this ground signal tells arms (enables), *but does not turn-on* the RMC module.

- **Symptom-RMC module will not turn-on:** Check for continuity between A2 and L terminals on the key switch when it is in the REVERSE CAUTION MODE position. Confirm that the green wire has continuity to ground. If the switch is capable of establishing a ground signal to the RMC module, the problem is likely to lie elsewhere in the system.
- **Symptom-RMC module will not turn-on:** confirm that the ground path (continuity to ground) to the white wire is broken when the key switch is in any position other than REVERSE CAUTION MODE. The RMC module is disarmed (disabled) when the parking brake is set. To re-arm the module, the key is moved to another position, breaking the ground signal, then returned to the REVERSE CAUTION MODE, re-establishing the ground signal. It works something like a latched relay. If it is not possible to break the ground-path, it is not possible to freshly establish it either, and the RMC module will not be arm-able. Causes for such a condition might include a shorted or incorrect key switch, or a chafed white wire shorting to ground between the key switch and the RMC module.

38.8. The RMC Module is in the same housing as the key switch, and is not available separately. For the purpose of diagnosis it is treated separately. Diagnosis in unit with the key switch introduces too many over-lapping variables. See Figure 38.8.

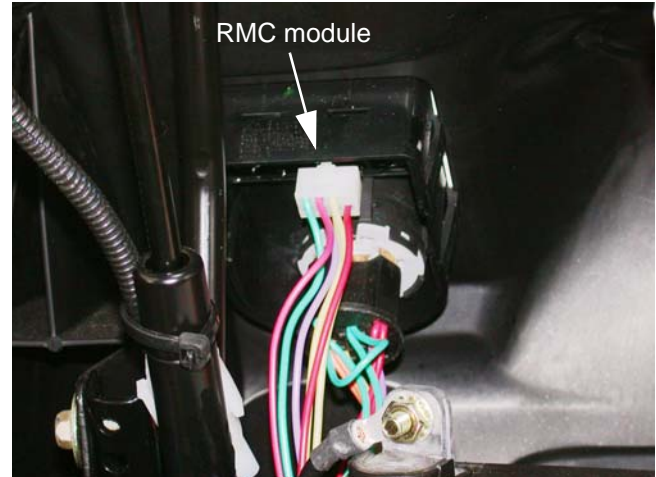

Figure 38.8

38.9. **Principle:** To diagnose the module, the simplest approach is to check all of the inputs (safety circuits) that are connected to it. If the inputs work properly, but the RMC module does not work properly (outputs), then the module can be determined to be faulty. A specific procedure is covered, following the description of the correct operation of the RMC module.

38.10. **Working properly:** The module cannot be diagnosed if its function is not understood. It is designed to work as follows: See Figure 38.10.



Figure 38.10

- When the **RMC module is disarmed**, the tractor will operate as MTD tractors have historically operated:
If reverse is engaged when the electric PTO is ON, the PTO clutch will turn-off.
If the operator leaves the seat with the engine running, the engine will turn-off.
If the operator leaves the seat with the PTO in the OFF position, the engine will turn-off unless the brake is applied.
When the RMC module is armed, the tractor will operate identically to when the module is disarmed.
- When the **RMC module is armed and turned-on**: The tractor will operate identically to when the module is disarmed, except that the operator will be able to put the transmission in reverse with the PTO engaged and the cutting deck will continue to run. The operator may put the tractor into and out of reverse as many times as they wish without having to re-arm or turn-on the module again.
- **To arm the RMC module**: the operator must turn the key switch to the REVERSE CAUTION MODE (yellow zone), with the parking brake released.
- **To turn the RMC module ON**: The module must first be armed, then the orange triangular button is depressed, illuminating the red LED indicator to indicate that it is ON. It is important that the operator must take two actions to turn the RMC module ON so that they do not do so inadvertently.
- **The RMC module will turn-OFF and disarm if**:
The operator moves the key to any position other than REVERSE CAUTION MODE.
The operator sets the parking brake.
If the operator leaves the seat without setting the parking brake, the engine will turn-off. The key movement necessary to re-start the engine will make it necessary to re-arm and turn-on the RMC module if the operator wishes to continue with the ability put the tractor in reverse while the PTO is running.
- **To re-arm and turn the module ON**: If the key is in REVERSE CAUTION MODE position, it must be turned to another position (Normal Run), then returned to REVERSE CAUTION MODE. Once re-armed, the module can be turned-on by pressing orange triangular button. It will be confirmed that the module is ON by the illumination of the red LED on the module.

38.11. **To identify a faulty RMC module**: If the RMC module does not function as described, the **RMC plug test** should be the first step in diagnosis.

- If the RMC plug test confirms that the safety circuits (inputs) work as designed, yet the RMC module does not work properly, the RMC module is faulty.
- The RMC plug test will give an indication of what the problem is if it is not a faulty RMC module. If the problem is identified in a particular circuit, check the safety switch that is associated with that circuit. If the switch is good, then the problem lies within the wiring harness.

NOTE: Like the electronic components found on most cars, the RMC module requires a fully charged battery to work properly. If the system voltage falls below 12 V, an accurate diagnosis of the RMC module is impossible because the module will be temporarily disabled by low voltage.

38.12. Disconnect the molded 8-pin plug from the RMC module. See Figure 38.12.

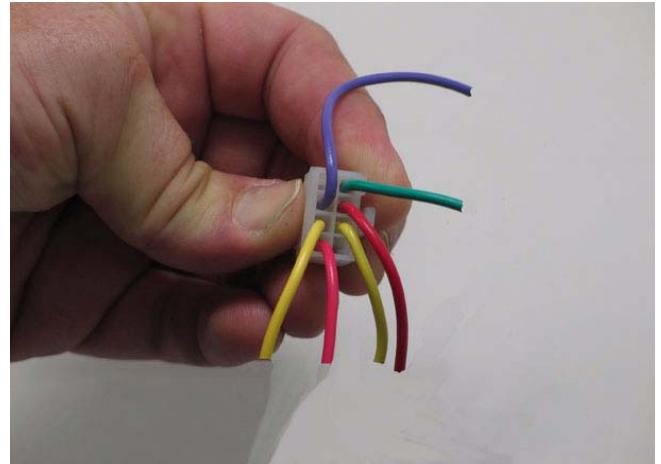

Figure 38.12

NOTE: For the 1000 series it may be necessary to unfasten the fuel tank and move it aside for easier access to the plug. For the 1500 series you may need to move the battery to get at the plug.

Series 1000 and 1500

38.13. Looking at the plug head-on, it will be configured as shown in the diagram: There will be 8 female pin terminals. When probed they should yield the results described in the following sections. See Figure 38.13.

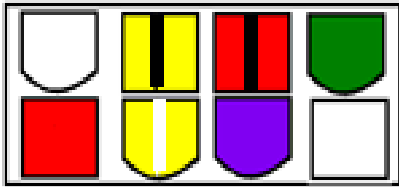

Figure 38.13

NOTE: You will see a difference in the configuration of the adaptor of the manual PTO vs. the Electric PTO.

38.14. Top left middle □-shape: Yellow wire with Black trace:

- **Behavior:** Should show DC power with the key on.
- **Circuitry:** The yellow wire with black leads directly to the PTO switch.

38.15. Check the PTO and seat safety circuits with the 8-pin pigtail connector unplugged, then reconnect it and continue with the RMC plug test.

- **Behavior:** When the female pin terminal leading into the main harness is probed (yellow wire), there should be continuity to ground *only* when the seat is empty.
- **Circuitry:** The yellow wire with white trace leads to the forward terminal on the seat safety switch, where it finds a path to ground when the seat is empty.
- **Interpretation:** If behavior is correct, the seat safety circuit is good. If there is continuity to ground when the seat is occupied, the switch may be inoperative, or there may be a short to ground in the wire leading to it. If there is not continuity to ground when

the seat is empty, the switch may be inoperative or there may be an open condition in the wire leading to it.

- **Circuitry:** The yellow wire with black trace leads to the PTO switch, where it finds a path to ground when the PTO is ON.
- **Interpretation:** If behavior is correct, the N.C. side of the PTO switch /circuit is functioning properly. If there is continuity to ground when the PTO is OFF, the switch may be inoperative or there may be a short to ground in the wire leading to it. If there is not continuity to ground when the PTO switch is ON, the PTO switch may be inoperative, or there may be an open condition in the wire that leads to it.

38.16. There is a red wire with black trace between yellow wire with a black trace and the green wire. This wire provides the module with input from the **reverse switch**.

- **Behavior:** When the tractor is in reverse, this terminal should have continuity to ground.
- **Circuitry:** This wire runs directly to the reverse safety switch on the transmission support for the CVT tractors or at the brake caliper on the hydros. This is a simple metal tang switch that grounds-out against the transmission control lever.
- **Interpretation:** Continuity to ground when the tractor is not in reverse would indicate a short to ground north circuit. This could take the form of a chafed wire contacting ground, a bent reverse safety switch that is always in contact with another metal part, or a broken plastic insulator that separates the switch from the fender. Lack of continuity to ground would indicate a broken or disconnected wire leading to the reverse safety switch, or a switch that is not closing because of physical damage or corrosion.

38.17. At the opposite end of the top row from the yellow wire with black trace is a green wire.

- **Behavior:** The green wire should always have continuity to **ground**.
- **Circuitry:** The green wire leads to ground.
- **Interpretation:** If this ground path is not good, there will probably be other ground-related issues with the tractor: slow starter motor, slow battery charge, dim lights. All ground connections should be mechanically secure and corrosion free.

38.18. The red wire on the OCR plug carries **battery voltage**.

- **Behavior:** D.C. battery voltage should show-up on a volt meter when the red probe is touched to this terminal and the black probe is grounded, regardless of the key switch position.
- **Circuitry:** This wire draws power directly from the B terminal on the key switch.
- **Interpretation:** If there is not battery voltage at this terminal, the tractor is probably not function at all. Look for a blown fuse, disconnected battery, disconnected ammeter or some other major fault.

38.19. The purple wire provides a **ground signal** to the RMC module when the key switch is placed in the **REVERSE CAUTION MODE**.

- **Behavior:** There should be continuity to ground at this terminal when the key switch is in the REVERSE CAUTION MODE position.
- **Circuitry:** When the key switch is in the REVERSE CAUTION MODE position, a ground path is established by connecting terminal A2 to terminal L within the key switch. The white wire from the RMC module connects to A2, and a green ground wire connects to L.
- **Interpretation:** If the purple wire fails to reach a ground path when the key switch is in the REVERSE CAUTION MODE position, the RMC module will not arm or operate. Check the key switch for continuity between A2 and L in the REVERSE CAUTION MODE position, confirm that the green wire connecting to the L terminal does have good continuity to ground, and check for any loss of continuity in the purple wire that extends from the key switch to the RMC module, including the molded connector between the two components.
- If the RMC plug test indicates fault with any of the safety switches, the next step is to test the suspect switch. The operation of those switches is described in the following sections.

39. UNDERSTANDING THE PTO SWITCH

39.1. A-COM is in the starter inhibit circuit. It is a normally closed (NC) set of contacts. When the PTO is OFF, and the contacts are closed, power coming from the brake switch (key switch in START, brakes ON) through the orange wire with black trace is passed on to the trigger terminal on the starter solenoid through the orange wire with white trace.

39.2. B-COM is in the safety shut-down circuit. It is a normally opened (NO) set of contacts. A circuit is completed from the M terminal on the key switch through the yellow wire to the Magneto terminal on the RMC module through the yellow wire with black trace when the contacts are closed. This gives the RMC module the ability to turn-off the engine when the PTO is ON.

39.3. In C-Com, power is supplied to the PTO switch from the A1 terminal of the ignition switch through a red wire. when the PTO switch is turned on this completes the circuit to allow power to go to the PTO clutch. It is a normally opened (NO) set of contacts.

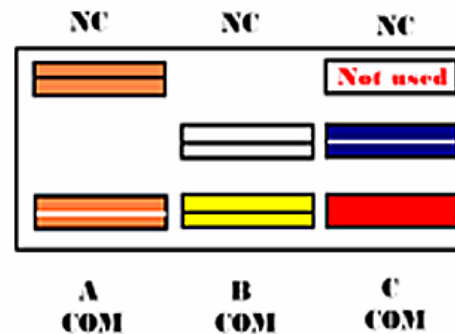

Figure 39.3

NOTE: The top terminals are showing normally closed at rest and the middle terminals are normally open at rest

NOTE: There are three contacts on the right side in the C-COM. For this application the normally opened (NO) contact is used.

Series 1000 and 1500

39.4. The **Brake Switch** is mounted to the inside of the frame slightly right of the steering shaft. See Figure 39.4.

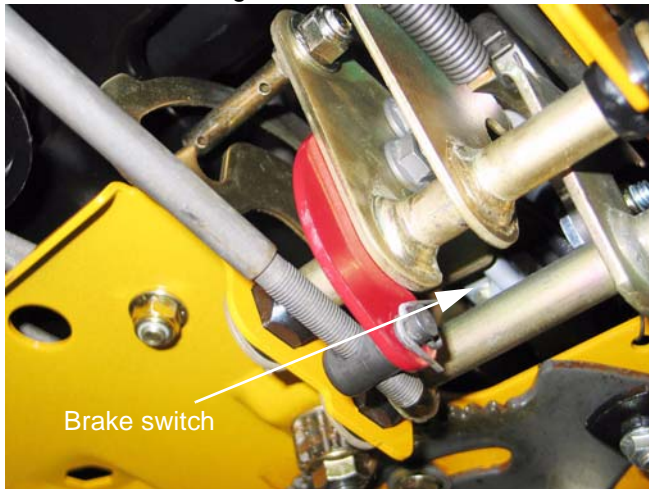

Figure 39.4

- The plunger on the switch is depressed when the clutch / brake pedal is pressed-down, de-clutching the drive belt and applying the brakes. The switch contains two sets of contacts.
- A normally open (NO) set of contacts is in the starter inhibit circuit. When the clutch / brake pedal is depressed, the contacts are closed, power coming from the key switch in START) through the orange wire is passed on to the PTO switch through the orange wire with black trace.
- A normally closed (NC) set of contacts is in the safety shut-down circuit. A circuit is completed from the M terminal on the key switch, and directly from the magneto primary windings through the pair of yellow wires to the clutch / brake switch through to the yellow wire with black trace when the contacts are closed.
- The yellow wire with black trace leads to one element of the seat switch. If the seat is vacant *and* the pedal is up, the engine will turn-off.

39.5. The **Reverse Safety Switch** is a simple metal contact tang. The gear selector touches it when placed in the reverse position, providing a ground path through the gear sector lever itself. See Figure 39.5.

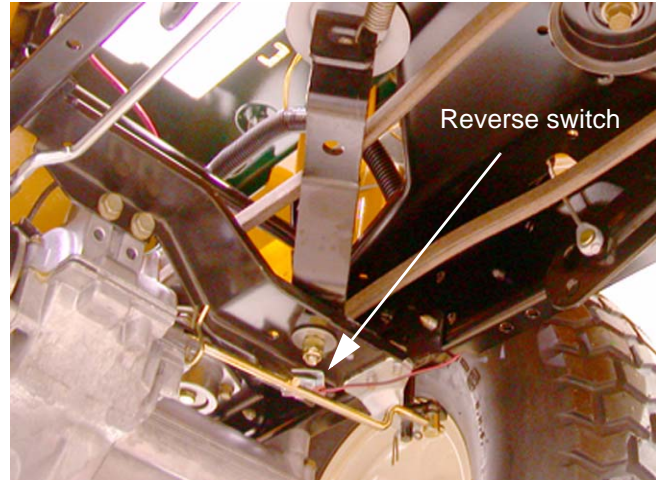

Figure 39.5

39.6. On hydraulic drive units the reverse safety switch is located on the right side just above the brake arm. See Figure 39.6.

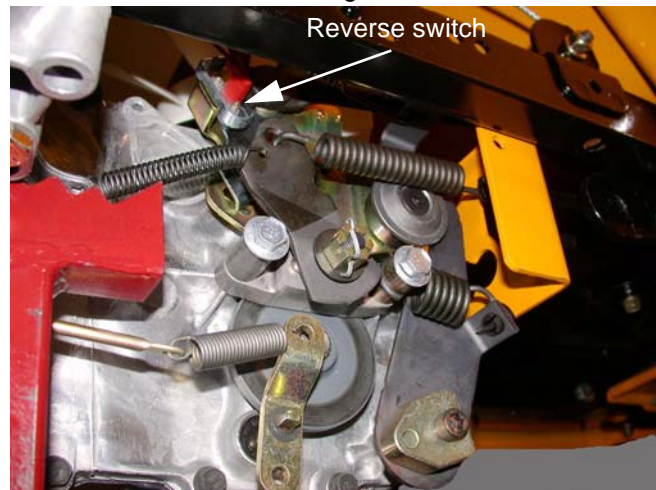

Figure 39.6

39.7. The **Seat Safety Switch** consists of a pair of simple metal contact tangs attached to the seat mounting bracket. See Figure 39.7.

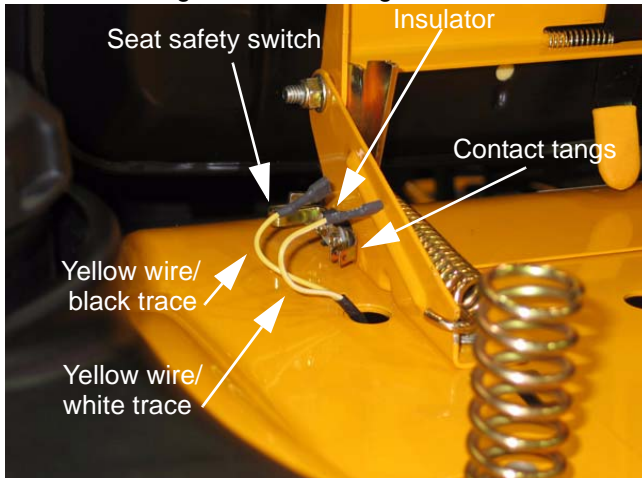

Figure 39.7

- The yellow wire with white trace is connected to the front spade terminal on the seat safety switch. When the seat is vacant, the tab on the seat bracket closes a ground path in series with the PTO switch. If the PTO is ON and the seat is empty, the circuit is completed, shorting-out the primary windings of the magneto, turning-off the engine.
- The yellow wire with black trace is connected to the rear spade terminal on the seat safety switch. When the seat is vacant, the tab on the seat bracket closes a ground path in series with the brake switch. If the brake is not applied, and the seat is empty, the circuit is completed, shorting-out the primary windings of the magneto, turning-off the engine.
- The most common problems are likely to be caused by physical damage: a broken insulator between the switch and the seat bracket, an unplugged wire, or a bent tang.

39.8. On the 1000 series tractors the **starter solenoid** is mounted at the left rear corner of the frame. The mounting bracket is visible beneath the left fender, and the solenoid itself is accessibly by removing the battery. See Figure 39.8.

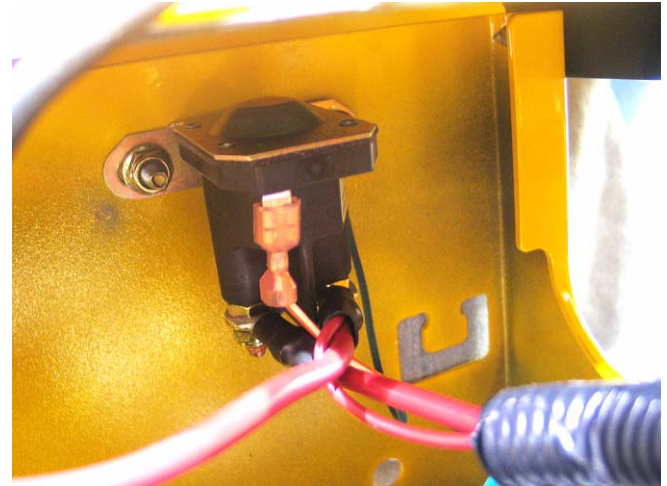

Figure 39.8

- When the proper safety conditions are met, (brake applied, PTO OFF) the orange wire with white trace energizes the windings that magnetize an iron core, pulling the contacts closed between the two heavy posts, connecting battery power to the starter motor.

39.9. The 1500 series tractors use a starter solenoid that is actually part of the starter.

39.10. The starters on the Kohler Command engines have the starter solenoid on the starter. See Figure 39.10.

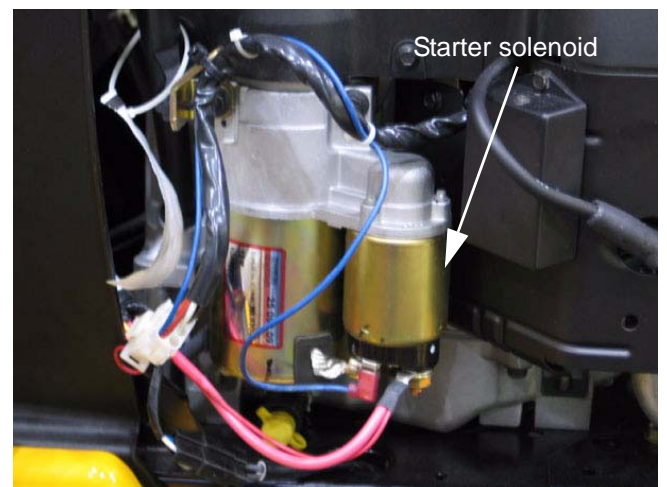

Figure 39.10

Series 1000 and 1500

39.11. The **lighting circuit** is hot whenever the engine is running. It does not draw from the battery, but runs directly off its own circuit on the alternator. See Figure 39.11.

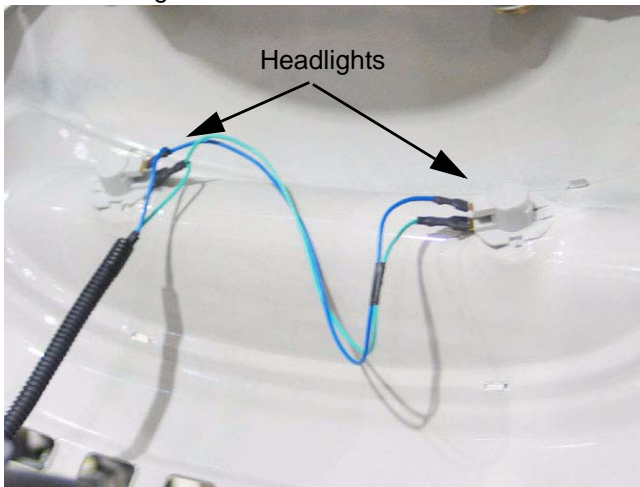

Figure 39.11

- The blue wire carries alternator current, the green wire is a ground.

39.12. The 20A fuse is located near the RMC module / key switch assembly, under the dash panel. See Figure 39.12.

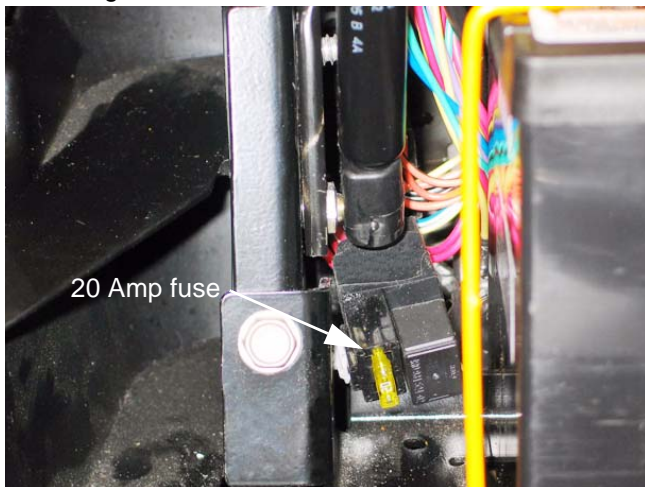

Figure 39.12

- The solid red wire feeds the fuse with power picked-up from the battery cable connection to the "hot" post of the starter solenoid.

- The red wire with white trace carries fused power to the B terminal on the key switch.

NOTE: On units with an auxiliary power point a second red wire with white trace will supply a 5 amp service to the power point.

CAUTION: DO NOT PUT A CIGARETTE LIGHTER IN THIS POWER POINT. This will cause the fuse to blow and can seriously damage the harness.

- A failed fuse will disable most of the tractor's electrical system.
- Remember that a failed fuse has done its job of protecting the rest of the circuit from an overload. If a fuse blows, figure-out why and correct the core problem before returning the tractor to service.

39.13. Refer to the engine manufacturer's specifications to test the engine and charging systems.

39.14. **Ground issues:** It is relatively easy to track where power is on the positive side of the system. The negative side is frequently neglected, though it may account for just as many electrical problems as the positive side.

39.15. Most technicians' first instinct when testing ground paths is to set the multi meter to the Ohms scale (Ω) and look for continuity using resistance as a measurement. This method does give a rough idea if the circuit is complete or not.

39.16. Resistance is not the most definitive scale for identifying circuits that are complete, but have reduced current carrying capacity because of bad connections, physical damage, or corrosion.

39.17. As a point of illustration, a short length of 12 or 14 gauge stranded wire can be stripped at the ends to facilitate an Ohm reading. See Figure 39.17.

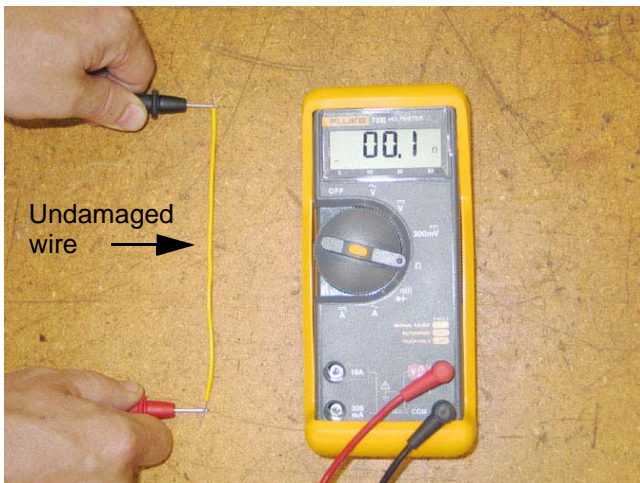

Figure 39.17

39.18. For comparison, strip away insulation at the middle of the wire, and snip strands until only a few remain. Repeat the Ohm reading. There will not be a substantial change. See Figure 39.18.

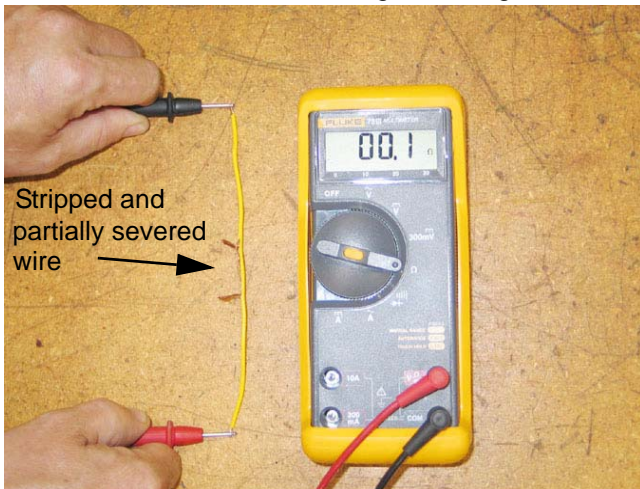

Figure 39.18

- While the actual resistance did not change, the ability of the whittled-down length of wire to carry current is vastly reduced.
- Similar effects occur when a terminal is not firmly crimped, a connection is loose, insulated by paint or corrosion, or the wire is chafed, cut, or corroded.

39.19. A more effective way to identify this reduced current carrying capacity is to look for “voltage drop”.

39.20. Voltage drop tests are useful on both the positive or the negative side of the system. We will concentrate on the negative side to begin with. See Figure 39.20.

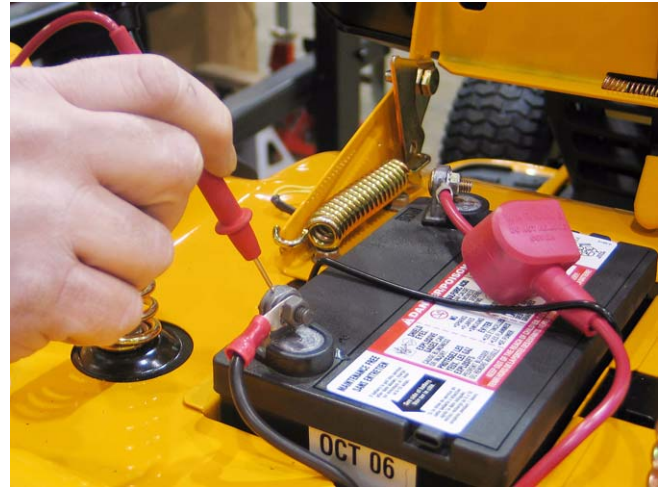

Figure 39.20

- Ultimately, any negative current should find its way back to the negative post of the battery.
- To check ground-side voltage drop: set-up a multi meter to measure 12V DC.
- Make a good electrical connection between the black (-) probe and the negative post on the battery.
- Make a good electrical connection between the red (+) probe and the suspect point of ground.
- Power-up the circuit in question.
- The voltage that shows-up on the meter is the power that is not following the intended path back to the negative battery post.
- Voltage drop on a good circuit should be less than 0.1 volts. A voltage drop reading on the meter of greater than 0.2 volts indicates a fairly substantial problem that demands attention.

Series 1000 and 1500

39.21. As an example, if the starter solenoid does not engage properly, check for voltage drop between the ground point for the starter solenoid and the negative post on the battery. See Figure 39.21.



Figure 39.21

39.22. With the starter engaged, this machine exhibited a voltage-drop reading beyond 0.30 volts, indicating a poor ground connection.

39.23. A similar ground-side test on a tractor with a slow-cranking starter motor can be conducted between the engine block and the negative battery post. See Figure 39.23.



Figure 39.23

39.24. With the starter engaged, this machine exhibited a voltage-drop reading beyond 0.30 volts, indicating a poor ground connection.

39.25. Individually, these readings should lead a technician to inspect the connection between the solenoid and the ground path (e.g. mounting hardware, green wire with eyelet beneath head of solenoid mounting bolt), or the engine and the frame (e.g. loose or rusty engine mounting bolts).

39.26. If both of these readings were found on the same tractor, a common point in the system would be the primary suspect (e.g. poor connection between negative battery cable and frame).

39.27. Applying this principle to the positive side of the system: See Figure 39.27.

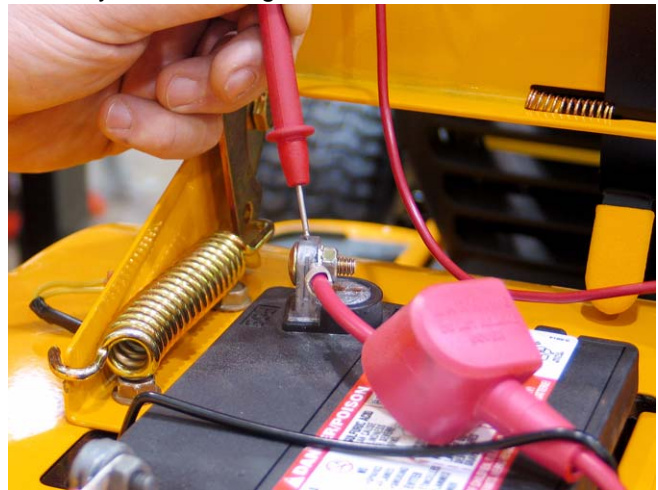

Figure 39.27

- Ultimately, any positive current should find its way from the positive post of the battery to its destination through the wiring harness.
- To check hot-side voltage drop: set-up a multi meter to measure 12V DC.
- Make a good electrical connection between the red (+) probe and the positive post on the battery.
- Make a good electrical connection between the black (-) probe and the suspect point of the circuit.
- Power-up the circuit in question.
- The voltage that shows-up on the meter is the power that is not following the intended path back to the negative battery post.
- Voltage drop on a good circuit should be less than 0.1 volts. A voltage drop reading on the meter of greater than 0.2 volts indicates a fairly substantial problem that demands attention.

39.28. As an example, if the tractor had a slow-turning starter, the ground-side voltage drop measured below 0.1 volts, and there was not a parasitic load on the engine (e.g. PTO clutch that is not fully disengaged), it would be logical for the technician to check voltage drop to the starter. See Figure 39.28.



Figure 39.28

39.29. With the starter motor engaged, the voltage drop reading here is nearly 0.6 volts, indicating a serious problem in the heavy-gauge circuit between the starter and the battery.

39.30. Checking voltage-drop at various points along the circuit can help pin-point the problem.

- Check voltage-drop at the output lug on the starter solenoid:
If there is a significant difference, the problem lies between the lug on the solenoid and the lug on the starter.
If there is little change, the problem lies further up-stream.
- Check voltage drop at the input lug on the solenoid:
If there is significant difference between the reading here and the reading at the output lug (greater than 0.10 volt), then the contacts inside the solenoid may be burned.
If there is little change, the problem lies further up-stream, between the battery and the solenoid.
- Results may be cross-checked by testing voltage drop across the two posts of the starter solenoid while cranking the starter motor.

39.31. This test may also be applied to the light gauge circuits on the tractor.

39.32. Switches may be bench tested using an Ohm meter. Generally speaking, safety switches will have less than 0.2Ω through the contacts.

39.33. On MTD switches:

- Normally Closed contacts are identified by the letters "NC" stamped on the spades that connect to those contacts.
- Paired spades (going to the same set of contacts) are next to each-other flat-to-flat (not edge to edge).
- It is good to test switch contacts in both modes: open and closed, confirming that each set of contacts is neither shorted nor faulted. See Figure 39.33.



Figure 39.33

D17.

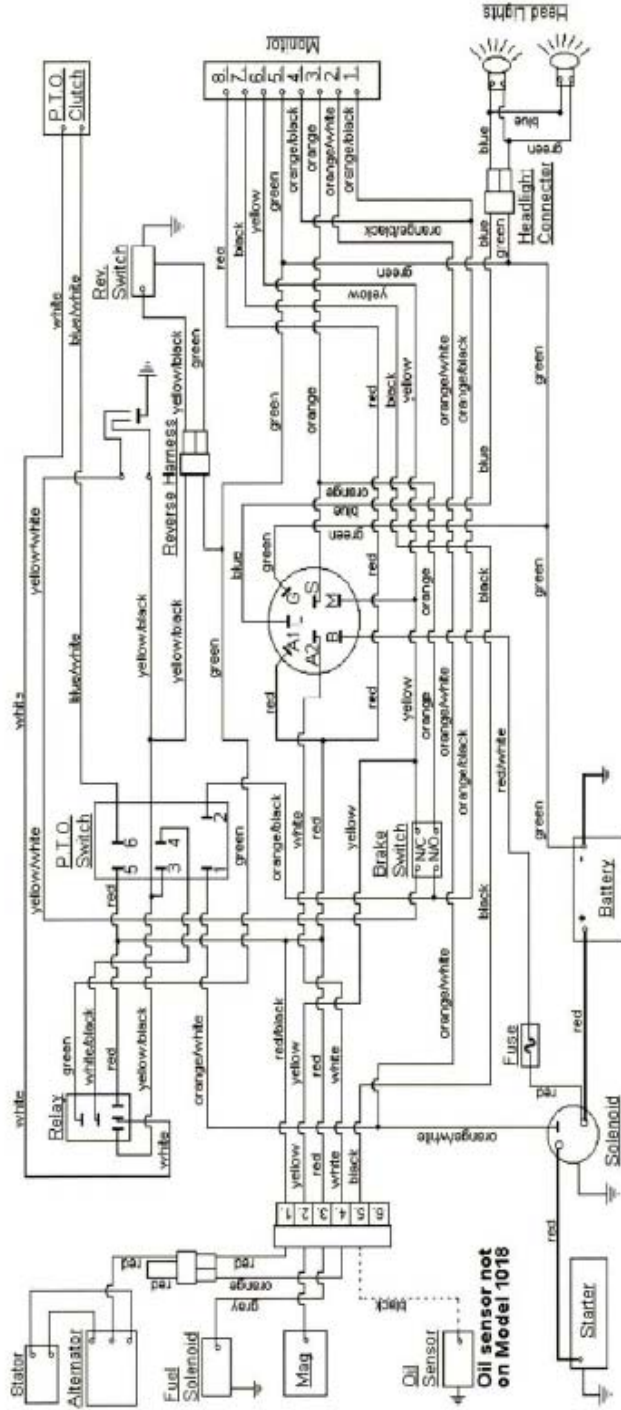

KEY SWITCH

OFF	M+G+A1
RUN w/LIGHTS	B+A1 / L+A2
RUN	B+A1
START	B+S+A1

DASH MONITOR

1:	P.T.O. +	5:	GROUND
2:	P.T.O. -	6:	NC CONNECTION
3:	BRAKE +	7:	LOW OIL
4:	BRAKE -	8:	HOUR METER

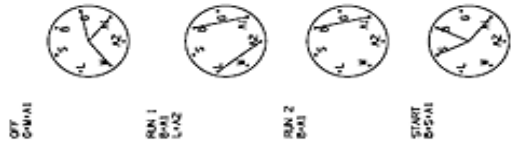
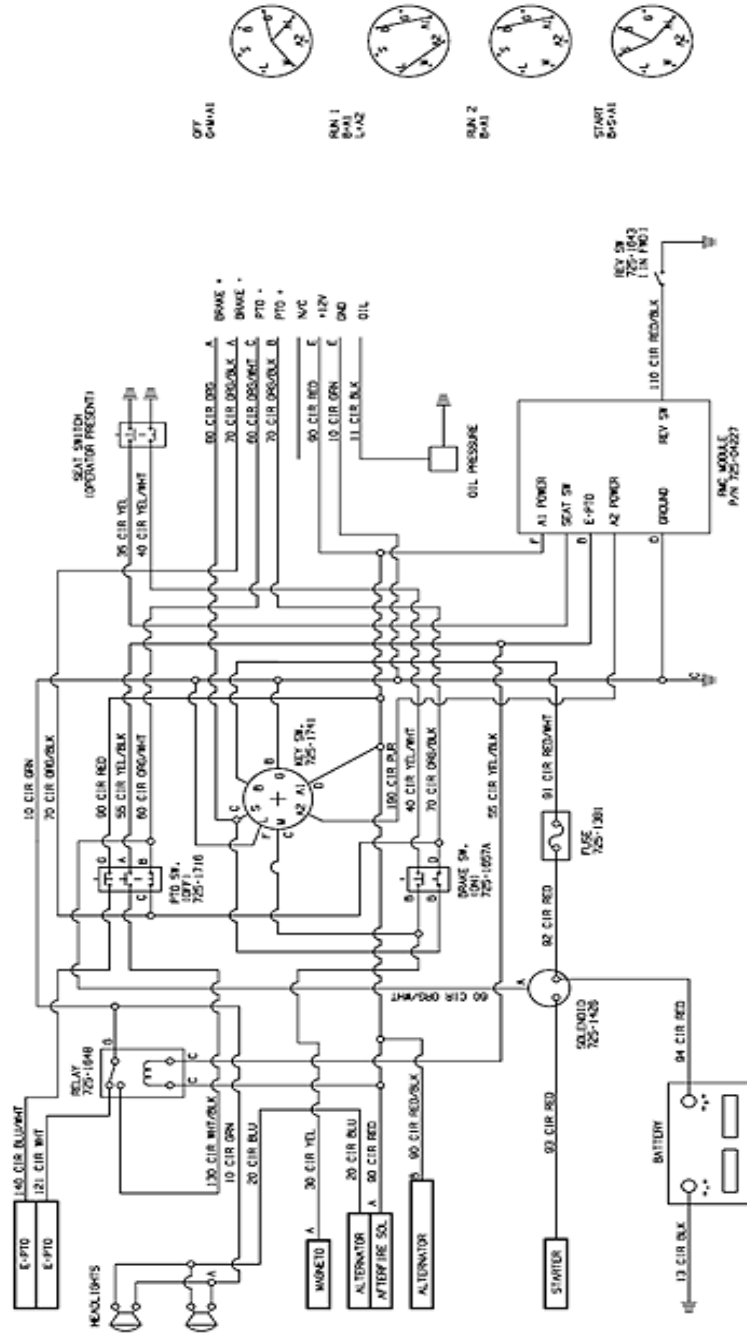

RMC wiring schematic drawing

