



# Blue Ribbon Service

**Form GSS-1292**

**International<sup>®</sup>  
Cub<sup>®</sup> Cadet Tractor  
Engine**

**File in Tractor Service Manual**

**INTERNATIONAL HARVESTER COMPANY  
180 NORTH MICHIGAN AVE. CHICAGO 1, ILLINOIS**

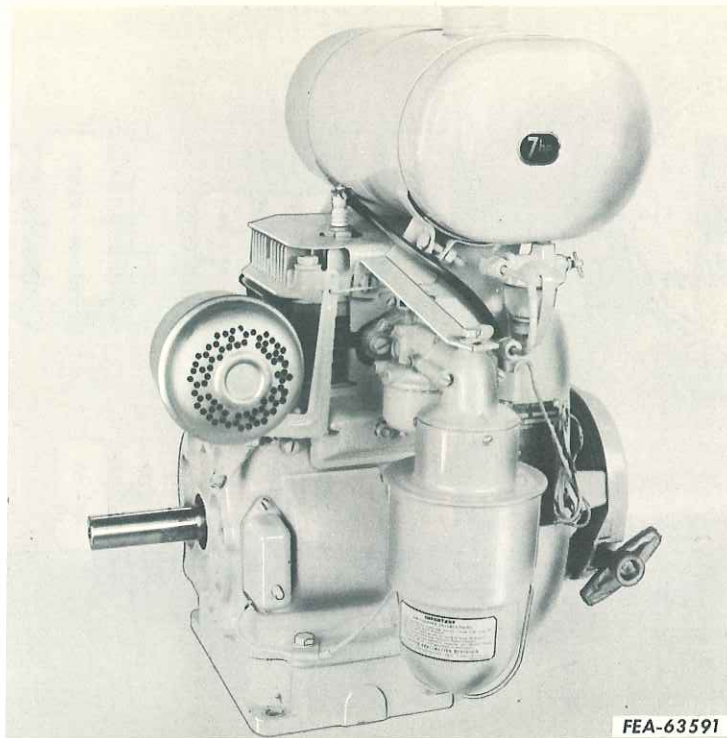

**Illust. 1. Left front view of engine with recoil starter.**

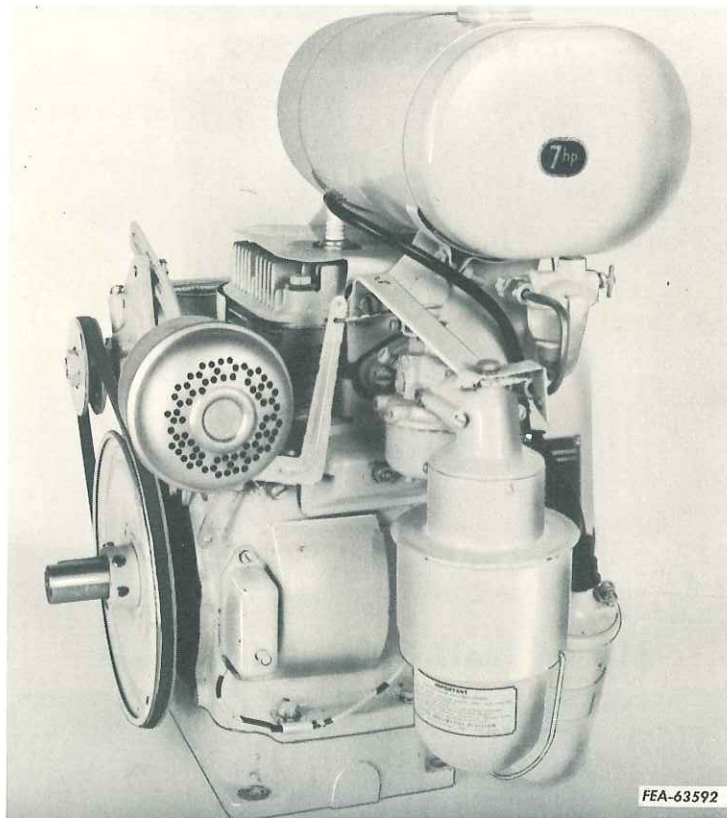

**Illust. 2. Left front view of engine with electric starting.**



# CONTENTS

|   |    |
|---|----|
| <b>Specifications</b> . . . . .                   | 4  |
| <b>Engine</b>                                     |    |
| <b>Removal</b>                                    |    |
| Electric Starting . . . . .                       | 7  |
| Manual Starting . . . . .                         | 7  |
| <b>Disassembly</b> . . . . .                      | 7  |
| <b>Inspection and Repair</b>                      |    |
| Reboring Cylinder Block . . . . .                 | 9  |
| Crankshaft . . . . .                              | 9  |
| Connecting Rod . . . . .                          | 9  |
| Piston . . . . .                                  | 9  |
| Piston Pin . . . . .                              | 9  |
| Valves, Seats and Guides . . . . .                | 10 |
| <b>Reassembly</b>                                 |    |
| Governor . . . . .                                | 10 |
| Valve Tappets and Camshaft . . . . .              | 11 |
| Installation of Crankshaft . . . . .              | 11 |
| Bearing Plate . . . . .                           | 12 |
| Piston and Rod Assembly . . . . .                 | 12 |
| Attaching Rod to Crankshaft . . . . .             | 12 |
| Installation of Oil Seals on Crankshaft . . . . . | 13 |
| Oil Base . . . . .                                | 13 |
| Installing and Setting Valves . . . . .           | 14 |
| Cylinder Head . . . . .                           | 14 |
| Breather Assembly . . . . .                       | 14 |
| Magneto . . . . .                                 | 15 |
| Flywheel . . . . .                                | 15 |
| Breaker Points . . . . .                          | 16 |
| Carburetor . . . . .                              | 16 |
| Governor Arm and Linkage . . . . .                | 16 |
| <b>Fuel System</b>                                |    |
| General Information . . . . .                     | 16 |
| Carburetor Adjustment . . . . .                   | 17 |
| Disassembly of Carburetor . . . . .               | 18 |
| Cleaning Carburetor Parts . . . . .               | 18 |
| Reassembly of Carburetor . . . . .                | 18 |
| <b>Governor</b>                                   |    |
| Throttle Control . . . . .                        | 20 |
| Governor Adjustment . . . . .                     | 20 |
| <b>Electrical System</b>                          |    |
| Magneto Ignition . . . . .                        | 20 |
| Battery Ignition . . . . .                        | 21 |
| Motor-Generator . . . . .                         | 21 |
| Current-Voltage Regulator . . . . .               | 22 |
| Ignition Timing . . . . .                         | 25 |
| Breaker Assembly . . . . .                        | 25 |
| Spark Plug . . . . .                              | 25 |
| Testing Condenser . . . . .                       | 25 |
| <b>Recoil Starter</b>                             |    |
| Removal . . . . .                                 | 26 |
| Disassembly . . . . .                             | 26 |
| Inspection and Reassembly . . . . .               | 27 |
| Installation on Engine . . . . .                  | 27 |





## SPECIFICATIONS - Continued

### Piston

|   |                       |
|---|-----------------------|
| New (Measured just below oil ring 90 degrees from piston pin) . . . . . | 2.8690 to 2.8695 inch |
| Maximum allowable undersize (for wear) . . . . .                        | 2.867 inch            |
| Piston ring end gap . . . . .   | .007 to .017 inch     |

### Valve stem (diameter)

|  |                     |
|--|---------------------|
| Intake (New) . . . . .                           | .3105 to .3110 inch |
| Maximum allowable undersize for wear . . . . .   | .3090 to .3095 inch |
| Exhaust (New) . . . . .                          | .3090 to .3095 inch |
| Maximum allowable undersize (for wear) . . . . . | .308 inch           |

### Valve guides (inside diameter)

|  |                   |
|--|-------------------|
| Intake and exhaust (New) . . . . .                                 | .312 to .313 inch |
| Intake and exhaust maximum (allowable oversize for wear) . . . . . | .315 inch         |

|   |                    |
|---|--------------------|
| Valve Guide Depth from top of block . . . . . | 1-5/16 inch        |
| Tappet clearance in block . . . . .           | .0005 to .002 inch |
| Camshaft running clearance . . . . .          | .001 to .0025 inch |
| Camshaft end clearance . . . . .              | .005 to .020 inch  |
| Valve clearance (stem end)                    |                    |
| Intake (Cold) . . . . .                       | .006 to .008 inch  |
| Exhaust (Cold) . . . . .                      | .016 to .018 inch  |

### Valve seat inserts (service only)

|                   |   |
|-------------------|---|
| Intake . . . . .  | Bore 1.4995 to 1.5005 inch<br>Depth .224 to .229 inch |
| Exhaust . . . . . | Bore 1.2595 to 1.2605 inch<br>Depth .234 to .239 inch |

### Current-voltage regulator

|                          |                    |
|--------------------------|--------------------|
| Make and Model . . . . . | Delco-Remy 1118999 |
| Ground . . . . .         | Negative           |
| Voltage regulator        |                    |
| air gap . . . . .        | .075 inch          |
| setting range . . . . .  | 13.6 to 14.5 volts |
| adjust to . . . . .      | 14 volts           |

### Cut-out Relay

|                           |                  |
|---------------------------|------------------|
| air gap . . . . .         | .020 inch        |
| point opening . . . . .   | .020 inch        |
| closing voltage . . . . . | 11.8 to 14 volts |
| adjust to . . . . .       | 12.8 volts       |

## SPECIFICATIONS - Continued

---

---

### Motor-generator

|   |                    |
|---|--------------------|
| Make and Model . . . . .                  | Delco-Remy 1101951 |
| Rotation (viewing drive end) . . . . .    | CC                 |
| Brush spring tension . . . . .            | 28 oz.             |
| Field current (at 80 degrees F) . . . . . |                    |
| amps . . . . .                            | 1.5 to 1.6 amps    |
| volts . . . . .                           | 12 volts           |

### Cold output

|                           |          |
|---------------------------|----------|
| amps . . . . .            | 15 amps  |
| volts . . . . .           | 14 volts |
| approximate rpm . . . . . | Low idle |

### No load test:

|                 |              |
|-----------------|--------------|
| volts . . . . . | 11           |
| amps . . . . .  | 12 to 18     |
| RPM . . . . .   | 1600 to 1900 |

### Carburetor

|  |                               |
|--|-------------------------------|
| *Float setting . . . . .                     | $3/16 \pm 1/64$ inch          |
| Idle speed adjusting screw setting . . . . . | $3/4$ to $2-1/4$ turns open   |
| High speed adjusting screw setting . . . . . | $1-1/4$ to $2-3/4$ turns open |

\*Measure between top of float (free end) and casting body.

### Recoil starter

|                                    |         |
|------------------------------------|---------|
| Preload on rewind spring . . . . . | 4 turns |
|------------------------------------|---------|

# ENGINE

## Removal (Electric starting)

1. Disconnect ground cable at battery.
2. Disconnect wire from positive side of coil.
3. Close valve on sediment bowl and remove the fuel line.
4. Remove fuel tank with brackets and sediment bowl attached.
5. Remove air cleaner and carburetor.
6. Remove wires from motor-generator.
7. Remove motor-generator drive belt and mounting bracket.
8. Loosen the bolts through frame and clutch shaft bearing support and remove the drive belt.
9. If crankshaft is to be removed from engine loosen the crankshaft pulley nut.
10. Remove the four cap screws securing the engine to the frame and lift the engine free.

## Removal (Manual starting)

Disregard steps 1, 2 & 3 unless the magneto is to be serviced or the crankshaft is to be removed.

1. Remove the four cap screws securing pedestal to tractor frame and remove recoil starter unit.
2. Disconnect yellow wire at ignition switch.
3. Loosen the crankshaft pulley nut.
4. Remove the throttle control from the engine.

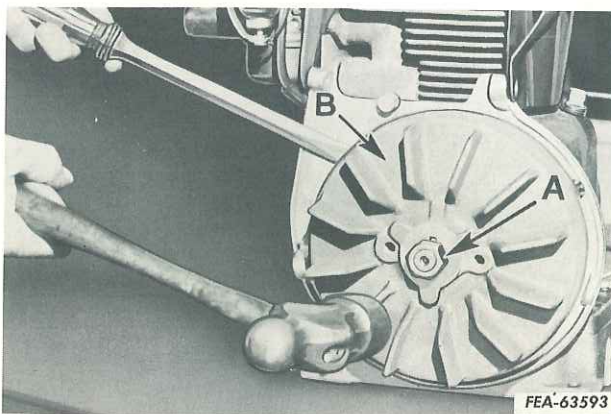

Illust. 3. Removing flywheel.

5. Close the fuel shut-off valve.
6. Remove the fuel line.
7. Remove the fuel tank and fuel tank brackets from the engine.
8. Remove the air cleaner and carburetor.
9. Loosen the three bolts securing the clutch shaft bearing support and remove the drive belt.
10. Remove the four cap screws securing the engine to the frame and lift the engine free.

## Disassembly

1. Drain engine oil.
2. Disconnect the coil-to-breaker point wire (if so equipped) at the points and remove coil and bracket from engine.
3. Remove breaker point assembly and breaker point push rod.
4. Remove rotating screen and drive pulley assembly.
5. Remove blower housing, cylinder baffle and head baffle.
6. Remove breather plate assembly.
7. Remove the flywheel and (magneto, if equipped).

**Note:** The flywheel is mounted on a tapered shaft and can be removed without the use of a puller. If flywheel does stick on the shaft, screw flywheel nut flush with end of shaft and rap end of the shaft sharply with a hammer. Illust. 3.

8. On electric starting engines, remove the two Allen set screws in the front pulley hub. Remove the pulley with two long screwdrivers. Place the screwdrivers between the pulley and the crankcase, 180 degrees apart. Pry against the pulley near the crankshaft to prevent bending the pulley.

9. Remove the cylinder head.

10. Compress the valve springs and remove the valve keepers, springs, retainers and valves. Illust. 4.



11. Remove the oil base.

12. Remove connecting rod cap. Remove ridge at top of cylinder wall, if present, and slide piston and rod out the top of the cylinder block.

13. Remove crankshaft, oil seals and if necessary press out the crankshaft main ball bearings.

Note: It may be necessary to press the crankshaft out of the cylinder block. Bearing plate should be removed first if this is done. The bearing plate can be removed with a bridge type puller, using the two tapped holes in the bearing plate.

14. Turn the cylinder block upside down and using a small punch, drive out camshaft pin from front side of engine. The pin will slide out easily after it is driven free of front side of cylinder block.

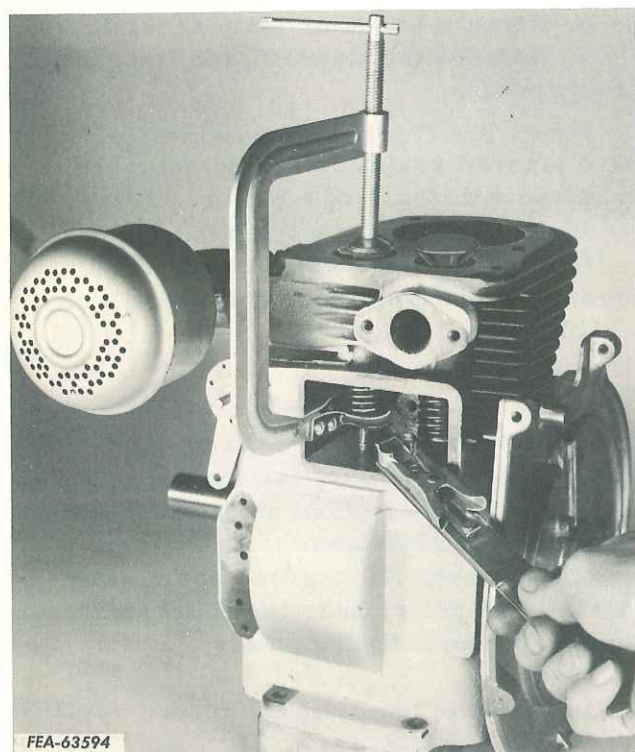

Illust. 4. Valve spring compressed to remove or install keepers.

15. Remove the camshaft and valve tappets. Save the washer type shim or shims located between the end of the camshaft (opposite camshaft gear), and the cylinder block. These shims will be reused in reassembly.

16. Unscrew the governor bushing nut and remove the throttle bracket and speed control disc. The governor cross shaft can now be removed by sliding the pilot end from its bearing, then inward and downward from inside the crankcase.

17. Loosen the screw (located to lower right of governor bushing nut) until governor gear is free to slide up, off the stub shaft. Do not remove the screw.

18. The valve guides can be removed using a 1-4 inch cap screw threaded the entire length, approximately six inches long. Use two nuts one at the top of the cap screw and one at the bottom as shown in Illust. 5. Make sure cap screw is centered in guide and nut is smaller than O.D. of valve guide.

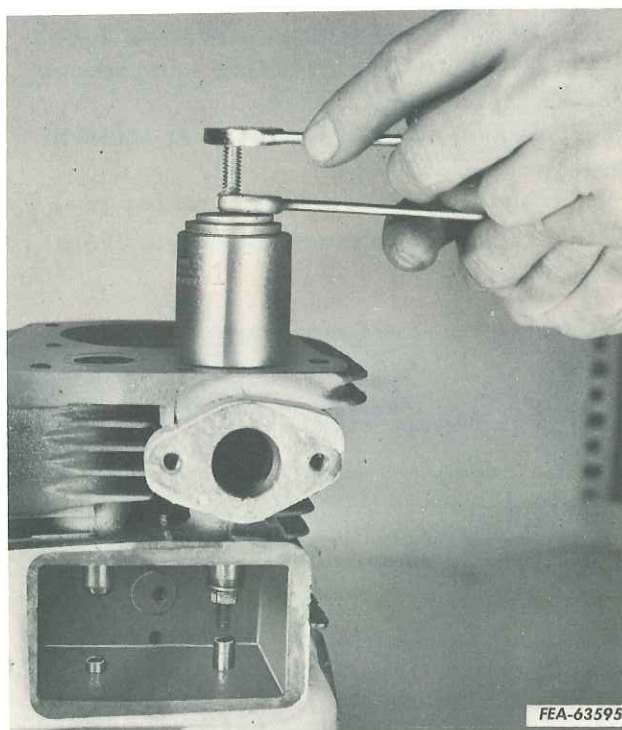

Illust. 5. Removing valve guides.

## Inspection and Repair

Clean all parts and inspect them to determine which parts are reusable.

### Reboring Cylinder Block

1. The cylinder should be rebored if badly scored, tapered, or out of round more than .005.

2. Always hone or rebore to exactly .010, .020, or .030 over standard bore size of 2.875.

3. Use an inside micrometer or dial gauge to determine cylinder size and condition before and during honing.

4. If honed to nearest available oversize mentioned in step 2 above, oversize piston and ring assemblies can be used without additional fitting.

5. Any commercial cylinder hone can be used with either a drill press or a portable electric drill. The drill press is preferred, for it is important to keep bore in alignment with crankshaft cross-bore.

6. Finish by washing cylinder walls with SAE-10 oil and a clean cloth.

### Crankshaft

1. Check for score marks and metallic pick-up. Superficial score marks can be cleared up with crocus cloth soaked in oil.

2. With a micrometer, check journal for out of round. Correct crankpin size is 1.1855 to 1.1860. If out of round, replace shaft or regrind to .010 undersize.

3. Check gear, keyway and tapered part of shaft for wear. If worn, replace shaft.

### Connecting Rod

1. Check rod for wear, score marks, running clearances, and side clearance. Replace rod if worn beyond high limit of clearances shown in specifications.

2. Connecting rod bearings are an integral part of the rod and not separately replaceable.

3. Connecting rods .010 undersize are available for reground crankshafts.

### Piston

1. If cylinder block does not require reboring and old piston is free of score and scuff marks, check piston ring grooves and lands.

2. Clean grooves and fit new rings.

3. With rings in place, check clearance with a feeler gauge. Replace piston if a .005 feeler can be inserted between ring and land.

4. When inserted in cylinder, piston ring end clearance should be between .007 and .017.

5. NEVER RE-USE OLD RINGS.

### Piston Pin

1. Very little wear takes place on piston pin or in piston bosses.

2. If it is necessary to replace connecting rod because of wear at large end of rod, it is advisable to install a new piston pin.

3. Oversize pins are available.

4. Assemble piston to connecting rod. Use a commercial rod aligner. Piston must be square with cylinder bore and crankshaft.



## Valves, Seats and Guides

1. Check clearance of valve stems in guides.

2. If worn, replace valve guides. Press new guide into a depth of 1-5/16 inch below top surface of cyl. block. It will be necessary to ream guides to gain correct fit. Refer to Specifications for proper clearance.

3. Intake valve seat is machined into block. An insert is available for service. Refer to Specifications for bore and depth for machining block before installing the insert.

4. The exhaust valve seat is a Stellite insert. An oversize insert is available for service. Refer to Specifications for bore and depth for machining block before installing the insert.

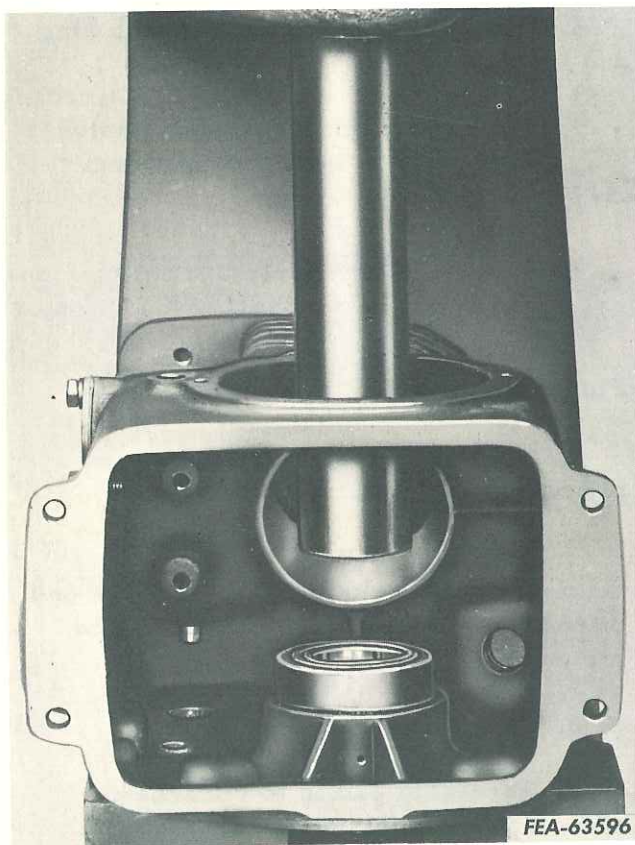

Illust. 6. Installing rear main bearing.

5. The seating surfaces should be held as nearly as possible to 1/32 inch in width. Seats with more than 1/16 inch seating surface should be reconditioned with 45 degree or 15 degree cutters and ground to form proper seat.

6. Check the governor stub shaft for wear. Do not remove the shaft unless it needs to be replaced. To remove the shaft, remove the expansion plug and drive the shaft into the inside of breather, or or valve spring compartment.

## Reassembly

Install rear main bearing by pressing it into cylinder block with shielded side facing to inside of block. Illust. 6.

## Governor

1. Install the governor stub shaft and expansion plug, if they were removed. See Illust. 7.

2. Place spacer washer on stub shaft and slide governor gear assembly into place.

3. Place cylinder block on its side. Slide governor cross shaft into place from inside of block. Make sure tab on governor shaft is against pin in end of governor gear.

4. Place speed control disc on governor bushing nut and thread bushing nut into block, clamping throttle bracket into place.

5. Governor shaft can be adjusted for end clearance by moving needle bearing in block. Set bearing to allow a slight back-and-forth movement of the shaft.

6. Tighten holding screw from outside of cylinder block. This screw prevents governor gear from sliding off stub shaft during assembly.



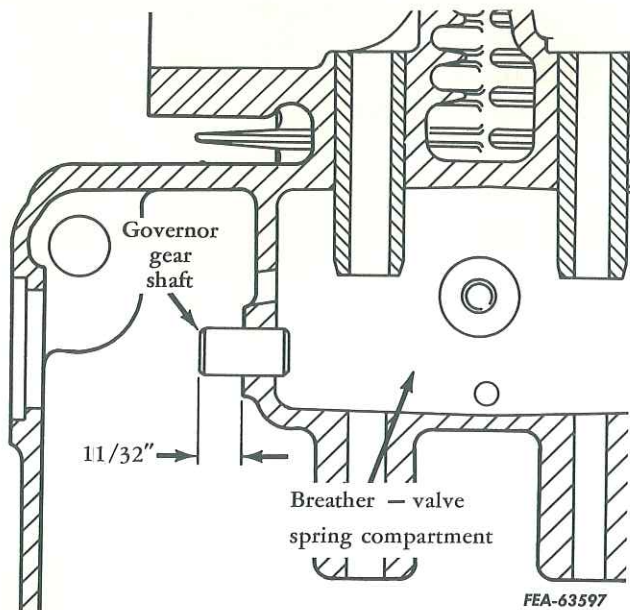

Illust. 7. Height of governor gear shaft.

7. Rotate governor gear assembly to be sure holding screw does not contact weight section of gear.

### Valve Tappets and Camshaft

1. Turn cylinder block upside down and place valve tappets in tappet guides.

2. Before installing camshaft assembly in block, breaker cam must be correctly inserted between springs of spark advance systems to insure proper spark timing. Spark timing marks (A and B, Illust. 8) on cam and spark-advance side of camshaft gear must coincide. Spread springs in direction indicated by arrows on flyweight and insert cam.

3. Position the camshaft in the block with washer type shims (that were removed during disassembly) between the end of the camshaft and the bearing plate side of the block. Slide the camshaft pin through the shims and camshaft from the bearing plate side (Illust. 9), and press into front side of block.

4. Check camshaft end clearance. End clearance should be from .005 to

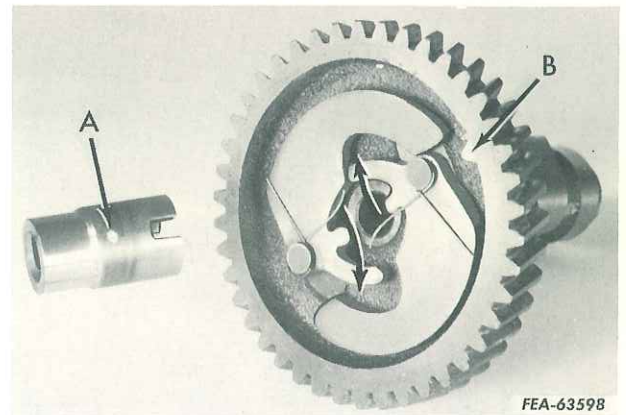

Illust. 8. Camshaft and breaker cam, A and B are timing marks.

.020. Clearance can be changed by adding or removing shims as required.

### Installation of Crankshaft

1. The installation of crankshaft in cylinder block is shown in Illust. 10.

2. Timing marks are provided crankshaft and camshaft gears for correct timing of engine. When in place, mark between teeth of camshaft (B, Illust. 10) must line up with mark on shoulder of crankshaft (A, Illust. 10). Chalk timing mark positions for ease of viewing during assembly.

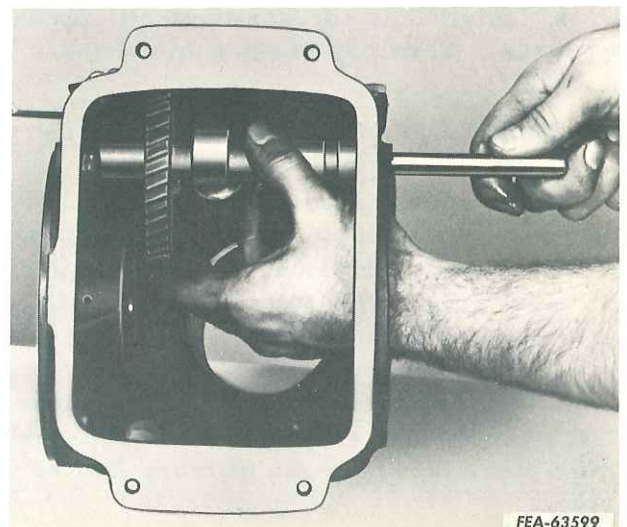

Illust. 9. Installing camshaft.

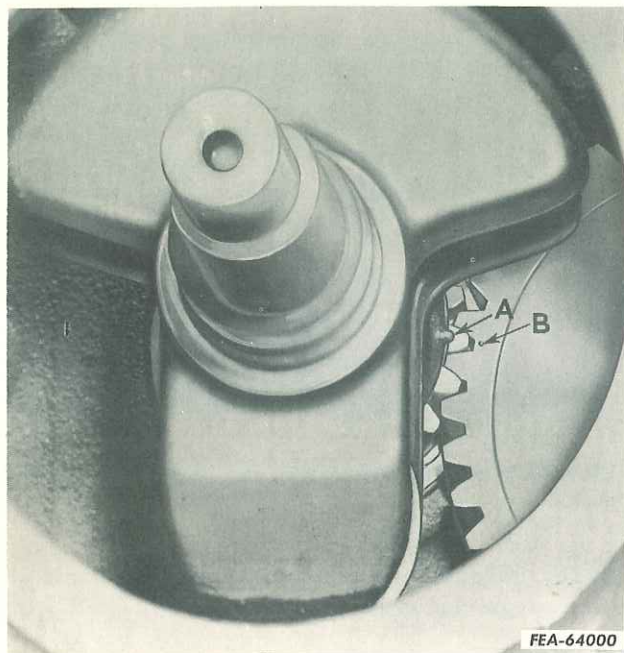

**Illust. 10.** Crankshaft installation A and B are timing marks.

### Bearing Plate

1. Press front main bearing, shielded side up, into bearing plate.
2. Place bearing plate and gasket on crankshaft.
3. Carefully press bearing plate assembly onto crankshaft and into block.
4. Install four cap screws with copper washers. Draw cap screws up evenly.

### Piston and Rod Assembly

1. Assemble piston to connecting rod and secure piston pin with retainer rings. Always use new retainer rings. Be sure retainer rings are fully engaged in grooves in piston bosses.
2. Before placing piston rings on piston, position rings in cylinder bore to be sure there is a ring gap of from .007 to .017.
3. Piston rings must be installed ac-



**Illust. 11.** Installing piston assembly.

ording to their markings. Install compression ring with groove or bevel up. Oil control rings can be installed either way. Install rings properly to gain correct ring function.

4. After rings are in proper position in correct grooves, oil complete assembly, stagger ring gaps so they are not in line and insert complete assembly into cylinder bore. Be sure connecting rod marking (A, Illust. 12) is toward flywheel side of engine. Use a ring compressor to prevent ring breakage during installation. Illust. 11.

### Attaching Rod to Crankshaft

1. After Piston Assembly is installed, place block on end and oil connecting rod and crank pin.
2. It is important that marks on connecting rod and cap (A, Illust. 12) line up and face flywheel end of engine. (B, Illust. 12.)



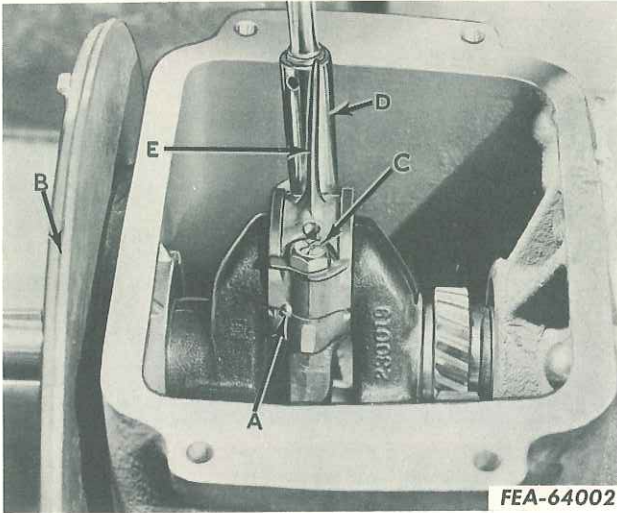

Illust. 12. Tightening connecting rod cap screws.

|                    |                   |
|--------------------|-------------------|
| A - Connecting Rod | C - Cap Screw     |
| Marks              | D - Socket Wrench |
| B - Bearing Plate  | E - Oil Slinger   |

3. Install connecting rod cap, lock and cap screws to connecting rod. Illust. 12.

4. Use a torque wrench to tighten cap screws to 200 inch pounds. Back off screws and tighten cap screws to 180 inch pounds. This two-step procedure will assure a tight fit of rod to crankshaft and avoids possibility of screws tightening in threads while rod remains loose on shaft.

Note: Be careful not to bend oil slinger (E, Illust. 12).

### Installation of Oil Seals on Crankshaft

**IMPORTANT:** The oil seal at the front of the engine is countersunk 1/8 inch in factory production. This is not necessary for service. The service oil seal is to be installed flush with the crankcase. Since the seal will be seating on a new portion of the crankshaft, it is extremely important that all paint and any foreign material be removed from the sealing surface before the new seal is installed.

1. Place seal protector tool FES-54-5 over the crankshaft at the front of the engine and protector tool FES-54-4 over the crankshaft at the flywheel end of the engine.

2. Lubricate the seals and slide them onto the protector tools. Drive the front seal in flush with the cylinder block and the rear seal flush with the bearing plate with seal driver FES-54-6. (Illust. 13.)

Note: The two seal protector tools and the driver can be ordered from:

Service Tools Inc.,  
1901 S. Indiana Ave.  
Chicago 16, Illinois

### Oil Base

1. Assemble oil base to block with four screws. Illust. 14.

2. It is important that a new gasket be used to prevent oil leakage.

3. Use 5/16 inch pilot studs to align cylinder block, gasket and oil base.

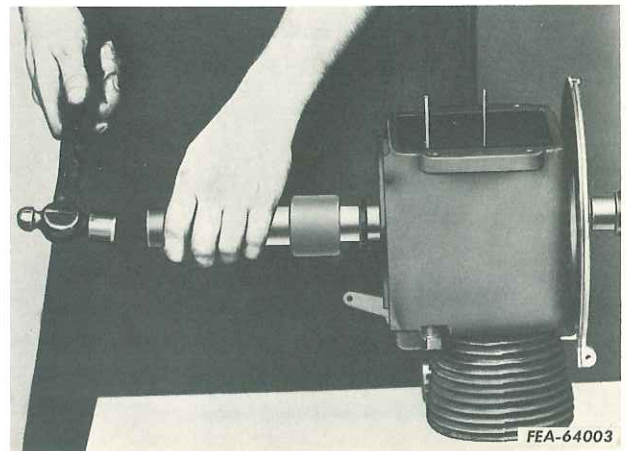

Illust. 13. Installing oil seal on front side of engine.



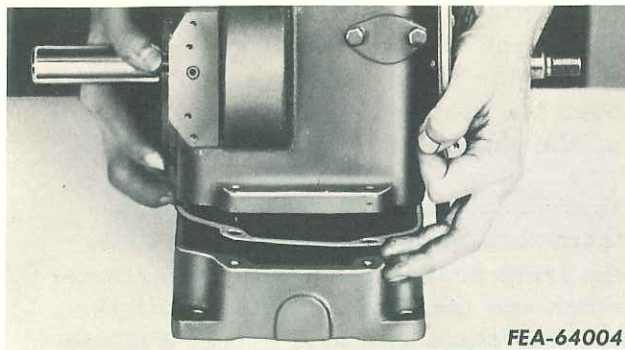

Illust. 14. Installing oil base.

### Installing and Setting Valves

1. Valves, valve seats and ports should be thoroughly cleaned. Valves and seats should be ground and lapped-in to obtain a good valve seal. Keep valve seat from 1/32 inch to 1/16 inch in width.

2. Illust. 15 illustrates checking valve clearance. Intake valve clearance should be .006/.008 cold. Exhaust valve clearance should be .016/.018 cold. Valves that do not have sufficient clearance must be removed and ends ground until desired clearance is obtained. **ENDS MUST BE GROUND SQUARE AND ALL BURRS MUST BE REMOVED.** If clearance is excessive install new valves.

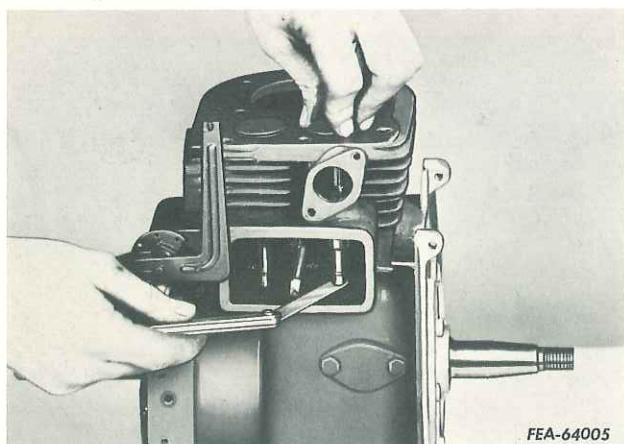

Illust. 15. Checking valve clearance.

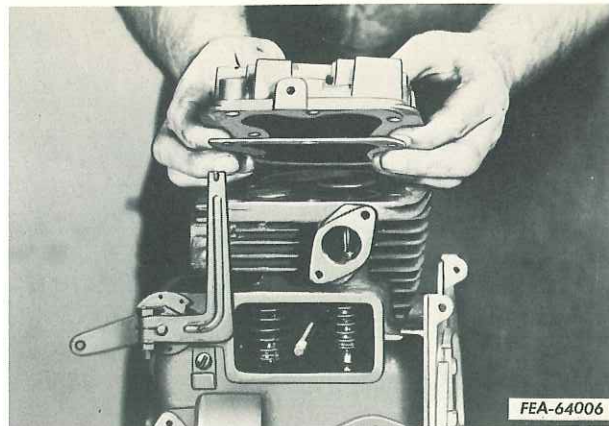

Illust. 16. Cylinder head assembly.

3. After correct clearance is obtained, remove valves and install valve springs and retainers. Replace valves, compress springs (using a spring compressor) (Illust. 2) and place locking key in grooves of valve stems.

### Cylinder Head

1. Always use a new gasket when head has been removed for service work. Illust. 16. It is recommended that head gaskets be soaked in water before assembly.

2. Check cylinder head on face plate to be sure gasket surfaces make good contact at all points.

3. It is important that head cap screws be tightened evenly and in steps until 200 inch pounds torque is reached. Illust. 17.

4. Install new spark plug and gasket and tighten to 27 foot pounds torque. Spark plug gap should be .025.

### Breather Assembly

1. The reed type breather valve maintains a slight vacuum in engine crankcase. All parts must be clean and in good condition. Parts can be replaced as necessary.

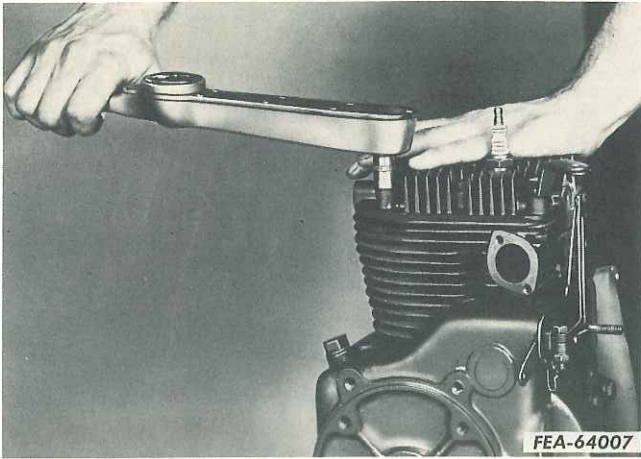

Illust. 17. Tightening cylinder head cap screws.

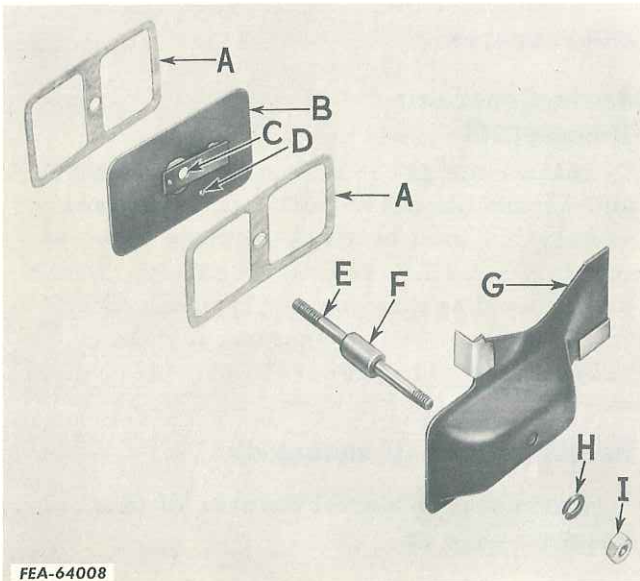

Illust. 18. Exploded view of breather and vent assembly.

|             |            |            |
|-------------|------------|------------|
| A - Gaskets | D - Hole   | G - Cover  |
| B - Plate   | E - Stud   | H - Washer |
| C - Reed    | F - Spacer | I - Nut    |

2. The correct order for assembly of breather is as follows: (Illust. 18)  
 A-Gasket, B-Plate and C-Reed, (D-small drilled hole must be at bottom of plate),  
 A-Gasket, E- Stud, F-Rubber spacer,  
 G-Cover, H-Lock washer and I-Nut.

3. Cover must be tight to prevent oil leaks.

## Magneto (If equipped)

1. Install square key in slot of crankshaft.

2. Illust. 19 shows magneto in position. Note how breaker lead and high tension spark plug cable are pulled through plate opening.

3. After magneto assembly has been fastened to bearing plate, rotating magnet is pressed onto crankshaft. Magnet is marked "ENGINE SIDE" for correct assembly.

## Flywheel

1. Place wave washer on crankshaft and place flywheel in position.

2. Install blower housing, starter pulley, lock washer, and flywheel nut. Torque the nut to 75 ft. lbs., place the engine on the tractor and secure the engine to the tractor frame with four mounting cap screws.

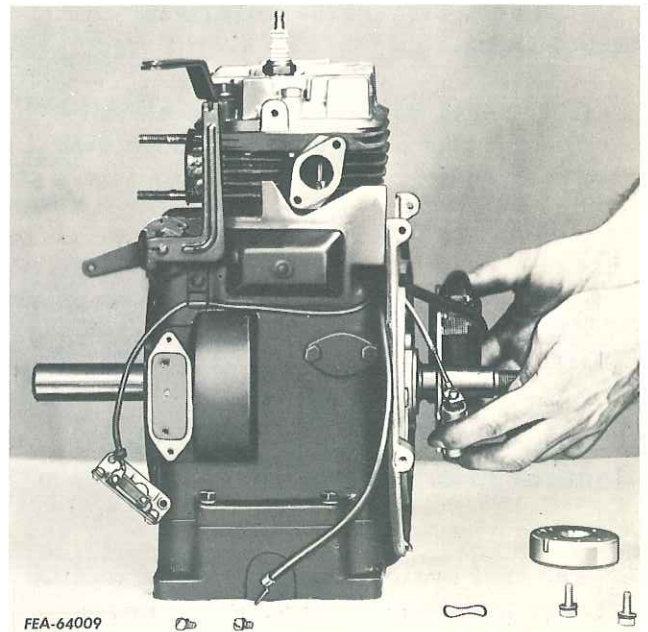

Illust. 19. Assembly of magneto.



## Breaker Points

1. Install push rod.
2. Fasten breaker in place with two screws.
3. Place cover gasket in position and attach magneto lead or coil lead.
4. Set breaker gap at .020. For precision ignition setting refer to Ignition Timing, page 25.
5. Make final adjustments before installing breaker point cover. Be sure breaker lead grommet is in place.
6. Fasten coil (if equipped) to blower housing.

## Carburetor

1. Insert a new gasket and assemble carburetor to intake port with two screws.
2. Refer to FUEL SYSTEM, page 17 for carburetor adjustment procedure

## Governor Arm and Linkage

1. Insert carburetor linkage in throttle arm.
2. Connect governor arm to carburetor linkage and slide governor arm onto governor shaft.

3. Position governor spring in speed control disc.

4. Before tightening clamp bolt, turn shaft counterclockwise as far as possible with a pair of pliers, pull governor arm (I, Illust. 23) as far as possible to left (away from carburetor), tighten nut and check for freedom of movement.

## Cylinder Baffles and Fuel Tank

1. Install the cylinder baffles and the head baffle.
2. Gasoline fuel tank and brackets are installed at the same time as the baffles.
3. Connect fuel line between filter and carburetor.

## Motor-Generator (If equipped)

Install the generator-cranking motor and adjust the drive belt to give approximately 1/4 inch of slack midway between the driven pulley and drive pulley. Refer to wiring diagram (page 21) under Electrical System of this manual for the proper electrical connections.

## Recoil Starter (If equipped)

Refer to the Recoil Starter of this manual, page 26.

Continue reassembly in the reverse order of disassembly.

# FUEL SYSTEM

## General Information

The fuel system consists of a gasoline storage tank, shut-off valve, sediment bowl, fuel line with connections, and carburetor.

Service difficulties with fuel systems usually originate from improper carburetor adjustments or dirt in one of the components. If gum forms in the components it will be necessary to completely disassemble and thoroughly clean the carburetor.



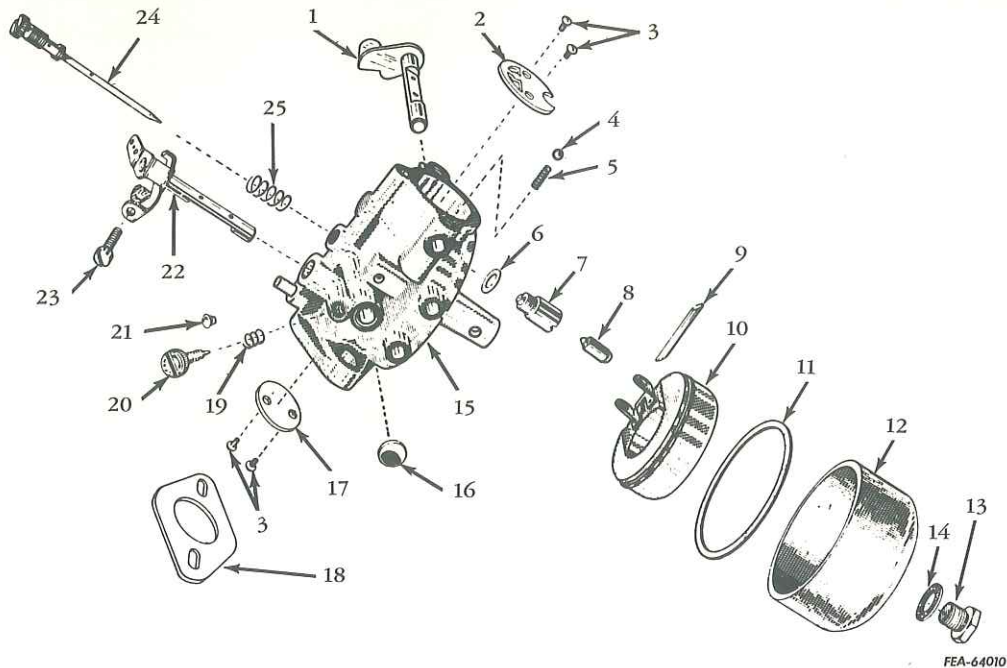

Illust. 20. Exploded view of carburetor.

- |                                   |                    |                                 |
|-----------------------------------|--------------------|---------------------------------|
| 1. Choke shaft and lever assembly | 10. Float          | 20. Idle adjustment screw       |
| 2. Choke valve                    | 11. Gasket         | 21. Rivet plug                  |
| 3. Screws                         | 12. Bowl           | 22. Throttle shaft              |
| 4. Choke shaft ball               | 13. Cap screw      | 23. Low idle stop screw         |
| 5. Choke shaft spring             | 14. Gasket         | 24. High speed adjusting needle |
| 6. Gasket                         | 15. Body           | 25. Spring                      |
| 7. Float needle seat              | 16. Expansion plug |                                 |
| 8. Float needle                   | 17. Throttle plate |                                 |
| 9. Float pin                      | 18. Gasket         |                                 |
|                                   | 19. Spring         |                                 |

### Carburetor Adjustments (Refer to Illust. 20)

The carburetor is adjusted at the factory and under normal operating conditions will not require readjusting. If readjustment is necessary because of fuel values and oil conditions, the following procedure is recommended:

1. Turn high speed adjustment screw (24) counter-clockwise two turns from closed position and start engine.

2. After engine has reached normal operating temperature, accelerate and check response. Place engine under full load and adjust high speed adjustment

screw (24) for leanest mixture that will still allow satisfactory acceleration and steady governor operation.

3. If engine misses and backfires under full load, high speed mixture is too lean. The high speed adjustment screw (24) must be turned counter-clockwise 1/4 turn at a time until condition is corrected.

4. If engine shows sooty exhaust and is sluggish under full load, high speed mixture is too rich. The high speed adjustment screw (24) must be turned clockwise 1/4 turn at a time until condition is corrected.

5. Final check of high speed adjustment; operate engine under full load and make any corrections necessary for smooth operation.

6. Idle adjustment screw (20) adjustments should be made at the same time as high speed adjustments screw (24) adjustments, as each effects the other.

7. The final idle adjustment should be made at an engine speed of not less than 1000 RPM. Adjust until smoothest idle is obtained.

Caution: Do not use force on high speed adjustment screw or idle speed screw -- they will be damaged.

### Disassembly of Carburetor (Refer to Illust. 20)

1. Remove carburetor from engine.
2. Remove bowl nut, gasket, and bowl.
3. Remove float pin, float, needle and needle seat, check float for dents, leaks and wear on float lip or in float pin holes.
4. Remove bowl ring gasket.
5. Remove idle speed screw (23) and high speed adjustment screw (24) and spring.
6. Remove throttle valve screws, valve, shaft and lever assembly.
7. Do not remove choke valve and shaft unless replacement of these parts is necessary.
8. A spring loaded ball retains choke in wide-open position.

Caution: Hold screw driver handle or small piece of wood over threaded hole in air horn (side opposite choke lever) to prevent ball from flying out when shaft is removed.

### Cleaning Carburetor Parts

1. Clean all parts in solvent. Gum is easily removed with an alcohol or acetone solvent.
2. Be sure any carbon deposits are removed from bore, especially where throttle valve seats in casting.
3. Blow out all passages with compressed air.
4. Replace all worn and damaged parts. ALWAYS USE NEW GASKETS.

### Reassembly of Carburetor (Refer to Illust. 20)

1. Install throttle, shaft and valve. Valve must be installed with trademark "C" on side towards idle port when viewing from flange side.
2. With valve screws loose and throttle lever set screw backed out, seat valve by tapping lightly with small screw driver. Hold in place while tightening screws.
3. Install needle seat, needle, float and float pin.
4. Set float level. With carburetor casting inverted and float resting lightly against needle in its seat, there should be 13/64 inch clearance between machined surface of casting and free end of float (side opposite needle seat).
5. Adjust by bending lip of float with small screw driver.
6. Install new bowl ring gasket, new bowl nut gasket and bowl nut. Tighten

securely after making sure bowl is centered on gasket.

7. Install high speed adjustment screw (24) assembly. Turn in until screw seats in nozzle and back out two turns.

8. Install idle adjusting screw as-

sembly (20). Back out approximately 1-1/2 turns after seating lightly against jet.

Caution: Do not jam into seat as this will damage idle adjustment screw.

## GOVERNOR

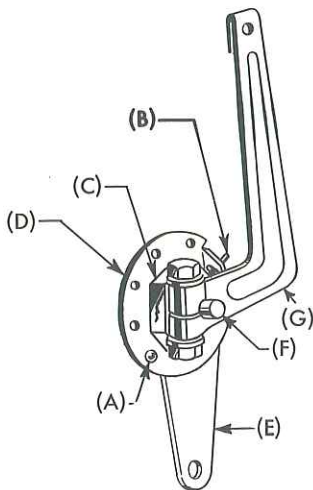

FEA-64011

Illust. 21.

- |                     |                        |
|---------------------|------------------------|
| A - Drive Pin       | D - Speed Control Disc |
| B - Governor Spring | E - Throttle Bracket   |
| C - Bushing Nut     | F - Governor Shaft     |
|                     | G - Governor Arm       |

The engine is equipped with a centrifugal governor and operating speed is determined by throttle control setting. The governor maintains engine speed under varying loads and serves as a top speed limiting device.

To change high speed setting:

1. Loosen bushing nut (C, Illust. 21) slightly.

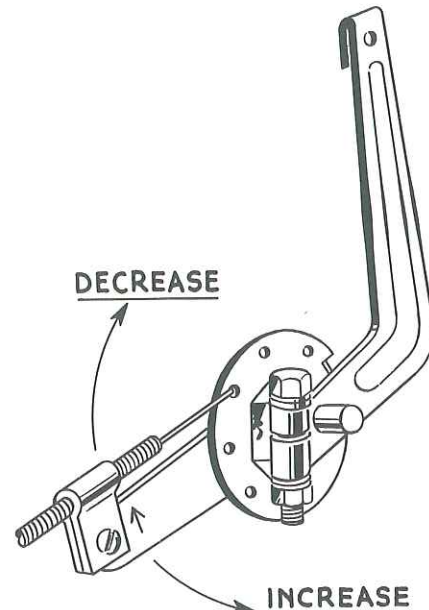

FEA-64012

Illust. 22. Speed range adjustments.

2. Moving throttle bracket (E, Illust. 21) counter-clockwise will rotate speed control disc, increasing tension on governor spring (B, Illust. 21), resulting in increased engine speed.

3. To decrease engine speed, move throttle bracket clockwise.

4. Tighten governor bushing nut (C, Illust. 21) to lock throttle bracket (E, Illust. 21) in desired position.

Caution: Do not apply excessive pressure on bushing nut.



## Throttle Control

### Installation and Adjustment:

1. With control handle in an open position, insert throttle wire into speed control disc in first hole clockwise from drive pin.

2. Install cable clamp and bolt to throttle bracket.

3. Operate control handle, rotating disc from idle to full speed.

Note: Throttle wire should be adjusted so that when throttle is in full speed position, stop "A" is just touching throttle control bracket "E" Illust. 21.

4. Operating speed range can be changed by moving throttle bracket as shown in Illust. 22.

## Governor Adjustment

Governors are set when the engines are assembled and should not require readjustment unless governor arm is loosened or removed from governor shaft.

1. To reset governor (Illust. 23), loosen nut which holds governor arm (I) to shaft (H).

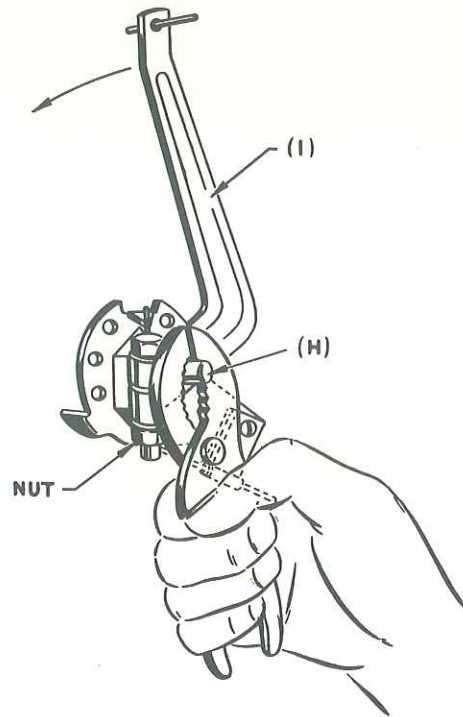

FEA-64013

Illust. 23. Resetting governor.

2. Turn shaft counter-clockwise as far as possible with a pair of pliers.

3. Pull arm (I) all the way to left (away from carburetor). Tighten nut. Check for freedom of movement.

# ELECTRICAL SYSTEM

## Magneto Ignition

On tractors equipped with Recoil Starter, the ignition system is equipped with a magneto to furnish the electrical impulse at the spark plug. See Illust. 24.

### Testing Magneto

1. Check magneto output by placing end of spark plug cable about 1/8 inch from crankcase and the engine. Remove the spark plug to make cranking easier.

2. If there is no spark, check the breaker points.

3. After the breaker points have been cleaned or replaced and there is still no spark, the magneto is at fault.

4. If a good commercial tester is available, components of the magneto can be checked. Refer to tester manufacturer's instructions for acceptance limit of coils.

## Battery Ignition

On tractors equipped with an electric starter, the electrical system consists of a motor-generator, voltage regulator, ignition switch, starting switch, battery, ignition coil and breaker point assembly.

The motor-generator acts as cranking motor when the starter switch is closed and a generator when the switch is open. The voltage regulator controls current and voltage to the battery at all engine speeds. See Illust. 25.

Note: Although lighting attachments are not provided through International Harvester, some owners or operators may obtain lights from other sources and want them installed. In this case the load should not exceed five amperes.

### Motor-Generator

1. The hinge cap oilers should be filled with eight to ten drops of light oil every 100 hours of operation.

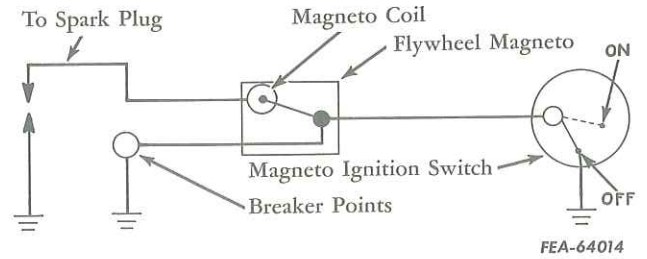

Illust. 24. Schematic wiring diagram of magneto ignition.

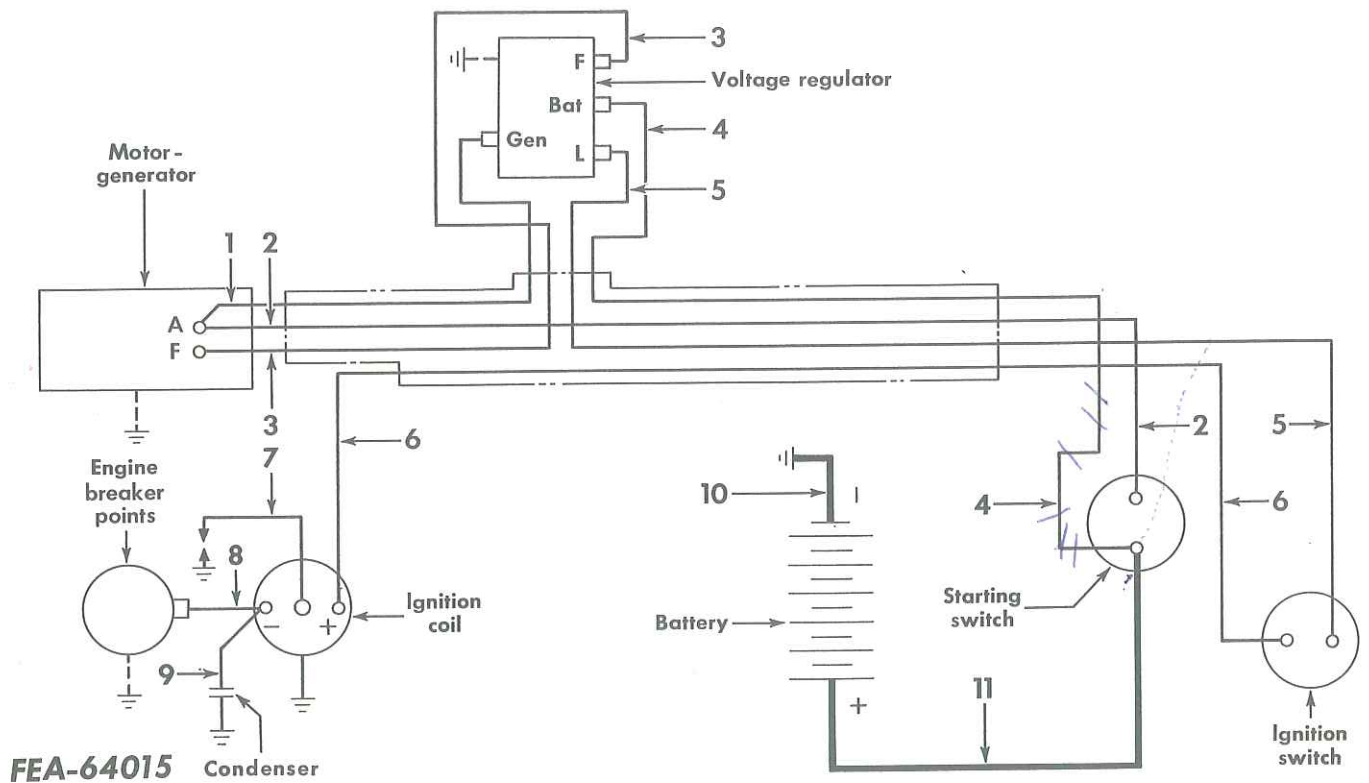

Illust. 25. Schematic wiring diagram of battery ignition.

1. Cable-regulator "GEN" terminal to generator "A" terminal (light blue).
2. Cable-generator "A" terminal to starter button (red).
3. Cable-regulator "F" terminal to generator "F" terminal (yellow).
4. Cable-regulator "BAT" terminal to starter button (gray).
5. Cable-regulator "L" terminal to ignition switch (light green).
6. Cable-ignition coil positive (+) terminal to ignition switch (black).
7. Cable-spark plug to coil (secondary).
8. Cable-breaker points to coil negative (-) terminal.
9. Cable-condenser to coil negative (-) terminal.
10. Cable-battery to ground.
11. Cable-battery to starter button.



2. The brushes should be inspected for wear approximately every 200 hours. If brushes are worn to less than half their original length, they should be replaced. Compare the old brushes with new to determine the amount of wear

3. Brushes can be inspected or replaced by removing the two through bolts and the commutator end frame.

4. After checking or replacing brushes, if the motor-generator still fails to operate satisfactorily the unit will have to be checked further with special testing equipment. Instructions for performing test can be found in literature furnished with test equipment.

### Current-Voltage Regulator

Note: This regulator is the same as used on the 460 and 560 series tractor.

#### CONTACT POINTS

The contact points of a regulator will not operate indefinitely without some attention. A great majority of regulator troubles can be eliminated by a simple cleaning of the contact points and slight adjustments. See Illust. 26. The flat point always develops a slight cavity and is the point that requires the most attention. It is not necessary to have a perfectly flat surface on this point, but cleaning the surface down to pure metal with a fine-cut riffler file will insure

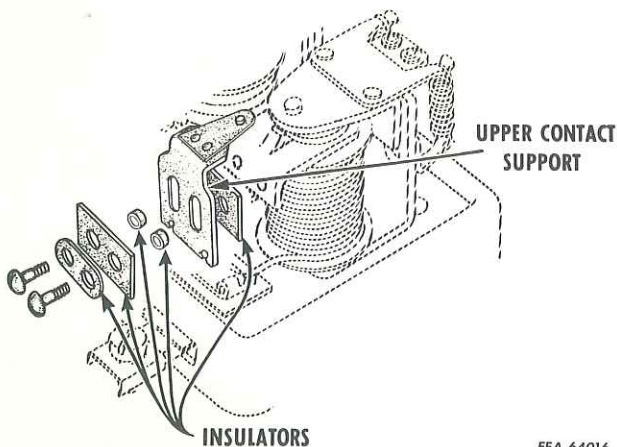

FEA-64016

Illust. 26. Disassembly of upper contact support for cleaning. Use new insulator bushings upon reassembly.

long periods of service without difficulty. The file should not be allowed to become greasy and should not be used to file other metals. After filing, wipe points with lintless cloth saturated in carbon tetrachloride to insure clean surfaces.

Caution: Avoid excessive removal of contact point metal. Never use sandpaper or emery cloth to clean points.

On (-) negative grounded system regulators the flat point is in the armature. Clean them by loosening the upper contact support and moving it to one side.

Note: Regulators are designed for use with a system having a given battery ground polarity. Using the wrong polarity regulator on an installation will shorten the life of the regulator contact points. Be careful to avoid interchanging the two types of regulators in service. Check the parts catalog for the regulator part number when a replacement is necessary.

#### CUT-OUT RELAY ADJUSTMENTS

There are three adjustments of the cut-out relay: Armature to core air gap, contact point opening, and voltage required to close points. The air gap and point opening adjustments must be made with the battery disconnected.

1. Air gap. Place your fingers on the armature directly above the core and press the armature down until the points just close. Then measure the air gap between the armature and the center of the core. See Illust 27. The air gap should be .020 inch. Adjust by raising or lowering the armature at its hinge mounting. Retighten screws after adjustment.

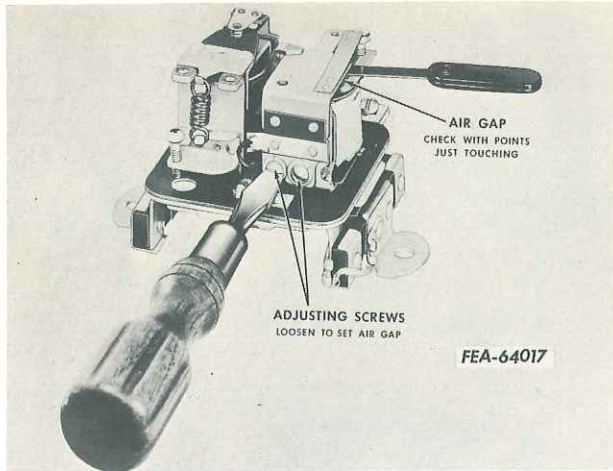

Illust. 27. Cut-out relay air gap inspection and adjustment.

2. Point opening. Adjust the point opening by bending the armature stop as shown in Illust. 28. The opening should be .020 inch.

3. Closing voltage. Adjust the closing voltage by turning the screw clockwise to increase spring tension and voltage, counterclockwise to decrease spring tension and closing voltage. Be sure that closing voltage adjustment is at least 0.5 volt less than the current-voltage regulator unit setting. Refer to the specifications table for range and adjustment. See Illust. 29.

## REGULATOR ADJUSTMENT

The current-voltage regulator unit requires two inspections and adjustments: the armature air gap, and the voltage setting.

1. Regulator air gap. To check the air gap, push the armature down until the contact points are still just touching; then measure the air gap. This should be .075 inch. Adjust by loosening contact mounting screws and raising or lowering the contact bracket as required. Be sure the points are lined up and screws are retightened after adjustment and before retesting the voltage setting. See Illust. 30.

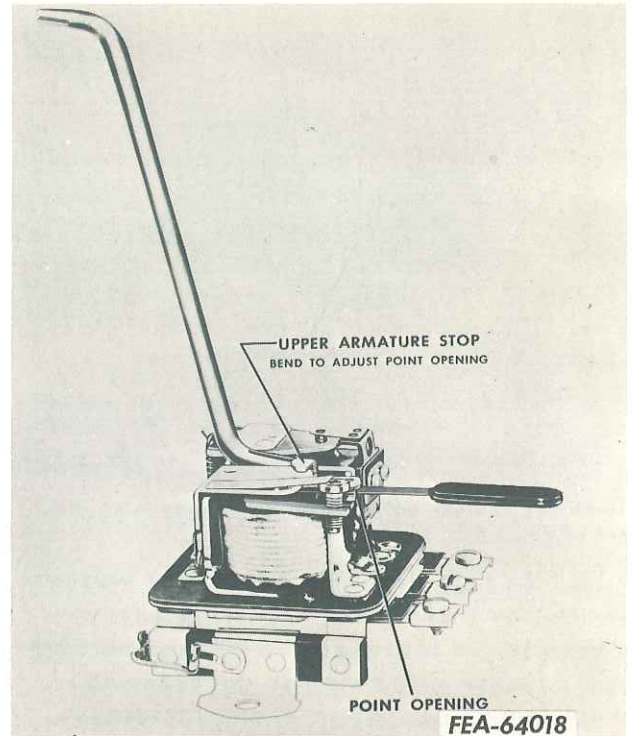

Illust. 28. Cut-out relay point opening inspection and adjustment.

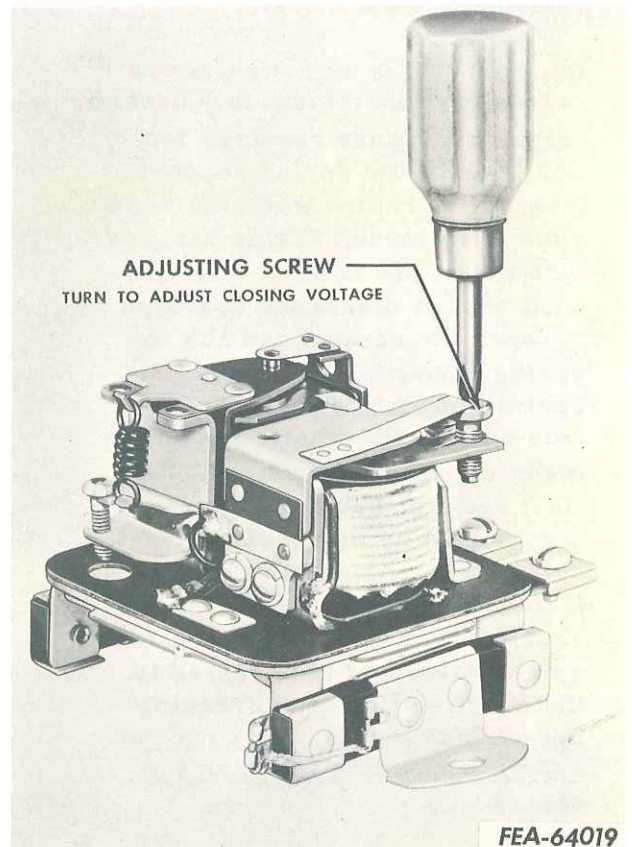

Illust. 29. Adjustment of cut-out relay closing voltage.



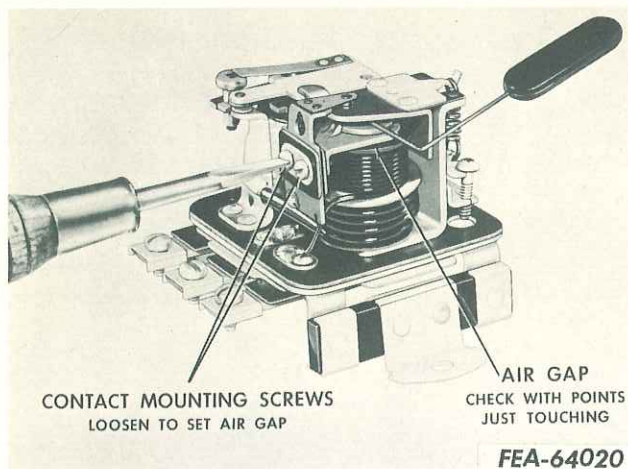

Illust. 30. Current-voltage regulator air gap inspection and adjustment.

2. Voltage setting. Adjust the voltage setting by turning the adjusting screw — clockwise to increase the voltage setting and counter-clockwise to decrease the voltage setting. After each adjustment, replace the cover and allow ample running time to again stabilize voltage and temperature before rechecking the voltage setting. See Illust 31.

Caution: If the adjusting screw is turned down (clockwise) beyond the normal range required for adjustment, the spring support may fail to return when the pressure is relieved. If this happens, turn the screw counter-clockwise until enough clearance develops between the screw head and the spring support. Then bend the spring support upward carefully with small pliers until contact is made with the screw head. The final setting should always be approached by increasing the spring tension. In other words, if the setting is too high, the unit should be adjusted below the required value and then raised to the exact setting by increasing the spring tension. Be sure the screw is exerting force on the hanger.

3. Replacing the regulator spring, when necessary, requires care to pre-

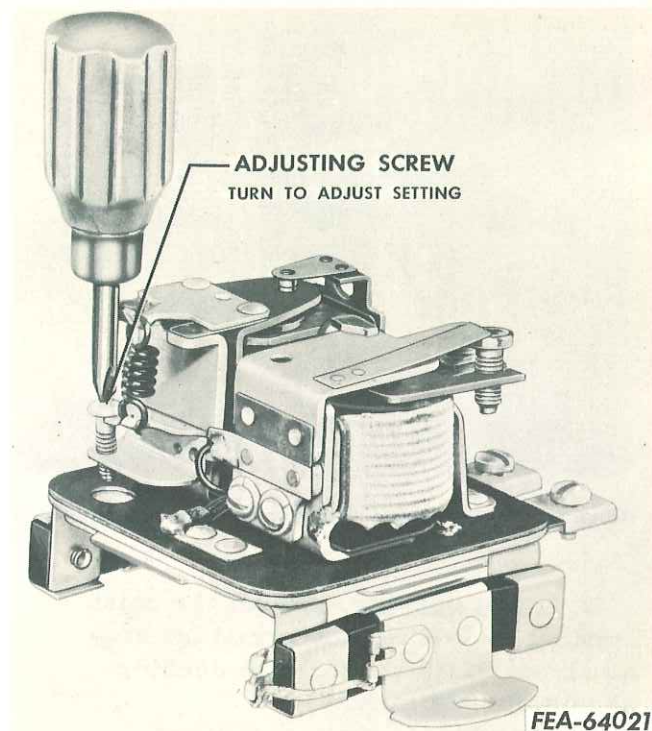

Illust. 31. Adjusting voltage setting, current-voltage regulator unit.

vent bending or distorting the spring support or the armature hinge. Preferably, the spring should be hooked at the lower end first and then stretched up with a screwdriver blade, or other suitable tool, inserted between the turns until the upper end of the spring can be hooked.

Caution: Do not try to pry the upper end of the spring over the armature hook.

4. The resistor, "F" terminal to ground, when open circuited will cause rapid pitting and burning of regulator unit points. The original resistor unit can be removed by use of pliers, and a new unit can be soldered firmly in its place.

5. Ground lead assembly may also be replaced when necessary by soldering a new assembly into place between the regulator base plate and mounting bracket on the rubber shock mounting.

## Ignition Timing

1. The engine is equipped with a timing sight hole in left side of bearing plate, when viewed from the front of the engine. Illust. 32.

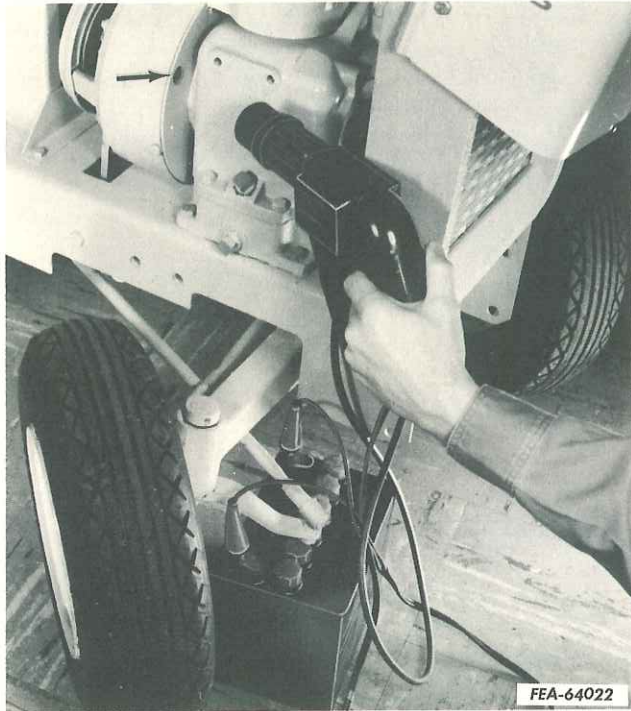

Illust. 32. Checking timing with a timing light. (engine is equipped with recoil starter).

2. For precise ignition timing, rotate flywheel in the direction of normal operation and adjust breaker so that points just begin to break when "DC" or second mark on flywheel appears in the sight hole.

Note: The first or "SP" mark will appear 20 degrees before top dead center. The second mark is top dead center and is stamped with "DC" below the mark.

3. If timing light is available, set breaker point gap while engine is running. Adjust until "SP" or first mark on flywheel is centered in sight hole. Illust. 32.

Note: On tractors equipped with recoil starter an auxiliary battery must be used to operate the timing light.

## Breaker Assembly

1. Breaker points are operated by a cam on engine camshaft.

2. Dirty contact points can be cleaned with gasoline. Wipe dry and make sure that no lint or oil film is left between breaker point surfaces.

3. Pitted or burned points should be replaced. See ignition timing for proper setting.

## Spark Plug

1. Service periodically to reduce fouling. The deposits are hard to remove if allowed to remain longer than 100 operating hours.

2. Degrease wet or oily plug and dry thoroughly.

Caution: If spark plug is sand blasted, make sure all sand is removed by washing in a cleaning solvent and dry with compressed air.

3. File electrode sparking area to obtain bright, flat surfaces.

4. Set gap at .025 inch.

5. Use new gasket when installing new or serviced spark plug. Torque to 27 ft. lbs.

## Testing Condenser

Check condenser with a reliable commercial condenser tester. Replace as necessary.



# RECOIL STARTER

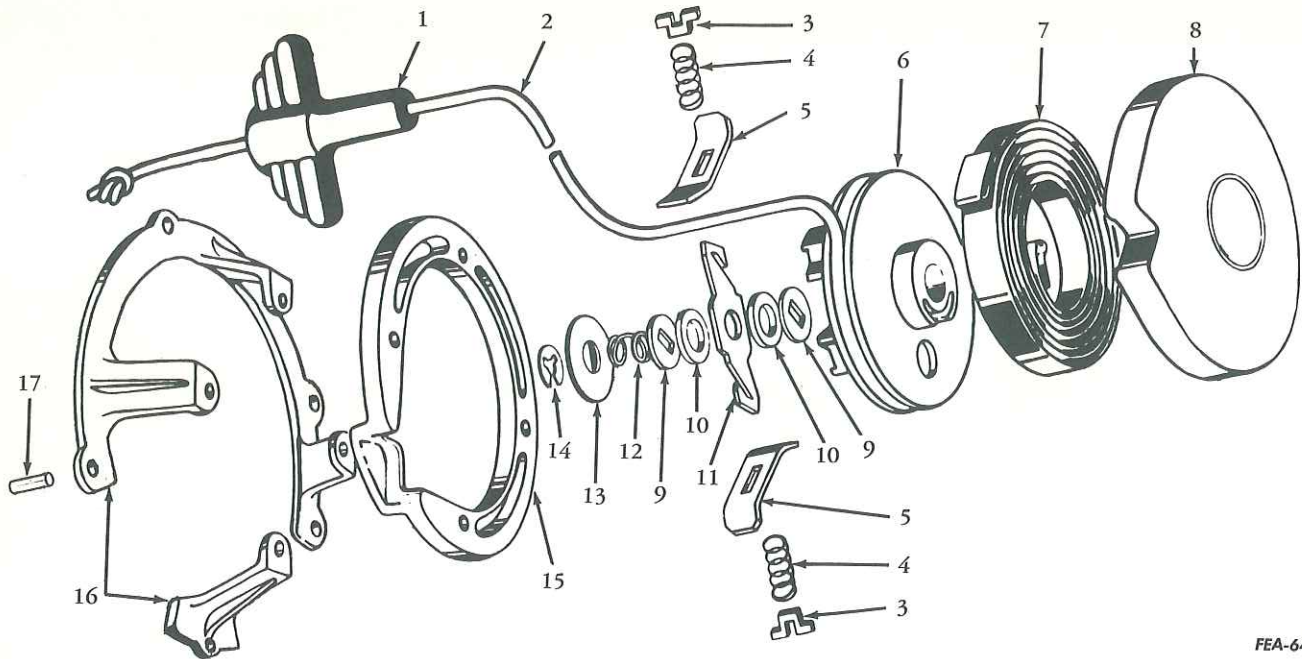

FEA-64023

Illust. 33. Exploded view of recoil starter.

- |                          |                  |                           |
|--------------------------|------------------|---------------------------|
| 1. Handle                | 6. Rotor         | 13. Brake retainer washer |
| 2. Cord                  | 7. Rewind spring | 14. Retainer ring         |
| 3. Spring retainer plate | 8. Cover         | 15. Middle flange         |
| 4. Friction shoe spring  | 9. Brake washer  | 16. Mounting flange       |
| 5. Friction shoe plate   | 10. Fiber washer | 17. Pin                   |
|                          | 11. Brake lever  |                           |
|                          | 12. Brake spring |                           |

This starter is made by Fairbanks-Morse and has a die cast aluminum housing. The starter uses a friction shoe assembly under spring tension to engage in a drive cup when starter is pulled. The flywheel nut holds drive cup in place on the engine. To prevent drive cup slippage, a pin on cup is engaged in flywheel.

## Removal

1. Remove the four cap screws securing the steering pedestal to the frame.
2. Remove the five cap screws securing the starter assembly to the blower

housing. Push the steering pedestal to the rear far enough to remove the starter assembly.

## Disassembly (Refer to Illust.-33)

1. Pull out the centering pin (17); hold the retainer washer (13) with your thumb and with a screw driver remove the retainer ring (14), retainer washer (13), brake spring (12), brake washer (9), fiber washer (10), friction shoe assembly (consisting of 3,4,5 and 11), fiber washer (10) and brake washer (9).

2. If starter cord (2) or rewind spring (7) is to be serviced, remove the four machined screws securing the mounting flange (16), middle flange (15) to the starter cover (8).

Note: Hold the starter handle against the stop on cover plate when removing the mounting flange and middle flange. Raise the handle and remove the preload on the rewind spring slowly.

## Inspection and Reassembly

Inspect all parts for wear or breakage and replace as necessary.

1. To replace the cord, tie a single knot in one end of cord, thread the other end through hole in rotor from engine side facing engine side of rotor, wind cord in a counter-clockwise direction, place the cord through starter handle and tie a double knot in the end of the cord.

2. Place the rewind spring in starter cover so that when you follow the spring from the outside end to the inside end you travel in a counter-clockwise direction.

3. Hook the outside end of the spring over pin in starter cover, place the rotor (6) with cord in cover and hook the inside end of spring to rotor (6).

4. Preload the spring four turns and mount the middle flange (15) and mounting flange (16) to the starter cover (8).

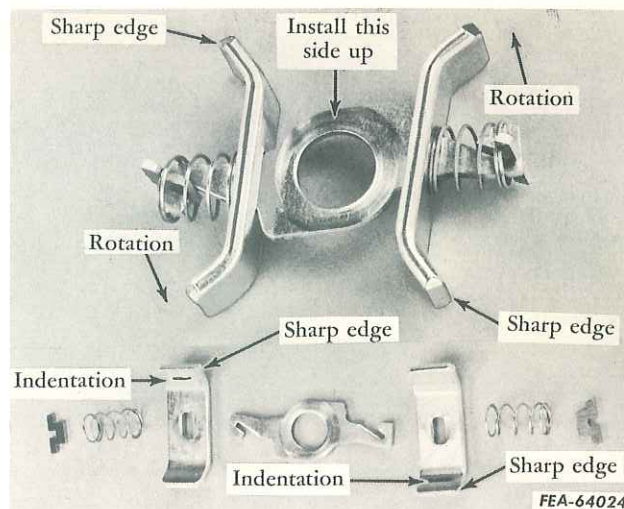

Illust. 34. Exploded and assembled view of friction shoe assembly.

5. Place the brake washer (9), fiber washer (10), friction shoe assembly (including parts (3), (4), (5) and (11), Illust. 34, fiber washer (10), brake washer (9), spring (12), retainer washer (13) and retainer (14) on starter rotor.

Note: If friction shoe assembly was disassembled make sure that the friction shoe plates (5) are placed on brake lever (11) so that the sharp edges (end with indentation) point in the direction against rotation. See Illusts. 34 and 35.

6. Pull the starter cord and if the friction shoe plates (5) do not extend when the cord is pulled invert the friction shoe assembly on rotor.

## Installation on Engine

1. Place centering pin (17, Illust. 33), in end of starter rotor just enough to keep the pin from falling out.



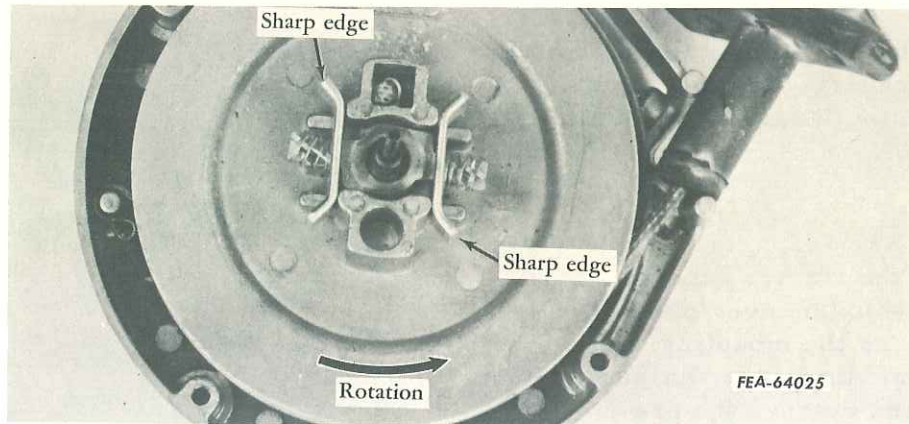

**Illust. 35. View of friction shoe assembly properly placed on rotor.**

2. Place the unit on blower housing with centering pin in end of the crankshaft.

3. Start the five screws that hold the starter assembly to the blower housing, pull the starter cord until the friction

shoe plates (5) Illust. 33 engage in starter cup then tighten the five cap screws.

4. Install the four cap screws securing the steering pedestal to the tractor frame.

# SERVICE BULLETIN RECORD

Important: Information in this manual section is subject to change or supplementing from time to time as a result of field experience and engineering modifications. As Service Bulletins are received, record them on this page for handy reference whenever this manual is to be used. . .Print entries in ink.

| Bulletin<br>No. | Date<br>Issued | Book<br>No. | Topic or part of machine involved. |
|-----------------|----------------|-------------|------------------------------------|
|                 |                |             |                                    |
|                 |                |             |                                    |
|                 |                |             |                                    |
|                 |                |             |                                    |
|                 |                |             |                                    |
|                 |                |             |                                    |
|                 |                |             |                                    |
|                 |                |             |                                    |
|                 |                |             |                                    |
|                 |                |             |                                    |
|                 |                |             |                                    |
|                 |                |             |                                    |
|                 |                |             |                                    |
|                 |                |             |                                    |
|                 |                |             |                                    |
|                 |                |             |                                    |
|                 |                |             |                                    |
|                 |                |             |                                    |
|                 |                |             |                                    |
|                 |                |             |                                    |
|                 |                |             |                                    |
|                 |                |             |                                    |
|                 |                |             |                                    |
|                 |                |             |                                    |
|                 |                |             |                                    |
|                 |                |             |                                    |
|                 |                |             |                                    |





*Accidents  
can strike  
like  
lightning!*



**A SECOND  
IS ALL  
IT TAKES**



**BE CAREFUL** at all times, or  
**YOU** may be next!





**1<sup>st</sup>** in service