



Professional Shop Manual



Z-Force S

NOTE: These materials are for use by trained technicians who are experienced in the service and repair of outdoor power equipment of the kind described in this publication, and are not intended for use by untrained or inexperienced individuals. These materials are intended to provide supplemental information to assist the trained technician. Untrained or inexperienced individuals should seek the assistance of an experienced and trained professional. Read, understand, and follow all instructions and use common sense when working on power equipment. This includes the contents of the product's Operators Manual, supplied with the equipment. No liability can be accepted for any inaccuracies or omission in this publication, although care has been taken to make it as complete and accurate as possible at the time of publication. However, due to the variety of outdoor power equipment and continuing product changes that occur over time, updates will be made to these instructions from time to time. Therefore, it may be necessary to obtain the latest materials before servicing or repairing a product. The company reserves the right to make changes at any time to this publication without prior notice and without incurring an obligation to make such changes to previously published versions. Instructions, photographs and illustrations used in this publication are for reference use only and may not depict actual model and component parts.

© Copyright 2010 MTD Products Inc. All Rights Reserved

MTD Products Inc. - Product Training and Education Department

FORM NUMBER - 769-05513

06/2010

Table of Contents

Chapter 1: Introduction	1
Professional Shop Manual intent	1
Fasteners	1
Assembly	2
Description of the Z-Force-S	2
Model and Serial Numbers	3
Chapter 2: Engine Related Parts	5
Muffler	5
Fuel tank removal/replacement	6
Chapter 3: Brakes	7
Brake system description	7
Brake adjustment	8
Brake puck/rotor replacement	9
Brake shaft assembly	12
Parking brake lever	14
Chapter 4: Body	17
Floor pan	17
Left control console	19
Right control console	23
Seat	26
Seat box assembly	27
Chapter 5: Drive	29
Drive belt	29
Drive belt adjustment	32
EZT transmission removal/replacement	33
ZT 2800 transmission removal/replacement	35
Drive pedal biasing adjustment	38
Hydro neutral control adjustment	39
Chapter 6: Steering	43
Introduction	43
Wheel alignment and drive control link adjustments	43
Steering gear box removal	47
Steering gearbox installation	50
Rebuilding the steering gear box	54
Front wheels	67
Front yokes	69
Removal of the steering gears	71
Tie rods	76
Steering shaft, bushings and dampener removal	79

Chapter 7: Electrical System	87
Introduction	87
RMC Module	87
Key switch	88
RMC Module	90
To identify a faulty RMC module	91
PTO Switch	93
Parking Brake Switch	93
Reverse Safety Switch	94
Seat Safety Switch	94
Starter solenoid	95
PTO Relay	95
Lighting circuit	96
Start Circuit	96
Run Circuit	99
Run Circuit / Reverse Caution mode	100
Engine shut-down circuits	101
Charging circuit	102
PTO Circuit	107
Reverse Mower Control (RMC) circuit operation	109
Electrical diagnosis	111
Electronics	111
Electrical environment: AC Vs. DC	112
Ohm's Law	113
Kirchhoff's current law	113
Kirchhoff's voltage law	114
How the system is wired together	114
Types of circuits	115
Series	115
Parallel	115
Series/parallel	116
Shorts	116
Opens	116
Increased resistance	116
The Tools	117
Digital Multi-meter	118
Wiring diagram or schematic	119
Fused jumper wires	119
Test lights	119
Self-powered continuity lights	119
Ammeters and specialized charging system testers	120
Batteries	121
Charging the battery	121
Checking battery condition	122
Battery Testers	123
Adjustable load testers	123

Fixed load testers	124
Conductance testers	124
Battery discharge test	125
Storage of batteries	125
Electrical Troubleshooting	126
Voltage Drop Test	128
Testing switches	131
Diodes	132
Relay	134
Schematic	135
Chapter 8: Decks And Lift Shaft	137
Cutting decks	137
Cleaning the deck	138
To clean the deck while it is removed	138
Blades	139
PTO belt	141
Deck Belt	142
Belt tension	143
Spindle pulleys and spindle shafts	144
Spindle removal/installation	145
Spindle overhaul	146
Leveling the deck	148
Side to Side Leveling	148
Front To Rear (pitch) Leveling	149
Deck Gauge Wheel Adjustment	150
Front and rear deck lift shaft assembly	151
Deck lift pedal lever	153
Chapter 9: Maintenance Intervals	155
Lubrication	155
Engine maintenance	155
The spark plugs	156
Air filter.	157
Oil change	158
Oil filter.	159
Fuel system	160
Servicing the fuel system	160
Fuel filter	160
Clean the engine	161
Transmissions	161

CHAPTER 1: INTRODUCTION

Professional Shop Manual intent

This Manual is intended to provide service dealers with an introduction to the mechanical aspects of the Z-Force-S riding mower.

- Detailed service information about the engine will be provided by the engine manufacturer, in most cases.

Disclaimer: The information contained in this manual is correct at the time of writing. Both the product and the information about the product are subject to change without notice.

About the text format:

NOTE: is used to point out information that is relevant to the procedure, but does not fit as a step in the procedure.

- Bullet points: indicate sub-steps or points.



Caution is used to point out potential danger to the technician, operator, bystanders, or surrounding property.



Warning indicates a potentially hazardous situation that, if not avoided, could result in death or serious injury.



Danger indicates an imminently hazardous situation that, if not avoided, will result in death or serious injury. This signal word is to be limited to the most extreme situations

Disclaimer: This manual is intended for use by trained, professional technicians.

- Common sense in operation and safety is assumed.
- In no event shall MTD or Cub Cadet be liable for poor text interpretation or poor execution of the procedures described in the text.
- If the person using this manual is uncomfortable with any procedures they encounter, they should seek the help of a qualified technician or Cub Cadet Technical Support.

Fasteners

- Most of the fasteners used on these mowers are sized in fractional inches. The engine and transmissions are metric. For this reason, wrench sizes are frequently identified in the text, and measurements are given in U.S. and metric scales.
- If a fastener has a locking feature that has worn, replace the fastener or apply a small amount of releasable thread locking compound such as Loctite® 242 (blue).
- Some fasteners like cotter pins are single-use items that are not to be reused. Other fasteners such as lock washers, retaining rings, and internal cotter pins (hairpin clips) may be reused if they do not show signs of wear or damage. This manual leaves that decision to the judgement of the technician.

Z-Force-S

Assembly

Torque specifications may be noted in the part of the text that covers assembly, they may also be summarized in tables along with special instructions regarding locking or lubrication. Whichever method is more appropriate will be used. In many cases, both will be used so that the manual is handy as a quick-reference guide as well as a step-by-step procedure guide that does not require the user to hunt for information.

The level of assembly instructions provided will be determined by the complexity and of reassembly, and by the potential for unsafe conditions to arise from mistakes made in assembly.

Some instructions may refer to other parts of the manual for subsidiary procedures. This avoids repeating the same procedure two or three times in the manual.

Description of the Z-Force-S

The Z-Force-S combines a traditional Z-force lap bar zero turn rider (ZTR) with Cub Cadet's patented Syncro Steer™ technology.

The magic of the system: variable ratio steering gears that turn the front wheels much further than conventional systems. The steering control is linked to the traction drive system control.

The traction drive system synchronizes the steering angle of the front tires with the speed and direction of the rear tires.

A true zero-turn is achieved when the operator turns the steering wheel far enough that the inside rear wheel spins in reverse just like a traditional lap-bar controlled ZTR.



Figure 1.1

Model and Serial Numbers



Figure 1.2

The model and serial number tag can be found under the seat. See Figure 1.2.

The serial number is located to the right of the model number as shown above. See Figure 1.2.

The model number is 17AI5BHB010. The break down of what the number mean is as follows:

- 1Residential machine
- ...7Residential zero turn mower
-A.....Sales level
-I.....Engine code
-5.....Frame
-B.....Transmission (B = EZT, G = ZT2800)
-HStyle series
-B.....Deck (B = 48", D = 60")
-010Customer number

The serial number is 0J149Z20021. The serial number reads as follows:

- 0Engineering level
- ..JMonth of production (J = October)
-14.....Day of the month
-9Last digit of the year
-Z.....Plant it was built in (Streetsboro, OH)
-2Assembly line number
-0005Number of unit built

CHAPTER 2: ENGINE RELATED PARTS

This chapter will cover the engine accessories that are manufactured by Cub Cadet.

IMPORTANT: The engine is manufactured by Kawasaki. Refer to the Kawasaki manual for engine specific service information.

Muffler

Remove the muffler by following these steps:

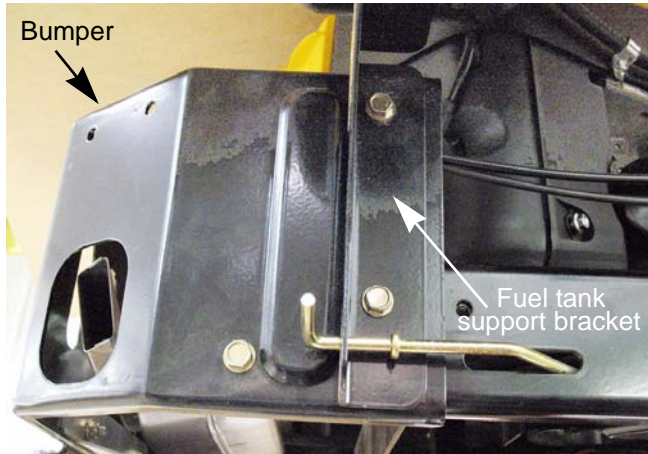

Figure 2.1

1. Remove the six nuts and bolts (three on each side) that hold the rear bumper in place using a pair of 1/2" wrenches. See Figure 2.1.
2. Slide the bumper out from between the frame, the fuel tank bracket on the right and utility bin bracket on the left.

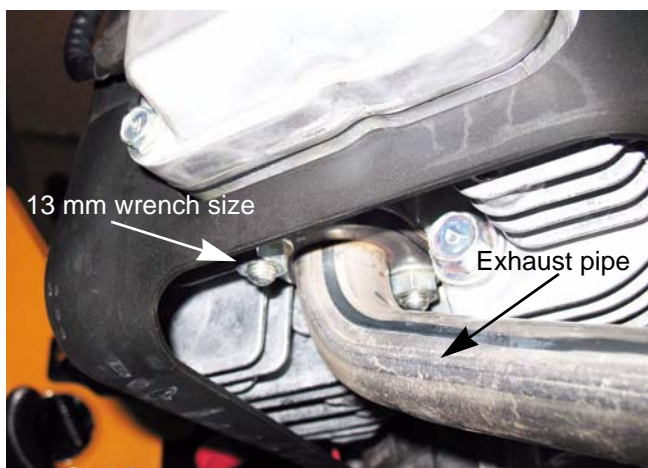

Figure 2.2

3. Remove the two nuts that hold each exhaust pipe to the cylinder head using a 13 mm wrench. See Figure 2.2.

4. Remove the muffler and exhaust pipes.

NOTE: The exhaust pipes are welded to the muffler. The pipes and the muffler are serviced as one assembly.

5. Clean and remove all gasket material from the cylinder head (and the exhaust pipe if they are being reused).
6. Using new gaskets, install the muffler by following the previous steps in reverse order.

NOTE: Tighten the exhaust nuts to a torque of 120 ft lbs (14Nm).

NOTE: When installing the bumper, insert all six bolts before tightening them. Otherwise the bumper will bind and the holes will not line up.

7. Test drive the mower in a safe area before returning it to service.

Z-Force-S

Fuel tank removal/replacement

Remove/replace the fuel tank by following these steps:



Gasoline and its vapors are extremely flammable. Use common sense when working around the fuel system

1. Clamp off the fuel line between the fuel tank and the fuel filter.
2. Disconnect the fuel line from the fuel tank at the fuel filter.
3. Drain the fuel into an approved container.



Figure 2.3

4. Remove the fuel tank by removing the four screws that hold it to the support brackets using a 9/16" wrench. See Figure 2.4.
5. Install the fuel tank by following the previous steps in reverse order.
6. Test drive the mower in a safe area before returning it to service.

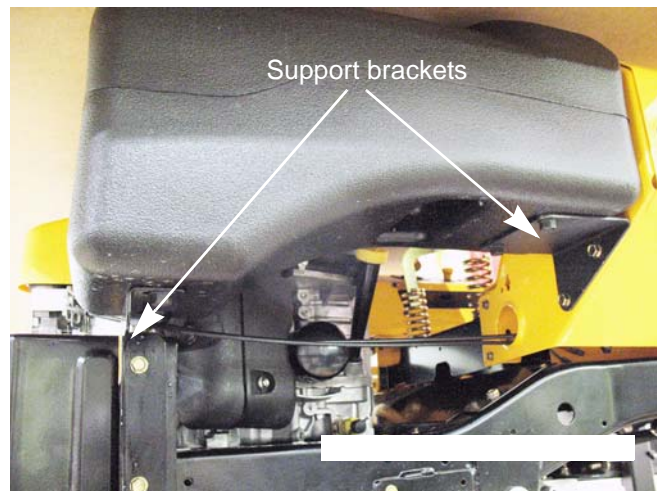

Figure 2.4

CHAPTER 3: BRAKES

Brake system description

The Z-Force-S uses twin HydroGear transmissions to drive the rear wheels. The hydraulic action of the transmissions will provide the braking for the mower while it is in motion. There is a friction brake on the transmission, but it is used as a parking brake.

NOTE: Mowers equipped with a 48" deck have HydroGear EZT transmissions with the brakes on the inboard side of the transmissions (shown below). Mowers with the 60" deck are equipped with HydroGear ZT2800 transmissions. The brakes for the ZT2800 transmissions are mounted to the frame of the mower on the outboard side of the transmissions. The brakes for both the EZT and the ZT2800 transmissions function and are serviced the same way.

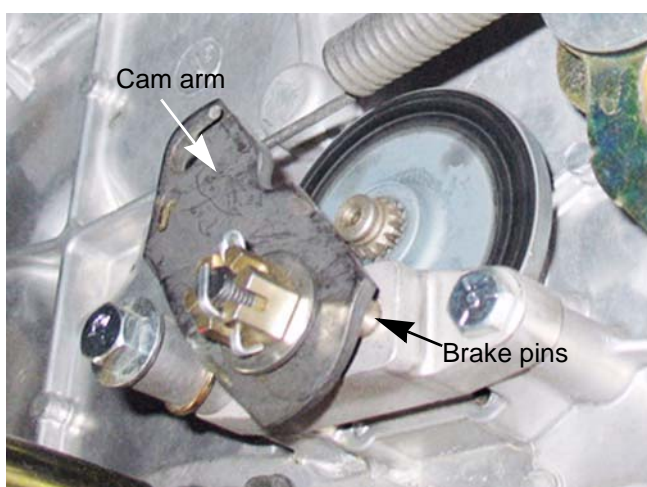

Figure 3.1

- There is a brake for each transmission.
- They are activated by moving the parking brake lever to the "ON" position.
- The parking brake lever operates the brake shaft.
- The brake shaft has three bell cranks. The two outer bell cranks are for applying the brakes. They are connected to the brake caliper cam arms by extension springs.
- When the cam arms are pulled forward, they push on the brake pins with a cam action applying pressure to the brake pads. See Figure 3.1.

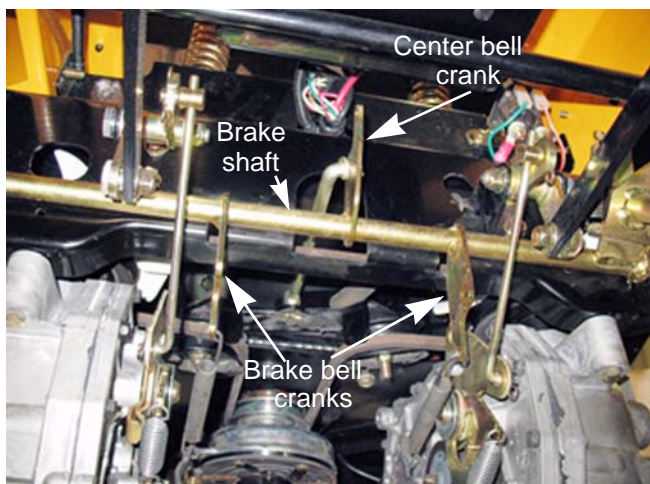

Figure 3.2

- The center bell crank on the brake cross shaft assembly has a link that is connected to the drive belt idler pulley bracket. When the parking brakes are applied, the idler pulleys are pulled away from the drive belt. This de-tensions the belt, disengaging drive to the transmissions. See Figure 3.2. The adjustment procedure for the brake link is covered in the drive belt adjustment section of Chapter 5: Drive.

Z-Force-S

Brake adjustment

NOTE: When performing a brake adjustment, inspect the brake components for signs of wear or damage.

1. Block the front wheels.
2. Lift and safely support the rear of the mower.
NOTE: Make sure the parking brake is released.
3. Remove the cotter pin locking the castle nut on the brake caliper. See Figure 3.3.
4. Back the castle nut off a few turns using a 9/16" wrench.

NOTE: Even if the brakes are set to the correct clearance, inserting a feeler gauge between the rotor and the brake puck can be very difficult. Loosen the castle nut first, then insert the feeler gauge and tighten the nut to set the proper clearances



Figure 3.3

5. Insert a 0.030" (0.8 mm) feeler gauge between the brake rotor and the outboard brake puck. See Figure 3.4.

NOTE: The tolerance for the brake clearance is 0.020" - 0.040" (0.5 - 1.0mm). The 0.030" feeler gauge will set the clearance at the midpoint.

6. Tighten the nut until there is slight drag on the feeler gauge.

NOTE: For even braking, both sides should be set to the same clearance.

7. Install a new cotter pin.
8. Repeat same procedure on the other side.
9. Take the mower off of the jack stands.
10. Open the by-pass valves and check the parking brake before returning the mower to service.
 - With the brakes released, the mower should have only hydraulic drag when it is pushed.
 - With the brakes engaged, the wheels should slide before they rotate when the mower is pushed.
11. Test drive the mower in a safe area before returning it to service.



Figure 3.4

Brake puck/rotor replacement

On HydroGear transmissions, the brake pucks are wearing parts that will need to be serviced from time to time. If a mower is operated with the parking brake dragging, the pucks will wear out rapidly and the brake rotor will develop hot spots. If the mower is operated long enough, the rotor may have grinding marks on it with excessively worn pucks.



If the rotor shows hot spots or any other signs of damage, including warpage, it must be replaced. Failure to do so can result in the failure of the brakes

The brake pucks and the rotors are serviced at the same time. To service the brake pucks:



Figure 3.5

1. Lift and safely support the rear of the mower.
2. Make sure the parking brake is released.
3. Disconnect the brake springs. See Figure 3.5.

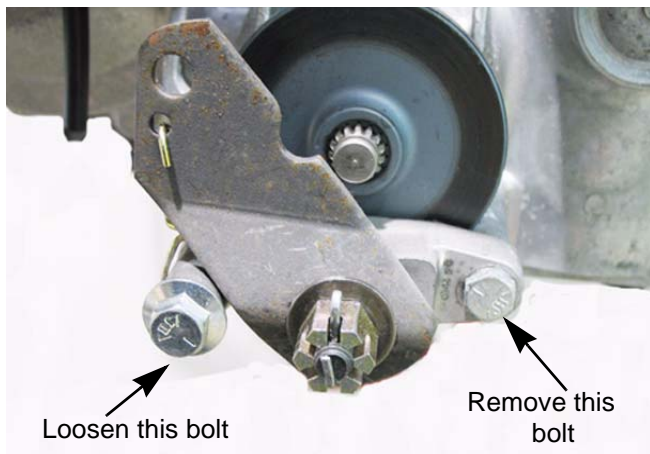

Figure 3.6

4. Loosen the rear mounting bolt. See Figure 3.6.

Z-Force-S

5. Remove the front mounting bolt, allowing the caliper to swing down. See Figure 3.7.
6. The outboard brake puck should fall out when the brake caliper swings down. If it did not, it can be removed now.

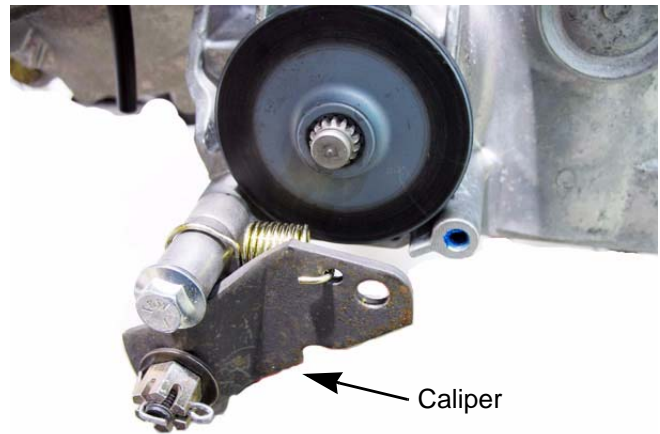

Figure 3.7

7. Slide the brake rotor off to reach the inboard brake puck. See Figure 3.8.
8. Remove the caliper for inspection when servicing the brake pucks. To do this, remove the rear bolt loosened in step 4.

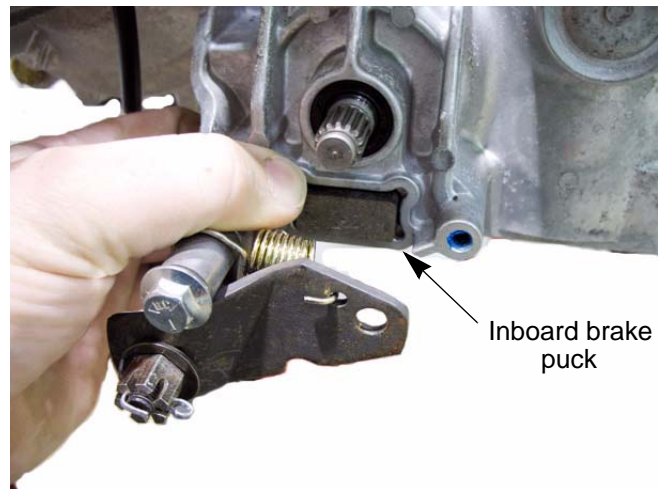



Figure 3.8

9. With the caliper on a work bench, remove the brake puck, backing plate and the two brake pins. See Figure 3.9.
10. Check for free movement of the brake pins. A dry lubricant can be used on the brake pins sparingly.

	CAUTION Never put grease or anti-seize on brake pins. It can migrate to the brake pucks, preventing the braking action of the pucks.
---	---

11. Slide the brake pins into the caliper.
12. Place the backing plate in the caliper.

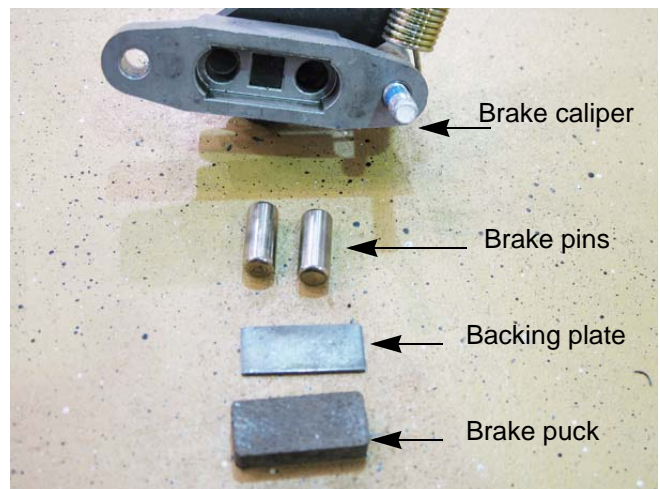

Figure 3.9

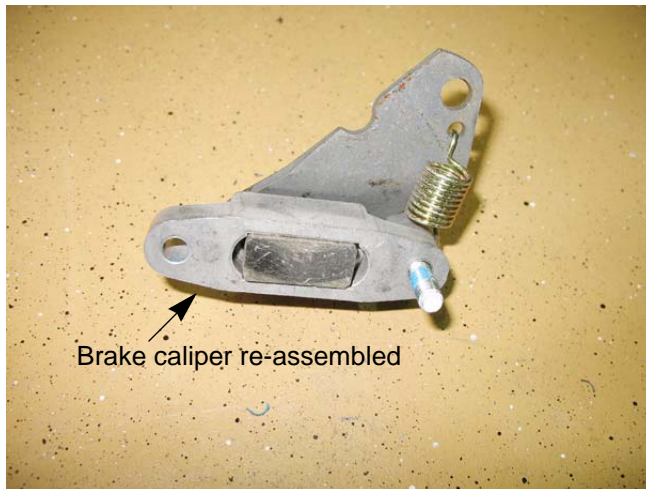

Figure 3.10

13. Place a new puck into the caliper. See Figure 3.10.
- NOTE:** A piece of scotch tape may be used to hold the new brake pucks in place for assembly. The tape will grind away when the brakes are applied.
14. Place a new brake puck into the recess in the transmission. Use a piece of scotch tape to hold it in place.
 15. Slide the brake rotor in place, shoulder out.
 16. Mount the brake caliper to the transmission. Apply a small amount of releasable thread locking compound such as Loctite® 242 (blue) to the mounting bolts and tighten to a torque of 80 - 120 in-lbs (9 - 13.5Nm).
 17. Reconnect the brake spring.
 18. Adjust the brakes as described in the previous section of this chapter.
19. Repeat steps 4-19 on the other side.
 20. When both sides are completed, take the mower off of the jack stands.
 21. Open the by-pass valves and check the parking brake before returning the mower to service.
 - With the brakes released, the mower should have only hydraulic drag when it is pushed.
 - With the brakes engaged, the wheels should slide before they rotate when the mower is pushed.
 22. Test drive the mower in a safe area before returning it to service.

Z-Force-S

Brake shaft assembly

To remove/replace the brake shaft:

1. Remove the cutting deck by following the procedures described in Chapter 8: Cutting Decks and Lift shaft.
2. Lift and safely support the rear of the mower.
3. If the parking brake is set, release it.
4. Disconnect the brake springs. See Figure 3.11.
5. Disconnect the link that runs from the idler bracket to the brake shaft by removing the cotter pin. See Figure 3.12.
6. Disconnect the adjustable drive links from the pivot arms by removing the bow tie clips at the ferrule end of the link. See Figure 3.13.

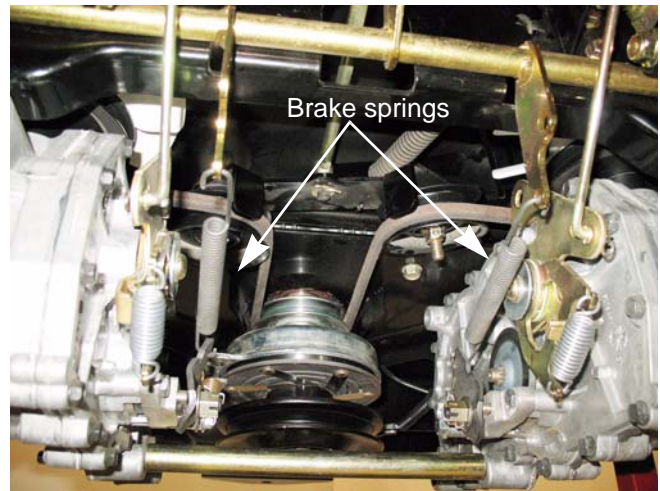

Figure 3.11

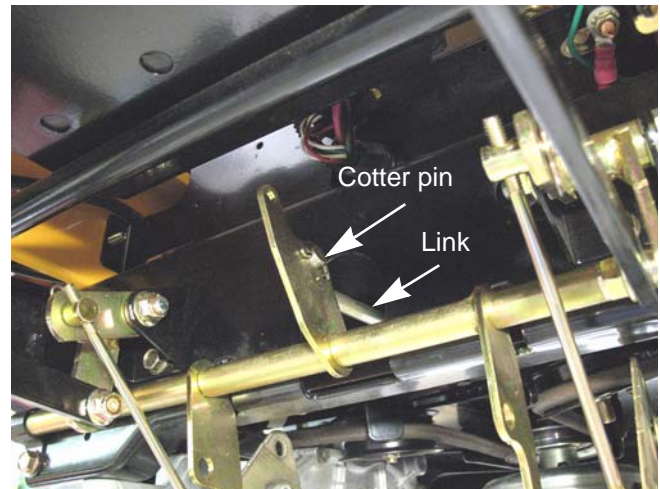

Figure 3.12

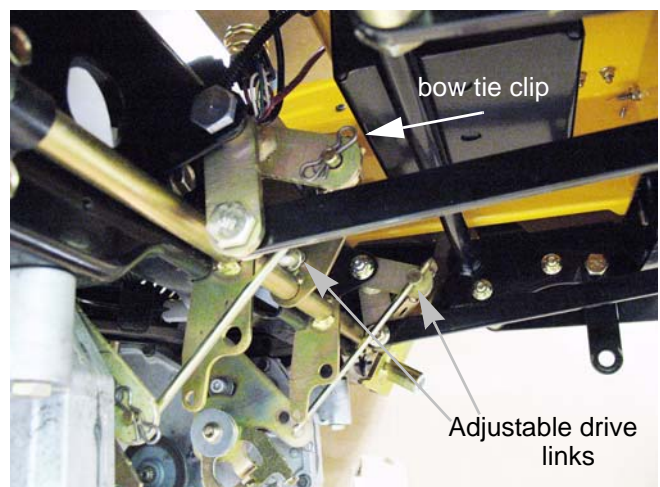

Figure 3.13

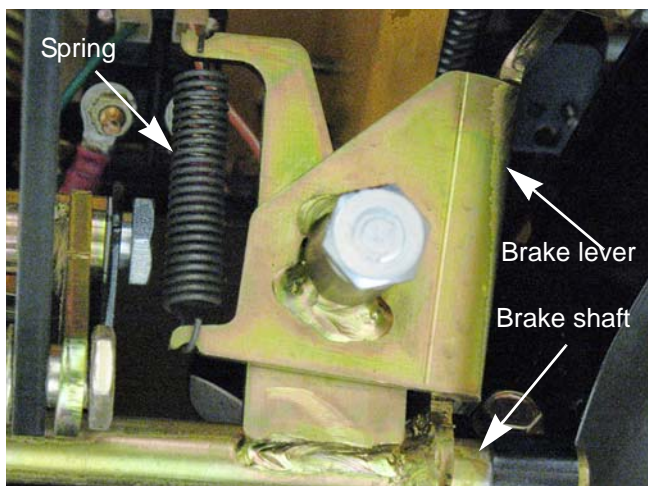

Figure 3.14

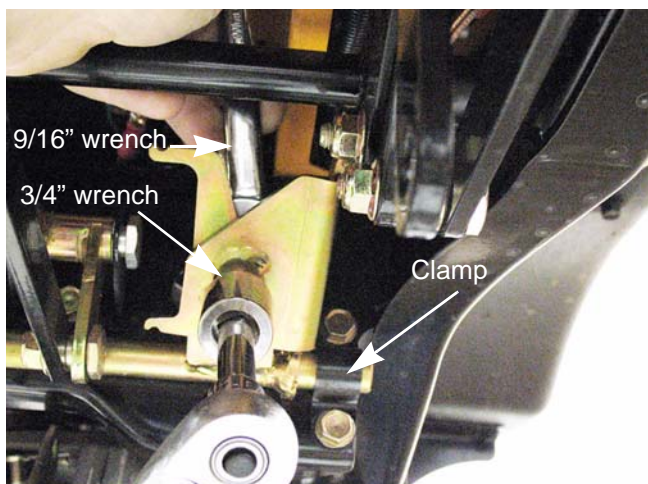

Figure 3.15

7. Remove the extension spring that runs from the brake lever to the brake shaft. See Figure 3.14.

8. Remove the nut and shoulder bolt that attaches the brake lever to the brake shaft using a 9/16" wrench and a 3/4" wrench. See Figure 3.15.
9. Remove the clamps (one on each side) that hold the brake shaft to the frame of the mower. Use a 1/2" wrench.
10. Install the brake shaft by following the previous steps in reverse order.
11. Test drive the mower in a safe area before returning it to service.

Z-Force-S

Parking brake lever

To remove/replace the parking brake lever:

1. Remove the cutting deck by following the procedures described in Chapter 8: Cutting Decks and Lift shaft.
2. Move the parking brake lever to the "OFF" position.
3. Remove the extension spring that runs from the brake lever to the brake shaft. See Figure 3.16.

NOTE: When the parking brake lever is in the "ON" position, this spring pulls on the lever applying pressure to the parking brake switch.

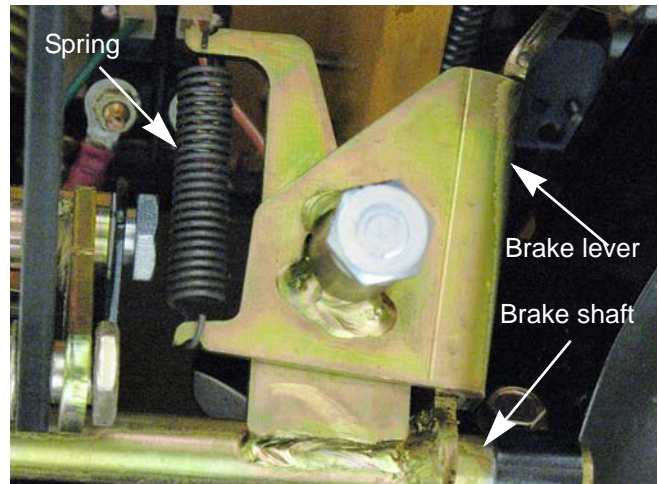

Figure 3.16

4. Remove the two screws from the underside of the left control panel using a T-30 torx driver. See Figure 3.17.

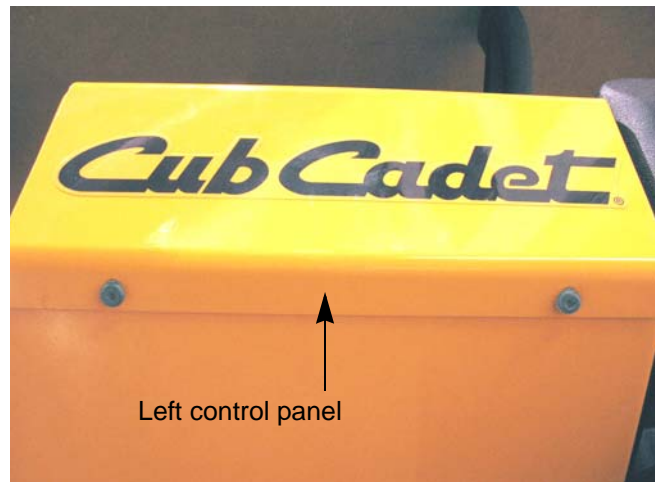

Figure 3.17

5. Remove the grip from the parking brake lever. See Figure 3.18.
6. Remove the two screws that hold the left control panel to the seat box assembly using a T-30 torx driver. See Figure 3.18.
7. Remove the two screws that hold the control panel to the control pods using a T-30 torx driver.



Figure 3.18



Figure 3.19

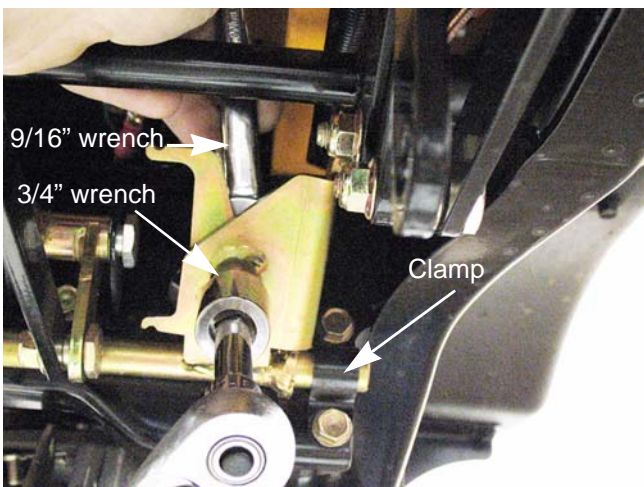

Figure 3.20

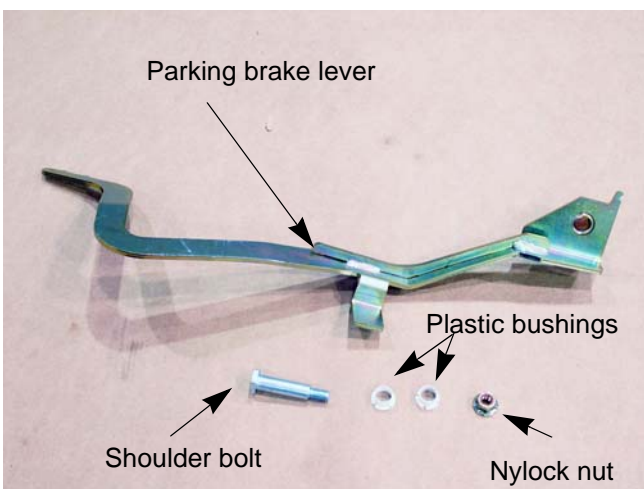

Figure 3.21

8. Carefully raise the control panel enough to gain access to the inside of the control pod.
9. Disconnect the spring that runs from the parking brake lever to the frame of the mower. See Figure 3.19.
10. Remove the nut and shoulder bolt that attach the brake lever to the brake shaft using a 9/16" wrench and a 3/4" wrench. See Figure 3.20.
11. Remove the parking brake lever.
12. Remove and inspect the plastic bushings for signs of wear or damage.
NOTE: If there are signs of damage or wear, replace the bushings.
13. Install the parking brake lever by following the previous steps in reverse order.
14. Test drive the mower in a safe area before returning it to service.

CHAPTER 4: BODY

Floor pan

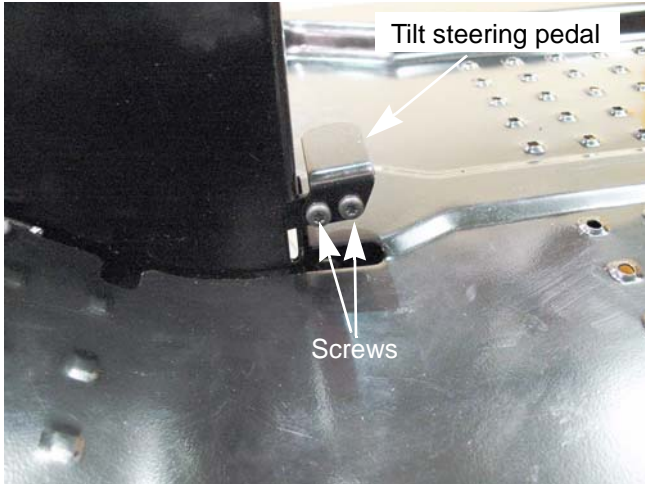

Figure 4.1

To remove/replace the floor pan:

1. Remove the deck by following the procedures described in Chapter 8: Decks and Lift Shafts.
2. Remove the two screws that hold the tilt steering pedal using a T-30 torx driver. See Figure 4.1.
3. Remove the tilt steering pedal.

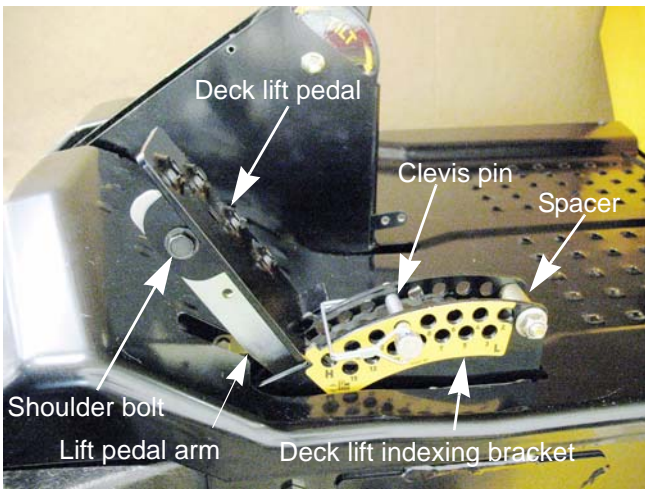

Figure 4.2

4. Remove the rear nut, bolt and spacer from the deck lift indexing bracket using a pair of 9/16" wrenches. See Figure 4.2.
5. Remove the clevis pin from the deck lift indexing bracket. See Figure 4.2.
6. Lower the deck lift pedal.
7. Remove the pedal by removing the shoulder bolt and nut using a pair of 9/16" wrenches.

NOTE: On mowers equipped with a 60" deck, there are two lift assist springs. With the deck removed, these springs will hold the lift pedal arm in the forward position with great force.

Z-Force-S

8. Remove the reverse pedal using a 7/16" wrench. See Figure 4.3.
9. Remove the drive pedal using a 1/2" wrench. See Figure 4.3.

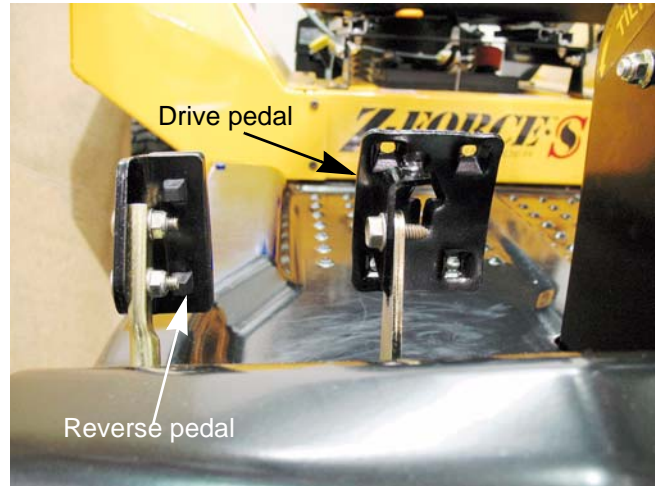

Figure 4.3

10. Remove the eight screws that hold the floor pan to the frame using a T-30 torx driver. See Figure 4.4.
NOTE: The two outboard screws next to the seat box are longer than the rest. They also pass through a pair of spacers.
11. Lift the floor pan off of the mower.

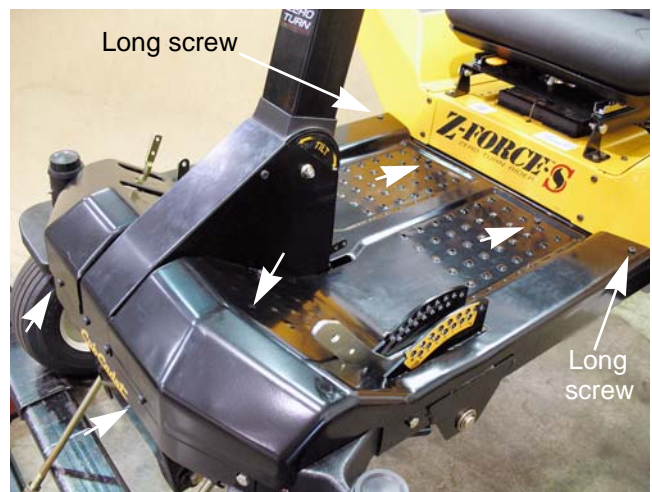

Figure 4.4

NOTE: Under the floor pan there are two spacers. See Figure 4.5.

12. Install the floor pan by following the previous steps in reverse order.



Figure 4.5

Left control console

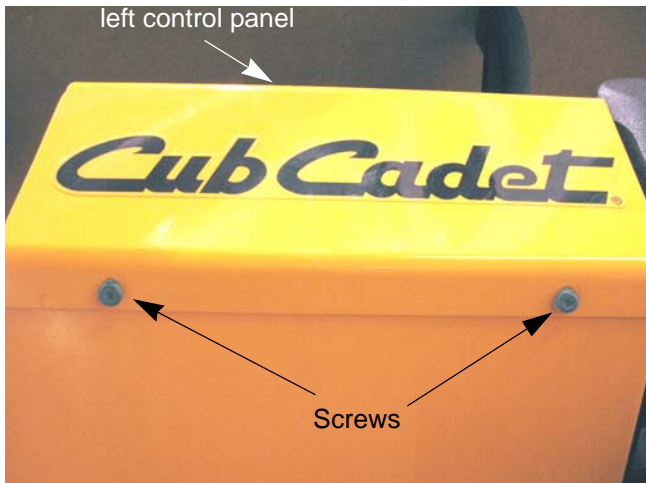



Figure 4.6

To remove/replace the left side control console:

1. Disconnect the negative battery cable.
2. Remove the deck by following the procedures described in Chapter 8: Decks and Lift Shafts.

 CAUTION	Release the parking brake before the control panel.
---	---

3. Remove the two screws from the underside of the left control panel using a T-30 torx driver. See Figure 4.6.

NOTE: Technicians with good dexterity can remove the RMC module, PTO switch and hour meter with out removing the left control panel.

- Release the parking brake
- Remove the four screws that hold the park brake locking plate to the control panel.
- Gentle lower the locking bracket to prevent damage to the parking brake switch.
- Reach into the opening to access the switches.

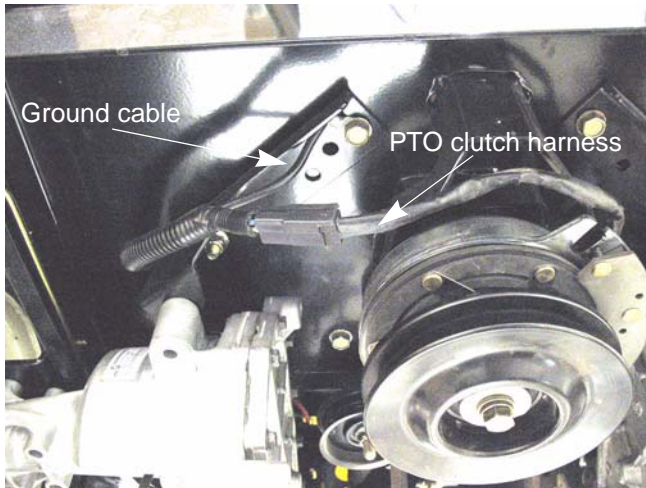

Figure 4.7

4. Disconnect the PTO clutch harness. See Figure 4.7.
5. Disconnect the ground cable from the frame. See Figure 4.7.

Z-Force-S

6. Disconnect the engine harness from the main harness. See Figure 4.8.
7. Disconnect the starter cable. See Figure 4.8.

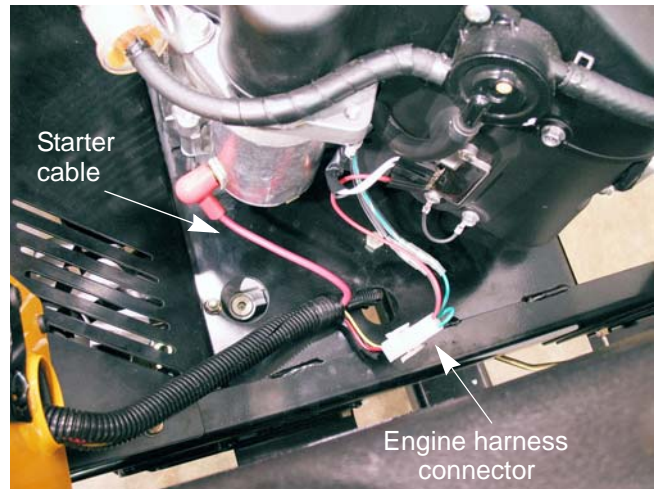

Figure 4.8

8. Remove the grip from the parking brake lever. See Figure 4.9.
9. Remove the two screws that hold the left control panel to the seat box assembly using a T-30 torx driver. See Figure 4.9.
10. Remove the two screws that hold the control panel to the control consoles using a T-30 torx driver.



Figure 4.9

11. Carefully lift up on the control panel to gain access to the wiring under it.
12. Disconnect the wiring harness from the switches and modules. See Figure 4.10.
13. Lift the control panel off of the mower.

NOTE: If the control panel is being replaced, remove the switches and modules from it and install them on the new control panel.

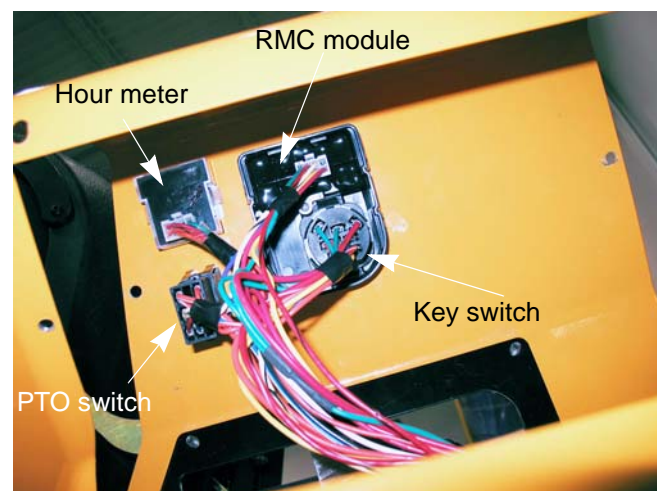

Figure 4.10



Figure 4.11

14. Disconnect the deck lift assist spring. See Figure 4.11.

NOTE: The lift assist spring exerts a lot of force.

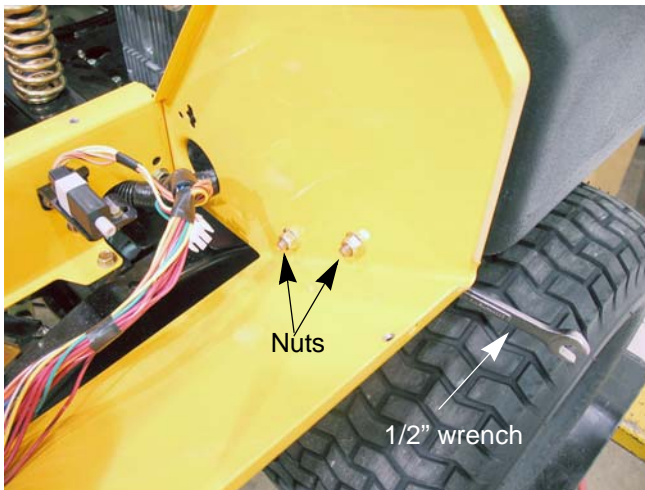

Figure 4.12

15. Remove the nuts and bolts that hold the utility bin bracket to the control console using a pair of 1/2" wrenches. See Figure 4.12.

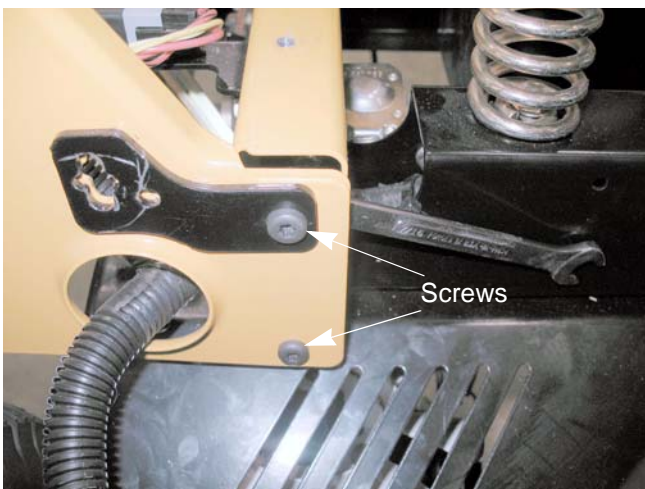

Figure 4.13

16. Remove the two screws that hold the rear of the control console to the seat box assembly using a T-30 torx driver and a 7/16" wrench. See Figure 4.13.

NOTE: The upper screw goes through a reinforcement plate for the lift assist spring.

Z-Force-S

17. Remove the screws that hold the front of the control console to the front of the seat box assembly using a T-30 torx driver and a 7/16" wrench. See Figure 4.21.
18. Gently pull the harness through the hole in the console while lifting it off of the mower.
19. Install the control console by following the previous steps in reverse order.
20. Test drive the mower in a safe area before returning it to service.

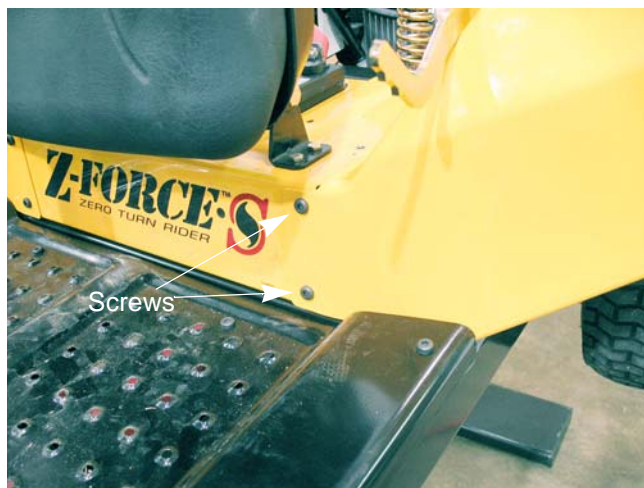

Figure 4.14

Right control console

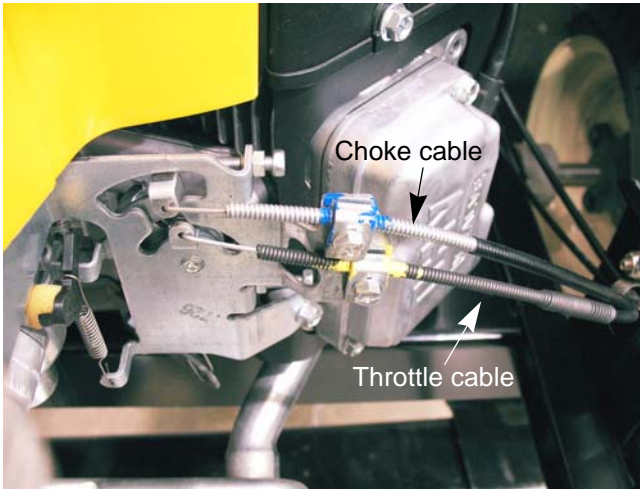

Figure 4.15

To remove/replace the right side control console:

1. Disconnect the choke and throttle cables from the engine. See Figure 4.15.

NOTE: Paint marking and color coding the cables will make reassembly easier.

NOTE: On mowers equipped with the 60" decks, remove the deck by following the procedures described in Chapter 8: Decks and Lift Shafts.

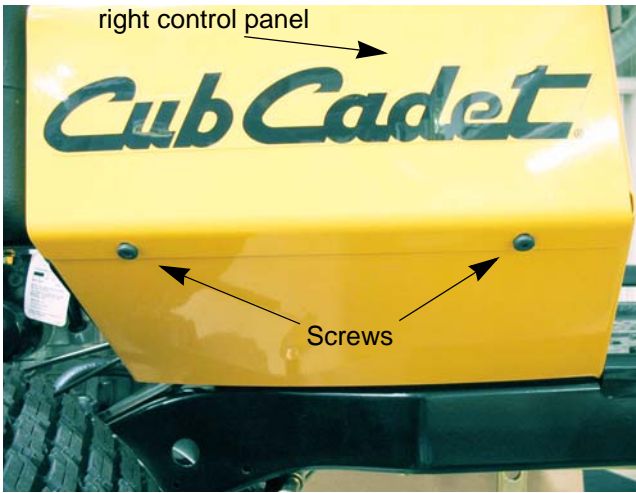

Figure 4.16

2. Remove the two screws from the underside of the right control panel using a T-30 torx driver. See Figure 4.16.

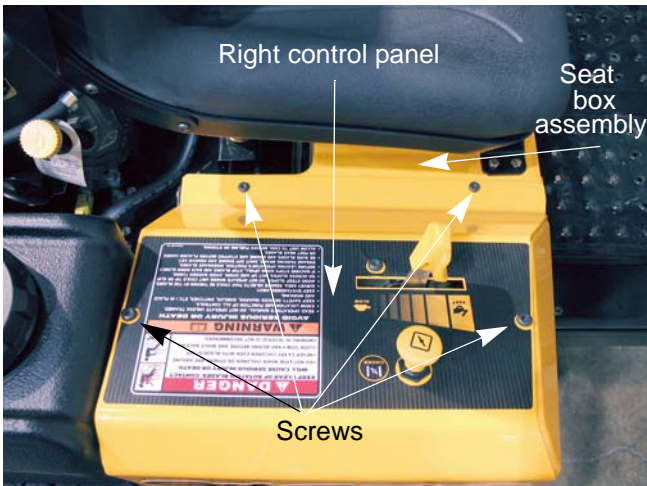

Figure 4.17

3. Remove the two screws that hold the right control panel to the seat box assembly using a T-30 torx driver. See Figure 4.17.

4. Remove the two screws that hold the control panel to the control consoles using a T-30 torx driver.

5. Lift the control panel off of the control console.

NOTE: If the control panel is being replaced, remove the throttle and choke cables from it and install them on the new control panel.

Z-Force-S

NOTE: On mowers equipped with a 60" deck, disconnect the deck lift assist spring.



Figure 4.18

6. Remove the nuts and bolts that hold the fuel tank bracket to the control console using a pair of 1/2" wrenches. See Figure 4.19.

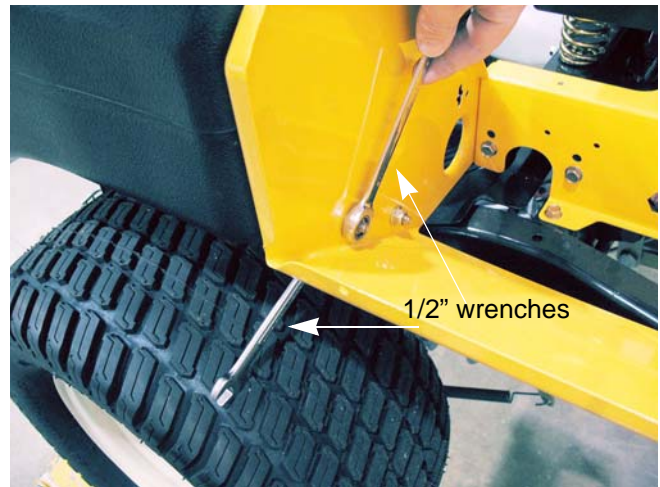

Figure 4.19

7. Remove the two screws that hold the rear of the control console to the seat box assembly using a T-30 torx driver and a 7/16" wrench. See Figure 4.20.

NOTE: On mowers equipped with a 60" deck, the upper screw will go through a reinforcement plate for the lift assist spring.

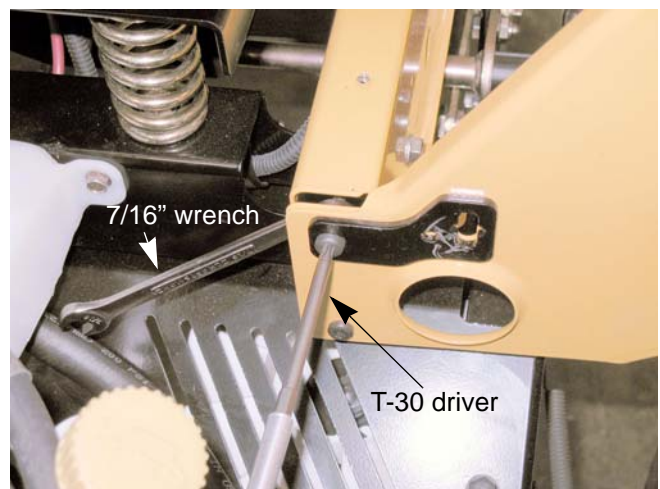

Figure 4.20

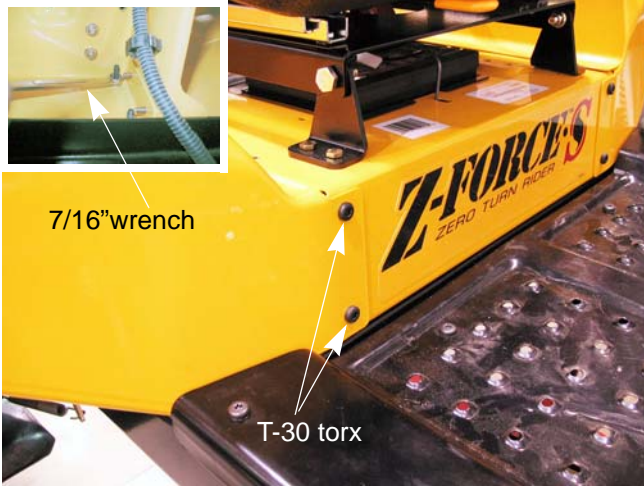

Figure 4.21

8. Remove the screws that hold the front of the control console to the front of the seat box assembly using a T-30 torx driver and a 7/16" wrench. See Figure 4.21.
9. Lift the control console off of the mower.
10. Install the control console by following the previous steps in reverse order.
11. Test drive the mower in a safe area before returning it to service.

Z-Force-S

Seat

To remove/replace the seat:

1. Disconnect the seat switch.
2. Remove the four nuts that hold the seat track to the seat base using a 1/2" wrench. See Figure 4.22.
3. Lift the seat off of the base.

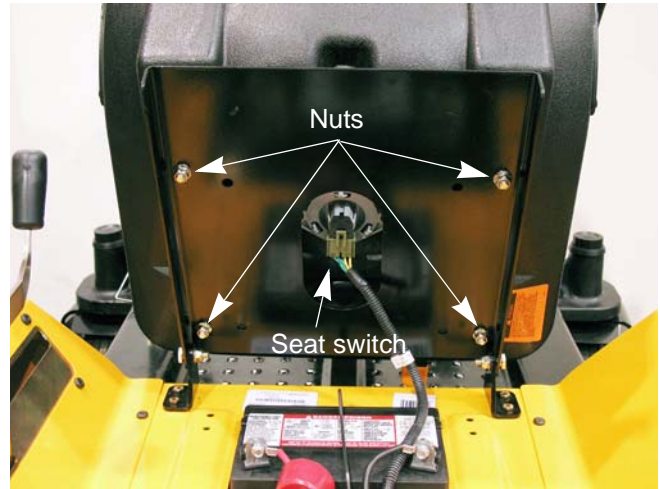

Figure 4.22

NOTE: The track is serviced as part of the seat and is not available separately.

4. Remove the seat switch using a 3/8" wrench. See Figure 4.23.
5. Install the seat by following the previous steps in reverse order.
6. Test drive the mower in a safe area before returning it to service.

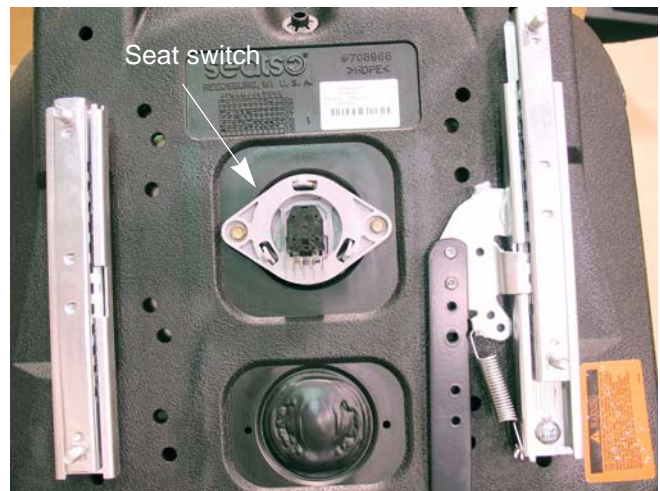

Figure 4.23

Seat box assembly

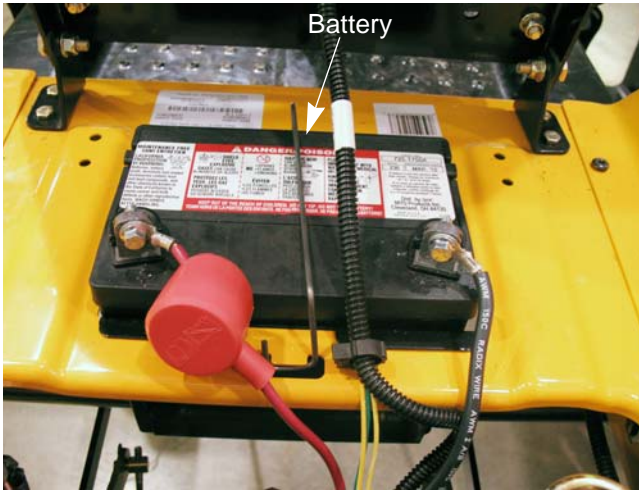

Figure 4.24

To remove/replace the seat box assembly:

1. Remove the battery and battery box. See Figure 4.24.
2. Disconnect the seat switch.

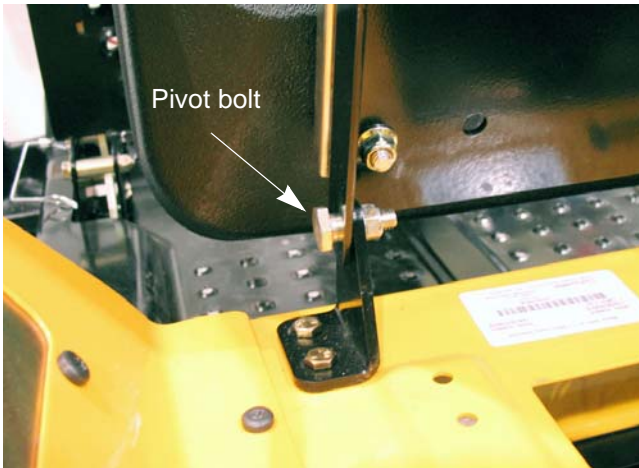

Figure 4.25

3. Remove the seat pivot bolts. See Figure 4.25.
4. Remove the seat from the mower.

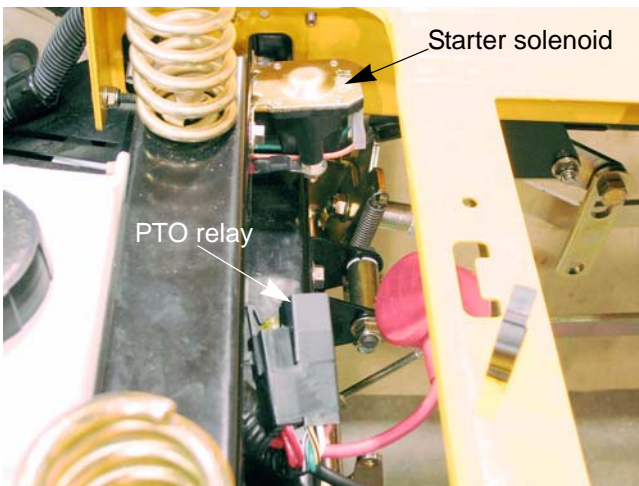

Figure 4.26

5. Disconnect the fuse holder/PTO relay from the seat box. See Figure 4.26.
6. Remove the two screws and nuts that hold the starter solenoid to the seat box.

NOTE: The wires do not need to be disconnected. The solenoid can be left hanging.

7. Remove the left control console by following the procedures described in the left control console section of this chapter.
8. Remove the right control console by following the procedures described in the right control console section of this chapter.

Z-Force-S

9. Disconnect the reverse switch harness from the conduit clip on the right side of the seat box. See Figure 4.27.

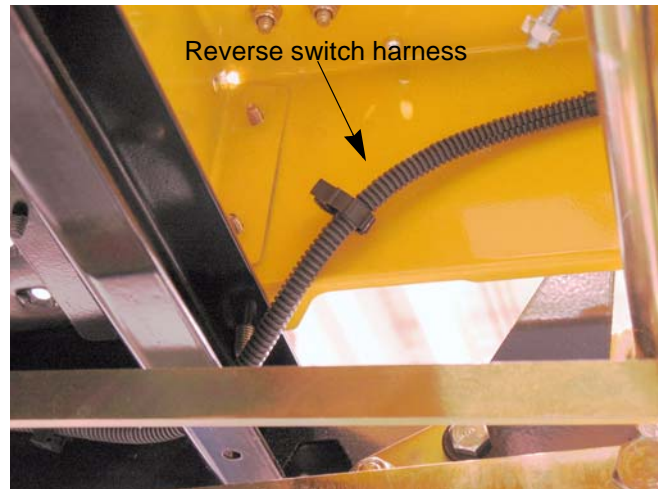

Figure 4.27

10. Remove the four screws (two on each side) that hold the seat box assembly to the frame using a 1/2" wrench. See Figure 4.28.
11. Lift the seat box assembly off of the mower.
12. Install the seat box by following the previous steps in reverse order.
13. Test drive the mower in a safe area before returning it to service.

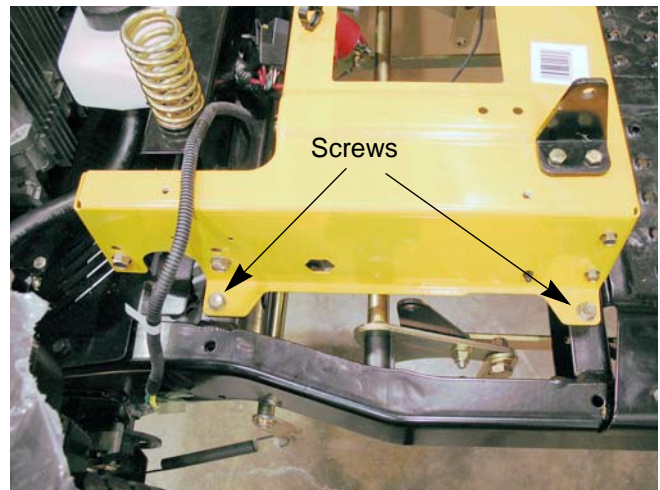

Figure 4.28

CHAPTER 5: DRIVE

The Z-Force S is built using two different models of HydroGear transmissions. The 48" deck version is equipped with two HydroGear EZT transmissions. The 60" version is equipped with two ZT2800 transmissions.

The Hydro-gear shop manual for the EZT transmissions is form number BLN-52622. The Hydro-gear shop manual for the ZT2800 transmissions is form number BLN-52441. These manuals are available through HydroGear.

Drive belt

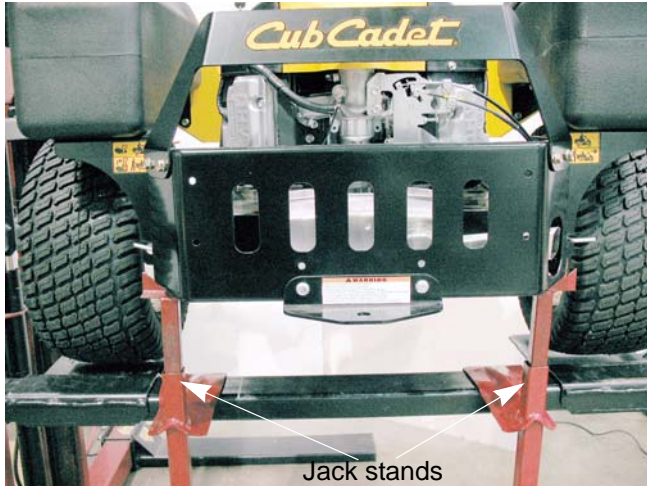

Figure 5.1

The drive belt is the most common drive system component that will need attention. To remove/replace the drive belt:

NOTE: The procedure to replace the drive belt is the same for both transmission models.

1. Remove the deck as described in chapter 8: Cutting Decks and Lift Shaft.
2. Set the parking brake.
3. Lift and safely support the rear of the mower.
4. Remove one of the rear wheels. See Figure 5.1.

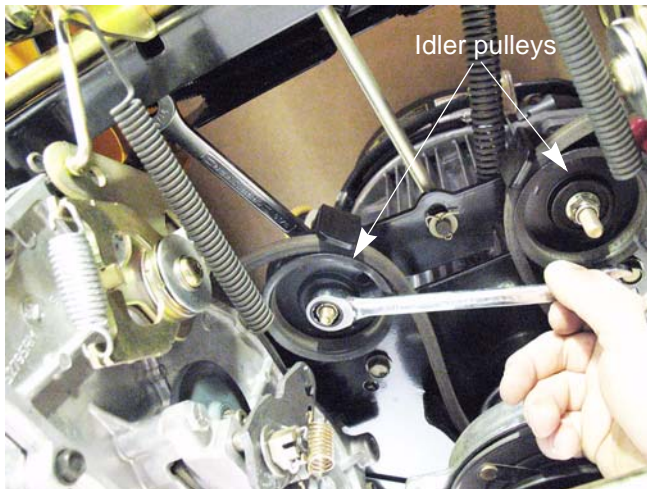

Figure 5.2

5. Loosen the idler pulleys using a pair of 9/16" wrenches. See Figure 5.2.
6. Slip the belt past the belt guides and off of the idler pulleys.

Z-Force-S

7. Remove the two screws that secure the fan cover to the frame using a 1/2" wrench. See Figure 5.3.

NOTE: On the mowers equipped with a 60" deck, the screw on the left side also goes through the harness clamp. See Figure 5.3. Insert.

8. Slide the fan cover out of the mower on the side that has the tire removed.

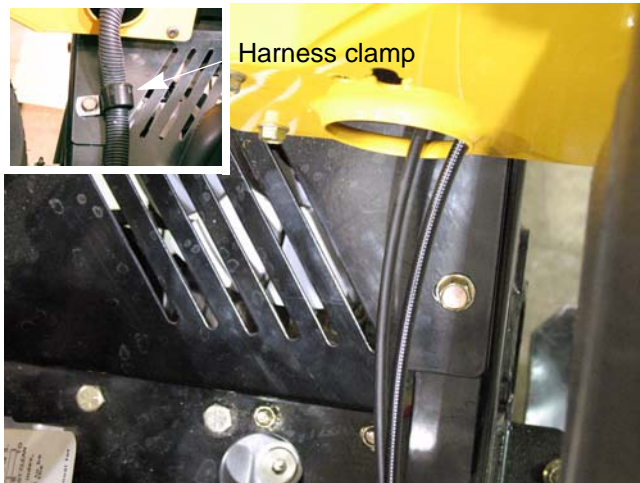

Figure 5.3

9. Remove the transmission fans using a 3/8" wrench.
10. Slide the drive belt off of the transmission pulleys.



Figure 5.4

11. Unplug the electric PTO harness. See Figure 5.1.
12. Unbolt the electric PTO using an impact wrench and a 5/8" socket. See Figure 5.5.

NOTE: If the PTO clutch will not slide off of the crankshaft, thread the bolt half way into the crankshaft. Make sure the belt keeper is in place to prevent the clutch from rotating. Start the engine and turn the PTO on and off several times to shake it loose.

NOTE: If the PTO will not come off using the steps above, remove the engine mounting bolts and slide the engine forward. This will give enough clearance to slide the belt off of the engine pulley.

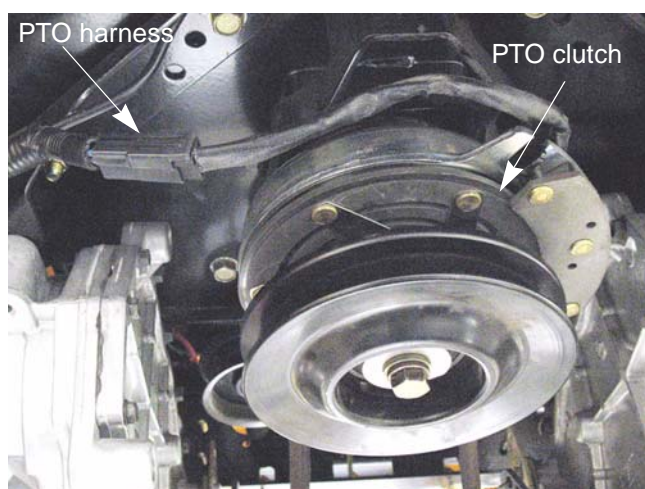

Figure 5.5

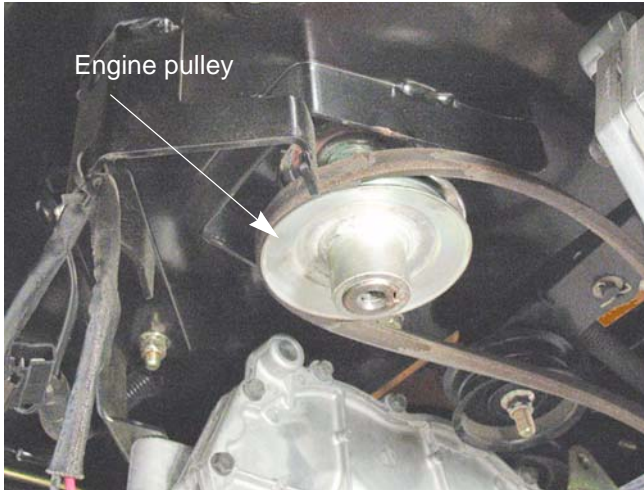

Figure 5.6

13. Slide the engine pulley down far enough to slip the belt off of the pulley. See Figure 5.6.

NOTE: Note the direction of the key in the engine pulley. It should be facing down. If the pulley is installed upside down, the belt alignment will be off.

NOTE: When installing the engine pulley and electric PTO, coat the crank shaft with anti-seize. This will ease pulley and clutch removal in the future.

NOTE: If the engine pulley is seized to the crankshaft, the engine bolts can be removed to slide the engine to the rear. This will provide enough clearance to remove the belt.



Cub Cadet belts are designed to fit our equipment and are not standard lengths. Use of a non-OEM belt may prevent the de-clutching mechanism from working properly when the brakes are applied.

14. The belt can now be snaked out of the mower.
15. Install the belt following the above steps in reverse order.
NOTE: Tighten the electric PTO clutch bolt to a torque of 450 - 600 in-lbs (51 - 68 Nm).
16. Test drive the mower before returning to service.

Z-Force-S

Drive belt adjustment

The drive belt is tensioned by a spring loaded idler pulley. When the brakes are applied, the drive belt is de-clutched. An adjustable linkage connects the tensioning pulley to the brake shaft. A brake link that is out of adjustment will prevent the moveable idler from correctly tensioning and de-tensioning the belt.

As the belt wears and stretches, the moveable idler needs to push the belt in further to keep proper belt tension. To do this, the ferrule at the end of the brake link needs to be at the middle of the slot in the idler pulley bracket. To adjust this brake link:

NOTE: The brake link is properly adjusted when the belt is fully de-clutched as the brake is applied and fully tensioned when the brake is released.

NOTE: The belt must be on when performing this adjustment.

1. Release the parking brake.
2. Remove the deck as described in chapter 8 Cutting Decks and Lift Shaft.
3. Remove the cotter pin and washer from the ferrule on the end of the brake link. See Figure 5.7.
4. Slide the ferrule out of the idler bracket.
5. Adjust the ferrule so that it lines up with the middle of the slot and slides in without pulling on the spring. See Figure 5.8.
6. Install the washer and a new cotter pin.
7. Test drive the mower before returning to service.
8. Re-attach the deck.

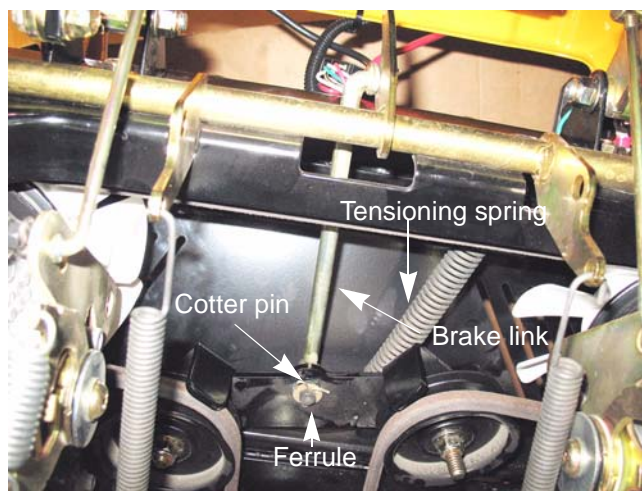

Figure 5.7

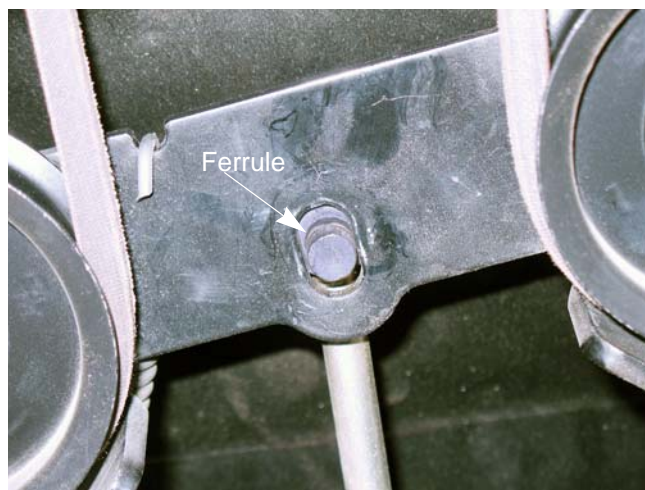

Figure 5.8

EZT transmission removal/replacement

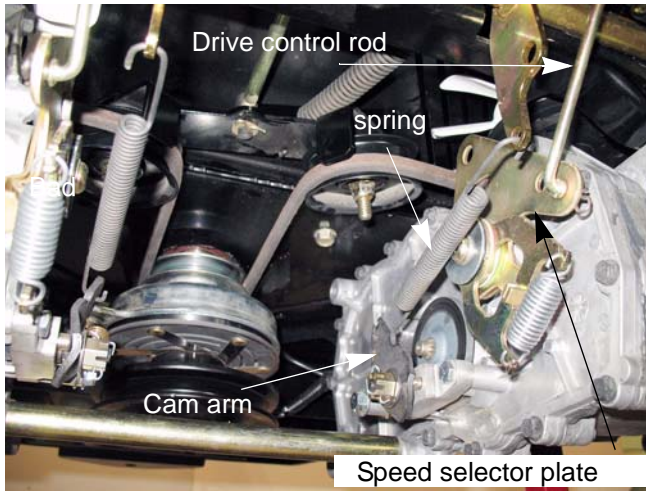

Figure 5.9

1. Remove the deck as described in Chapter 8 Cutting Decks and Lift Shaft.
 2. Lift and safely support the rear of the mower.
 3. Remove the drive belt by following the procedures described previously in this chapter.
- NOTE:** When removing the belt, remove the wheel of the transmission to be removed.
4. Disconnect the brake rod spring from the cam arm. See Figure 5.9.
 5. Remove the bowtie clips that secure the drive control rods to the speed selector plates.
 6. Slide the rods out of the selector plate.

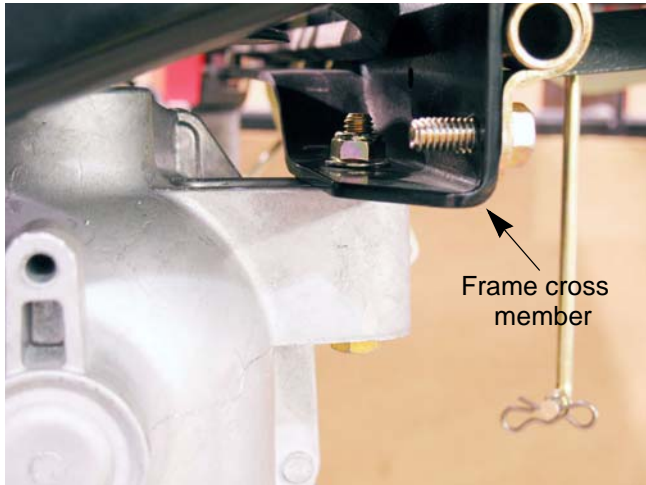

Figure 5.10

7. Remove the nut and bolt that hold the front of the transmission to the frame cross member using a pair of 1/2" wrenches. See Figure 5.10.

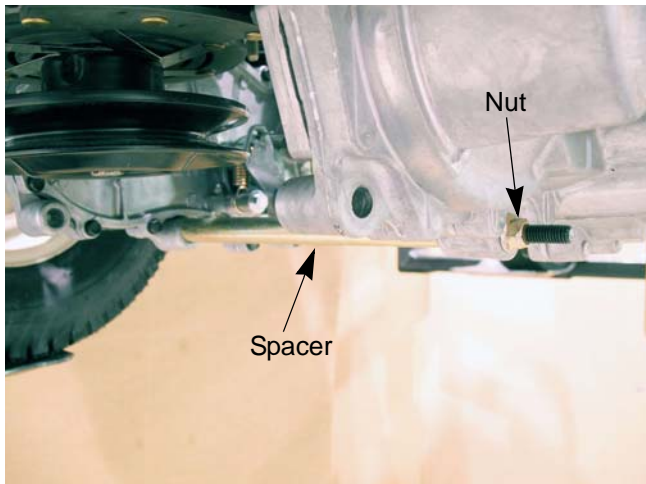

Figure 5.11

8. Remove the nut, T-bolt and spacer that connect the transmissions to each other. See Figure 5.11.

Z-Force-S

9. Remove the bolt holding the rear of the transmission to the torque bracket. See Figure 5.12.

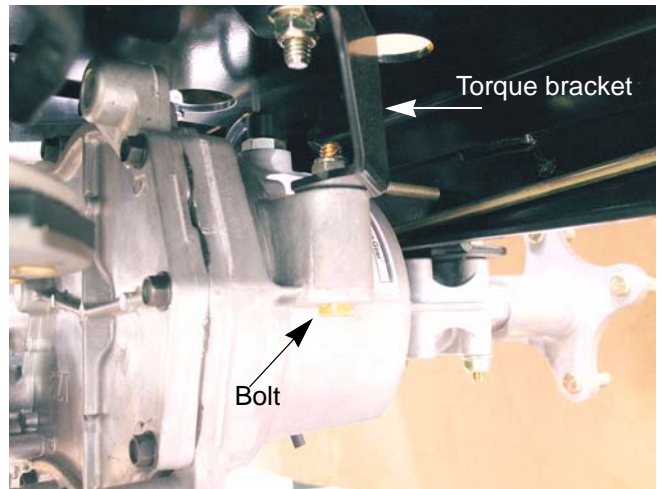

Figure 5.12

10. Support the transmission to prevent it from falling while the mounting bolts are removed.
11. Remove the two bolts that fasten the transmission to the frame. See Figure 5.15.
12. Lower the transmission enough to gain access to the by-pass rod.
13. Remove the hair pin clip that secure the by-pass rod to the by-pass lever. See Figure 5.14.
14. Lift the by-pass rod off of the by pass lever.
15. Remove the transmission from the mower.
16. Install the transmission by following the previous steps in reverse order.

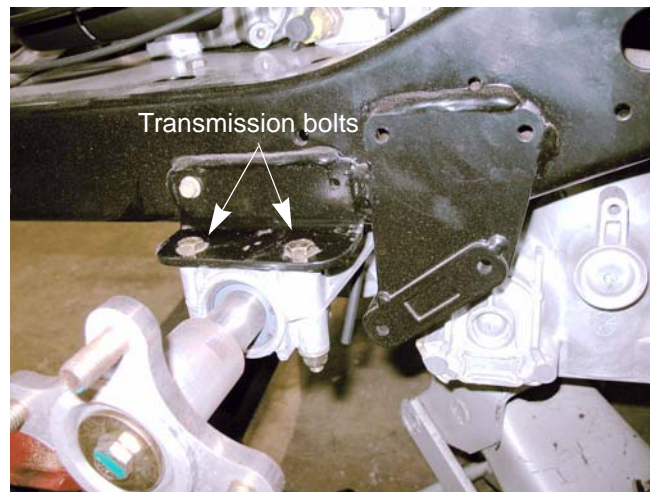

Figure 5.13

NOTE: Before lowering the mower to the ground purge the transmission by:

- Move the by-pass rod to the by-pass position.
 - Start the engine.
 - Cycle the drive pedal from full forward to full reverse six times.
 - Move the by-pass rod to the drive position.
 - Cycle the drive pedal from full forward to full reverse six times.
17. Perform a neutral adjustment and wheel alignment by following the steps described in 6: Steering.
 18. Test drive the mower before returning it to service.

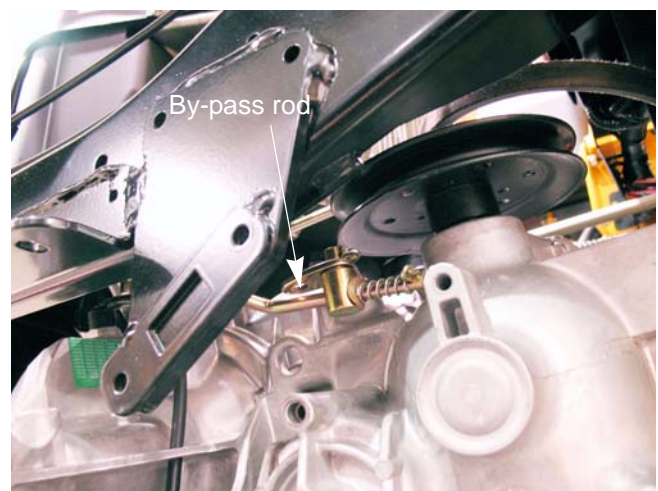

Figure 5.14

ZT 2800 transmission removal/replacement



Figure 5.15

1. Remove the deck as described in chapter 8 Cutting Decks and Lift Shaft.
2. Lift and safely support the rear of the mower.
3. Remove the drive belt by following the procedures described previously in this chapter.

NOTE: When removing the belt, remove the wheel of the transmission to be removed.

4. Release the parking brake.

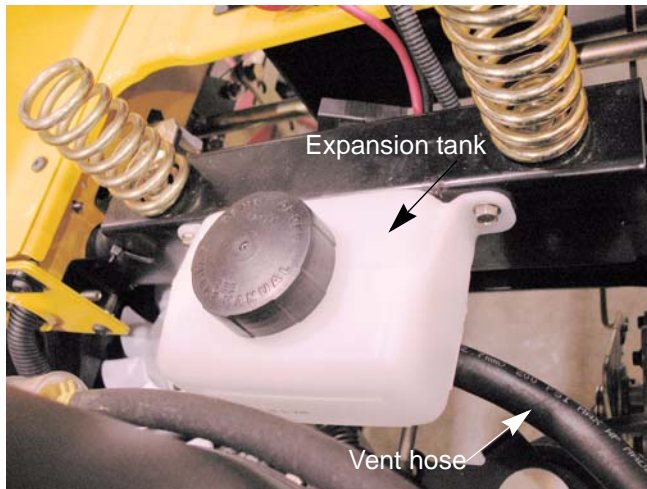

Figure 5.16

5. Remove the two screws that hold the expansion tank to the seat box using a 7/16" wrench. See Figure 5.16.

6. Follow the vent hose from the transmission to be removed up to the expansion tank.
7. Using a pair of pliers, squeeze the tabs on the hose clamp together while sliding the clamp down the hose.
8. Carefully remove the vent hose from the expansion tank.

NOTE: The expansion tank should be empty when the transmission is cold.

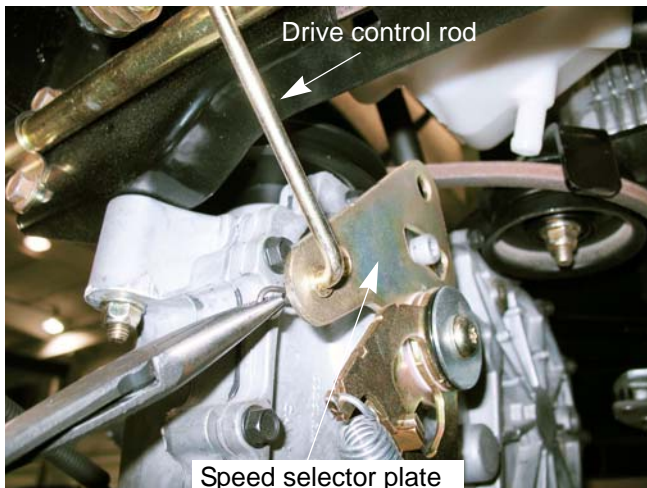

Figure 5.17

9. Remove the bowtie clip that secures the drive control rod to the speed selector plate.
10. Slide the rod out of the selector plate.

Z-Force-S

11. Remove the nut and bolt that hold the front of the transmission to the frame cross member using a pair of 1/2" wrenches. See Figure 5.18.

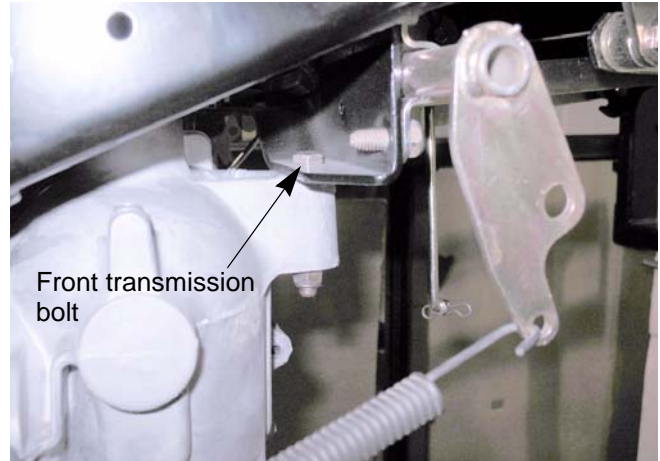

Figure 5.18

12. Remove the nut, T-bolt and spacer that connect the transmissions to each other. See Figure 5.19.

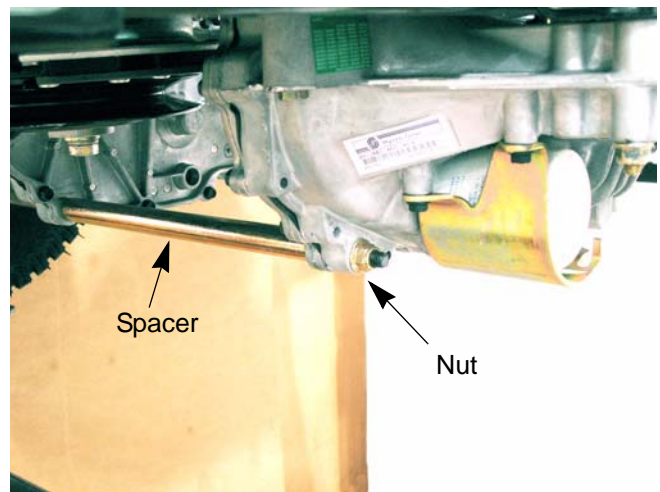

Figure 5.19

13. Remove the bolt holding the rear of the transmission to the torque bracket. See Figure 5.20.

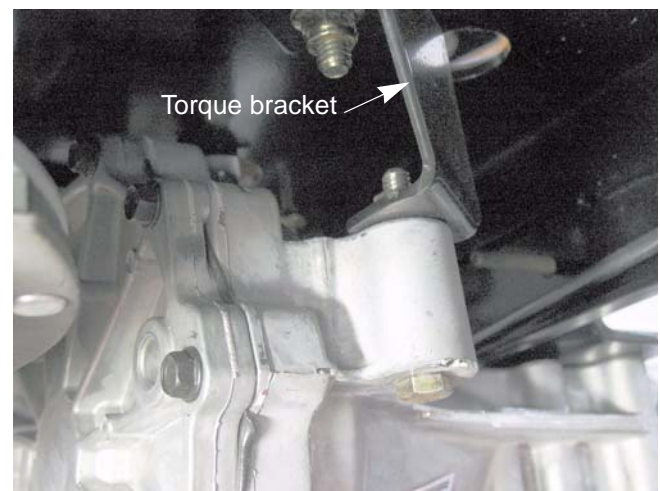

Figure 5.20

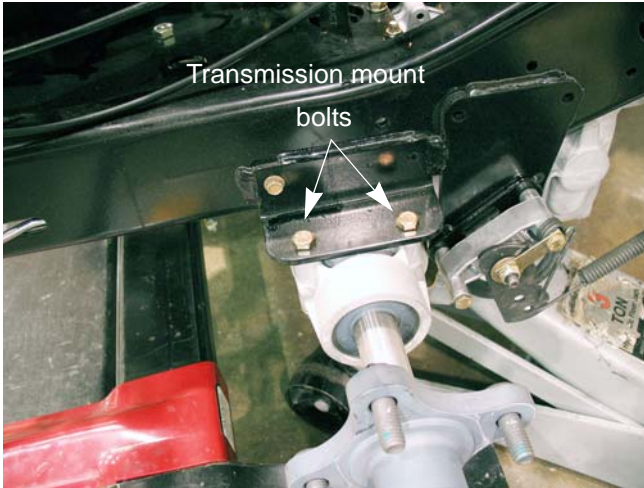

Figure 5.21

14. Support the transmission to prevent it from falling while the mounting bolts are removed.
15. Remove the two bolts that fasten the transmission to the frame. See Figure 5.21.

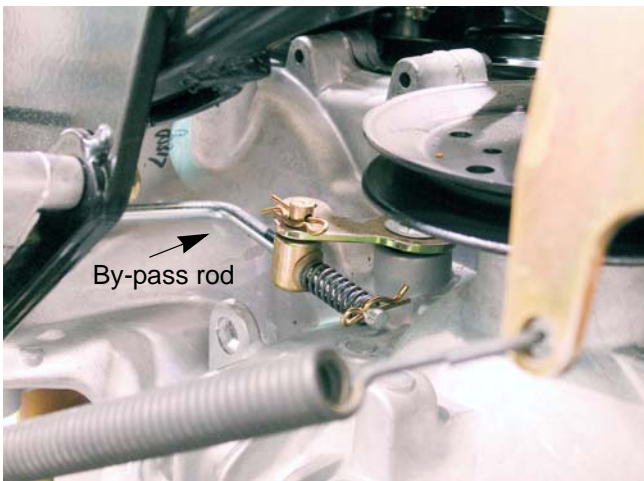

Figure 5.22

16. Lower the transmission enough to gain access to the by-pass rod.
17. Remove the hair pin clip that secure the by-pass rod to the by-pass lever. See Figure 5.14.
18. Lift the by-pass rod off of the by pass lever.
19. Remove the transmission from the mower.

NOTE: If replacing the transmission, inspect the vent hose. If it is in good condition remove it from the old transmission and install it on the new transmission. If it cracked, brittle or damaged, install a new vent hose on the new transmission.

20. Install the transmission by following the previous steps in reverse order.

NOTE: Before lowering the mower to the ground purge the transmission by:

- Move the by-pass rod to the by-pass position.
- Start the engine.
- Cycle the drive pedal from full toward to full reverse six times.
- Move the by-pass rod to the drive position.
- Cycle the drive pedal from full forward to full reverse six times.

NOTE: Removal of the brake caliper will make installing the transmission easier, but is not required.

21. Perform a neutral adjustment and wheel alignment by following the steps described in 6: Steering.
22. Test drive the mower before returning it to service.

Z-Force-S

Drive pedal biasing adjustment

The Z-Force-S is equipped with a pedal biasing cam. This cam allows the pedals to be adjusted to increase forward travel speed or reverse travel speed. To adjust the pedal biasing:

1. Remove the floor pan by following the procedures described in Chapter 4 Body.
2. Inspect the bushings that support the forward drive pedal shaft. See Figure 5.23.

NOTE: Any wear in the bushings will affect pedal travel. Replace worn bushings before adjusting pedal biasing cam.

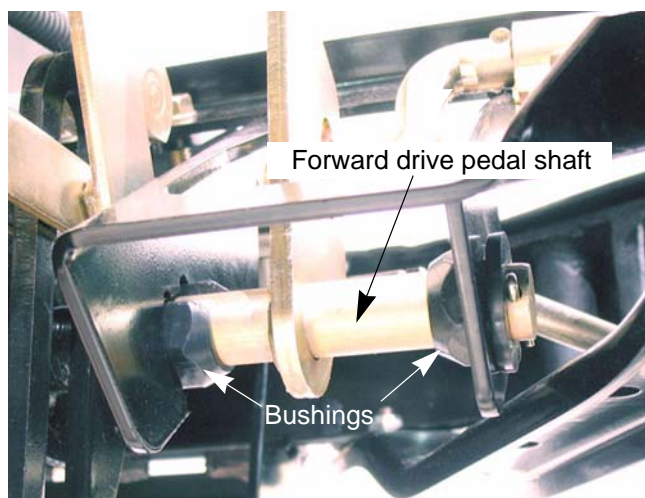

Figure 5.23

3. Loosen the biasing cam lock bolt using a 9/16" wrench while holding the biasing cam with a 3/4" wrench.
4. Rotate the cam using a 3/4" wrench while watching the forward drive pedal arm. See Figure 5.24.

NOTE: Adjusting the forward drive arm towards the front of the mower will give more reverse pedal travel and less forward pedal travel. Adjusting the forward drive pedal arm towards the rear of the mower will increase forward pedal travel and decrease reverse pedal travel.

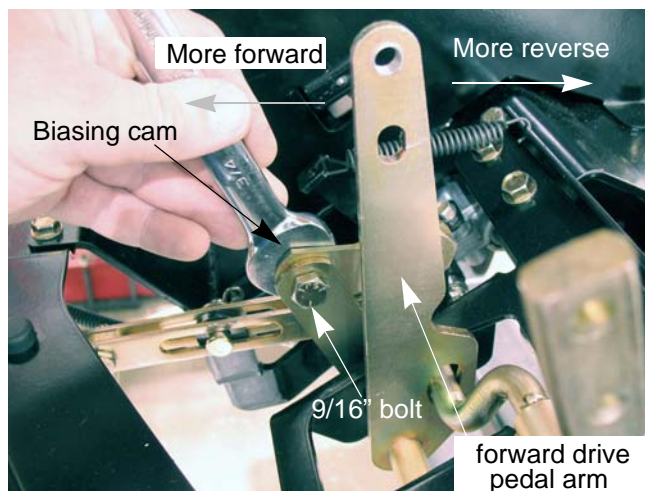

Figure 5.24

NOTE: When the bolt hole in the biasing cam is at the top center or bottom center position, The cam is in the neutral bias position. See Figure 5.25.

5. Tighten the biasing cam lock bolt using a 9/16" wrench while holding the biasing cam in place with a 3/4" wrench.
6. Install the floor pan by following the procedures described in Chapter 4: Body.
7. Test drive the mower in a safe area before returning it to service.

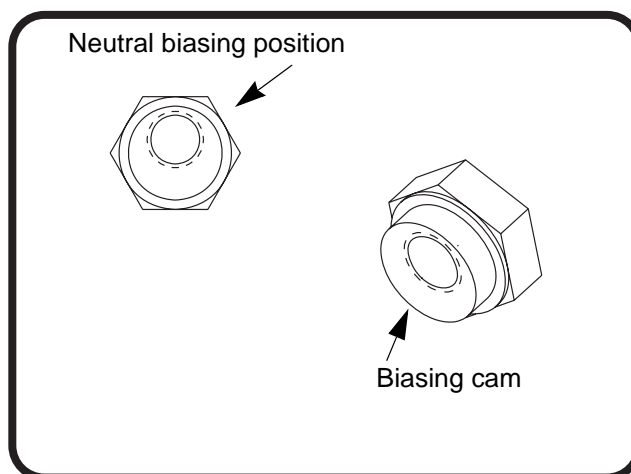

Figure 5.25

Hydro neutral control adjustment

NOTE: Neutral control rarely goes out of adjustment on its own. If it needs adjustment, check for damaged linkage or signs of tampering.



The mower engine and drive system must be operated to complete this procedure. Confirm that no hazards will be incurred by running the engine or operating the drive system.

- Work in a well vented area to prevent carbon monoxide poisoning or asphyxiation.
- Be careful to avoid contact with hot parts or moving parts.

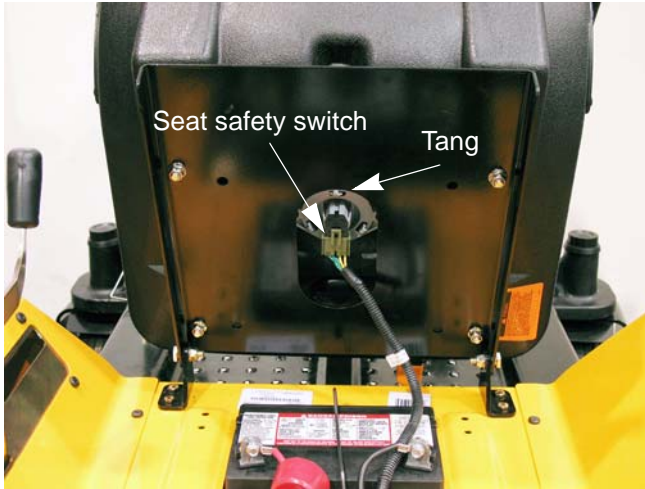

Figure 5.26

To perform the hydro neutral control adjustment:

NOTE: The procedure to perform the hydro neutral control adjustment is the same for the ZT 2800 and the EZT transmissions.

1. Lift and safely support the rear of the mower.
2. By-pass the seat safety switch. See Figure 5.26.
 - 2a. Slide the seat to the full forward position.
 - 2b. Flip the seat up.
 - 2c. Press in the seat bottom until the tang on the seat switch is fully extended.
 - 2d. Place a spring clamp on the tang to hold the seat switch in this position.
3. Remove the four screws that hold the steering column cover in place using a T-30 torx driver.
4. Lock Steering Gear Box in Neutral Position:
 - 4a. Remove the 1/4"-20 plug screw from the steering gear box centering port using a 3/8" wrench. See Figure 6.27.
 - 4b. Thread a 1/4"-20x2" bolt into the steering box centering port until you feel it touch the steering rack.
 - 4c. While trying to gently thread the bolt further, slowly rotate the steering shaft back and forth until the bolt seats into the detent in the steering rack.
 - 4d. Finger tighten the screw to set the screw fully into the detent. The steering gear box is now centered and locked.

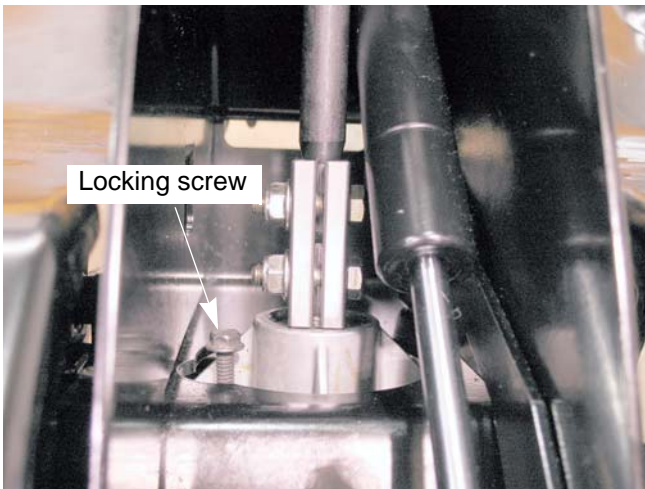

Figure 6.27

Z-Force-S

5. Disconnect both of the drive control arms from the speed selector plates. See Figure 5.28.

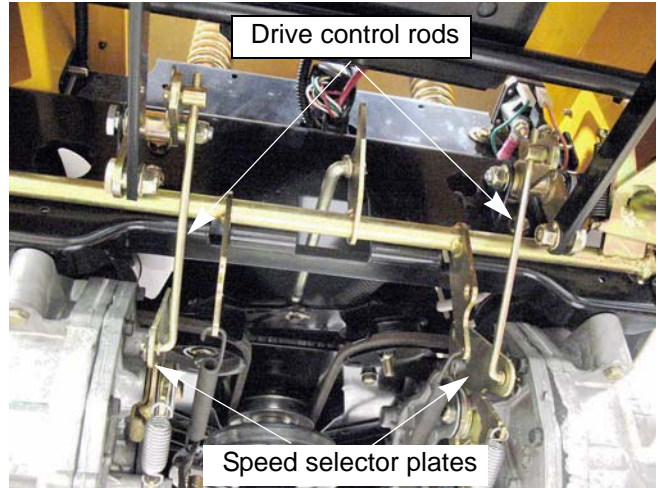

Figure 5.28

6. Start the engine and advance throttle to maximum RPM.
7. Release the parking brake.
8. Watch both rear tires for movement. See Figure 5.29.

NOTE: If there is no wheel movement, the hydro transmissions are in neutral and don't need to be adjusted. Skip ahead to step 13.

NOTE: If one or both rear wheels move, the hydro transmissions need to be adjusted. Continue on to step 9.

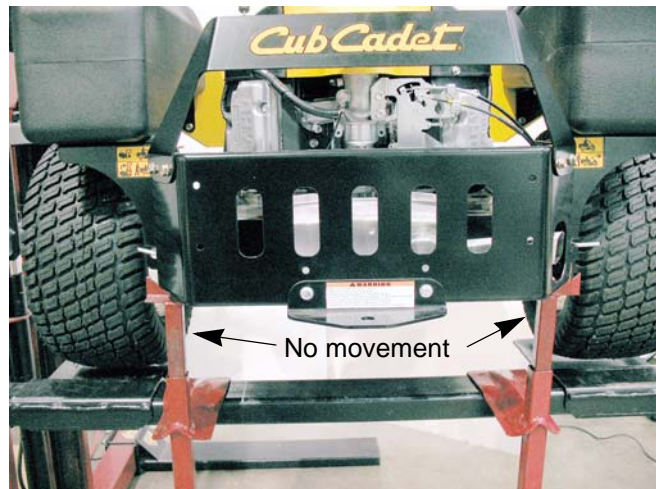

Figure 5.29

9. With the engine still running, locate the socket head cap screw in the slot of the speed selector plate on the transmission that needs to be adjusted.
10. Loosen the socket head cap screw using a 1/4" hex key. See Figure 5.30.
11. Adjust the speed selector plate until the wheel stops moving.
12. Tighten the socket head cap screw using a 1/4" hex key.
13. Turn-off the engine.

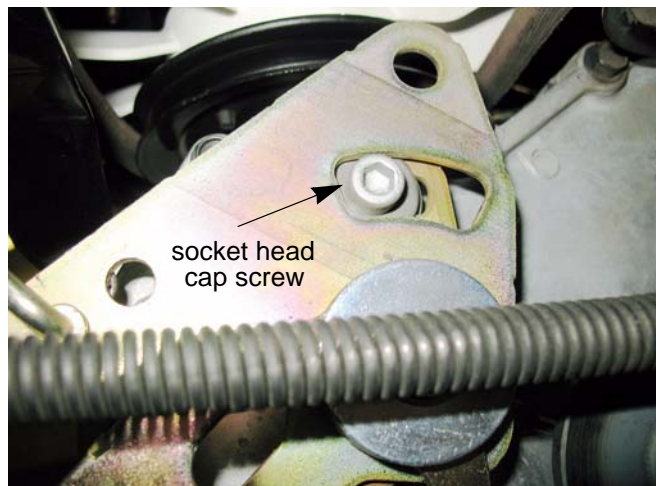

Figure 5.30

14. Adjust the drive control rods so they slide freely into the hole in the selector plate. Install the hairpin clips.
15. Remove the spring clamp from the seat switch.
16. Lower the mower to the ground.
17. Test the drive system and all safety features before returning the unit to service.

CHAPTER 6: STEERING

Introduction

The steering on the Z-Force-S mower works in two phases.

- First it will steer like any other riding mower by turning the front wheels.
- Second and more importantly, the steering linkage will control the drive output of the rear wheels through the use of two HydroGear transmissions.

The steering gear box is connected to the front wheels by tie rods. When the steering wheel is turned, the gear box will turn the front wheels. The gear box will also slow the drive speed of the rear wheels. The inside wheel is slowed more than the outside wheel. When the inside front wheel reaches an angle of 90°, the rear wheel on that side will stop driving. Turning the wheel past that point will make the inside rear wheel go in reverse. The inside front wheel can reach a 108° angle with the transmission on the inside of the turn driving in reverse. The riding mower will then make a zero radius turn.

Because the steering gear box is linked to the transmissions, the transmission adjustments and the wheel alignment must be done together. A transmission that is out of adjustment can make the steering look out of adjustment just as a steering linkage that is out of adjustment will affect the transmissions.

IMPORTANT: Check the tire air pressure and wear before attempting to diagnose any problems with the steering or tracking of a Z-Force-S riding mower. If the tires are not equal across the same axles, it will greatly affect the performance of the riding mower.

IMPORTANT: All zero turn mowers must have matching tires across the same axle (both front wheels and both back wheels).

Wheel alignment and drive control link adjustments

The wheel alignment and transmission link adjustment are performed together on the Z-force S.

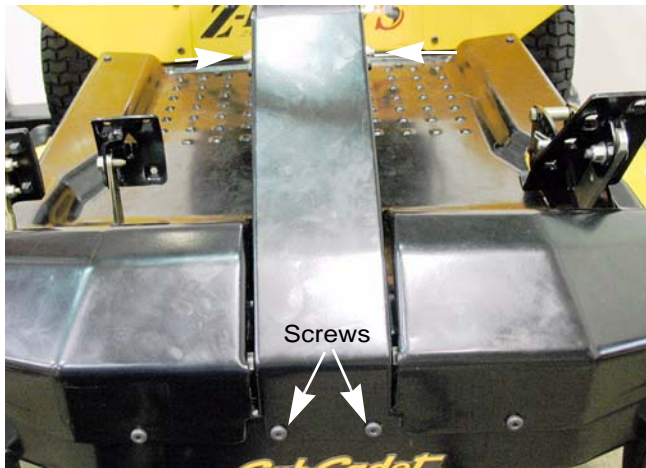

Figure 6.1

- 1 Remove the four screws that hold the steering column cover in place using a T-30 torx driver. See Figure 6.1.

Z-Force-S

2. Lock Steering Gear Box in Neutral Position:
 - 2a. Remove the 1/4"-20 plug screw from the steering gear box centering port using a 3/8" wrench. See Figure 6.2.
 - 2b. Thread a 1/4"-20x2" bolt into the steering box centering port until you feel it touch the steering rack.
 - 2c. While trying to gently thread the bolt further, slowly rotate the steering shaft back and forth until the bolt seats into the detent in the steering rack.
 - 2d. Finger tighten the screw to set the screw fully into the detent. The steering gear box is now centered and locked.

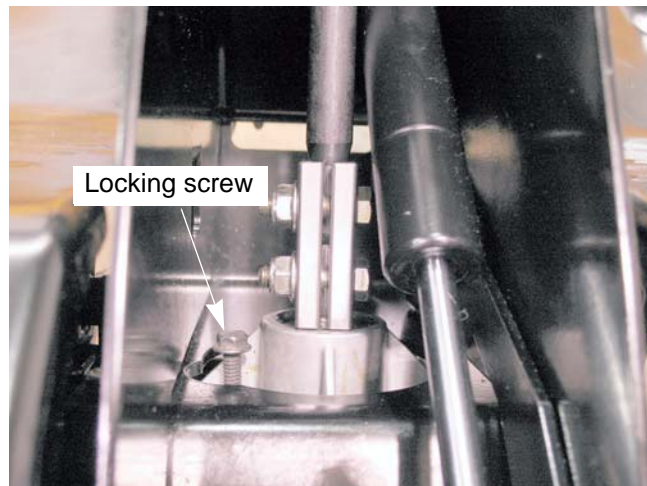

Figure 6.2

3. Remove the hairpin clips that secure the drive control rods to the speed selector plates. See Figure 6.3.
4. Slide the rods out of the selector plate.

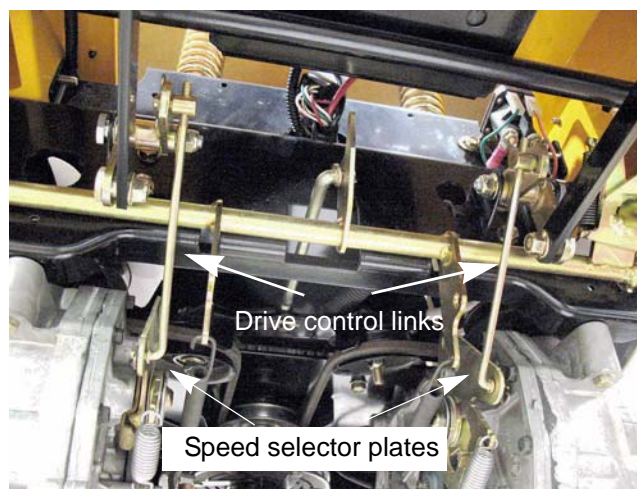

Figure 6.3

5. Insert two 5/16" pins through the holes in the axle castings. The pins should pass through the casting down to the wheel yokes. See Figure 6.4.

NOTE: If both pins slide in, the wheels are aligned; go to step 12. If one or both pins do not slide in, proceed to the next step.

NOTE: The pins should slide in and out without binding. As the drag links are being adjusted, rock the tires back and forth to remove the load created from the tires twisting on the floor.

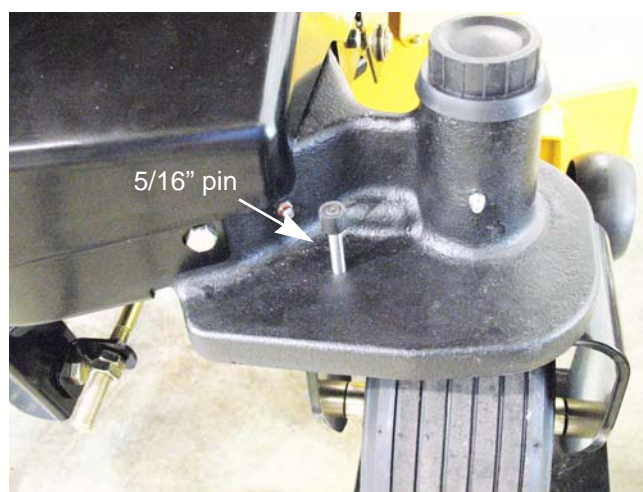

Figure 6.4

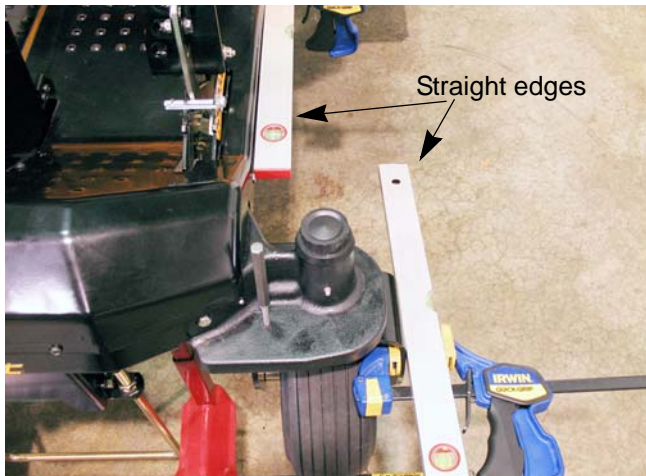

Figure 6.5

NOTE: The flat side of the yoke should be parallel to the box section of the frame when the pins are installed. See Figure 6.5.

NOTE: A couple of straight edges can be used to check the alignment of the yoke to the frame. See Figure 6.5.

If they are not:

- Check for a bent yoke.
- Remove the yoke and check the gear timing. See the yoke section of this chapter for the proper procedures.



Figure 6.6

6. Loosen the jam nuts on both ends of the tie rod(s). See Figure 6.6.

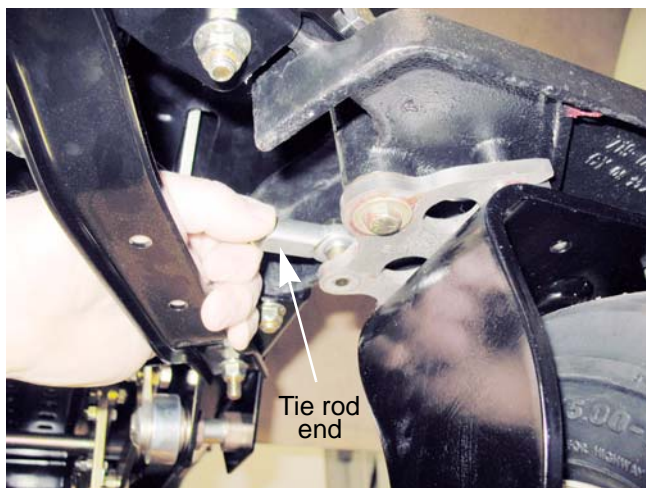

Figure 6.7

7. Disconnect one end of the tie rod. See Figure 6.7.
8. Manually move the front wheel yoke until the alignment holes line up.
9. Insert the 5/16" pin.

Z-Force-S

10. Adjust the tie rods until the ends line up with their mounting point. See Figure 6.8.
11. Re-attach the tie rod(s).
12. Tighten the jam nuts.
13. Adjust the drive control rods so they slide freely into the hole in the selector plate. Install the hairpin clips.
14. Remove the 1/4"-20x2" screw from the steering gear box.
15. Reinstall the original plug screw in the steering gear box.
16. Install the steering column cover.
17. Remove the 5/16" pins.
18. Test drive the riding mower in a safe area before returning it to service.

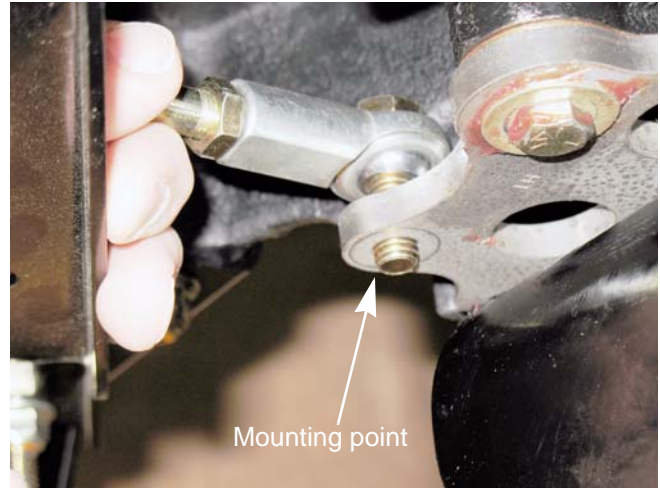

Figure 6.8

Steering gear box removal

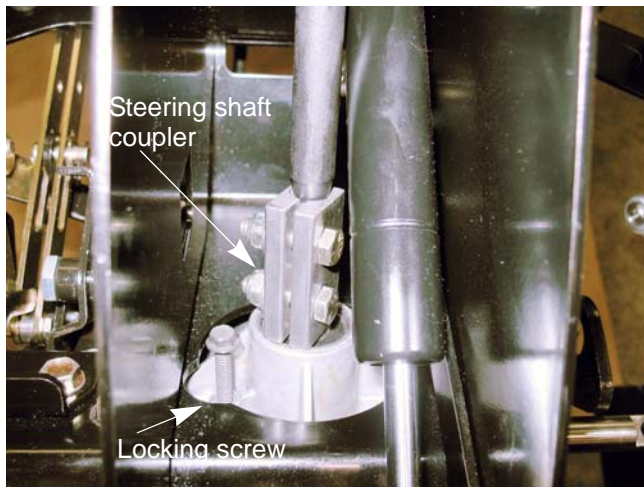

Figure 6.9

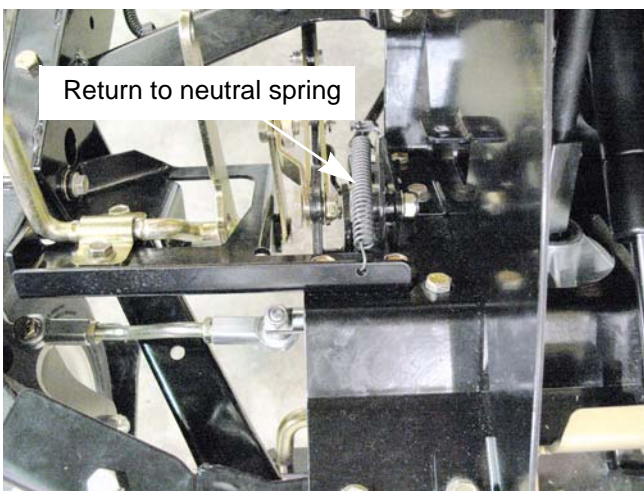

Figure 6.10

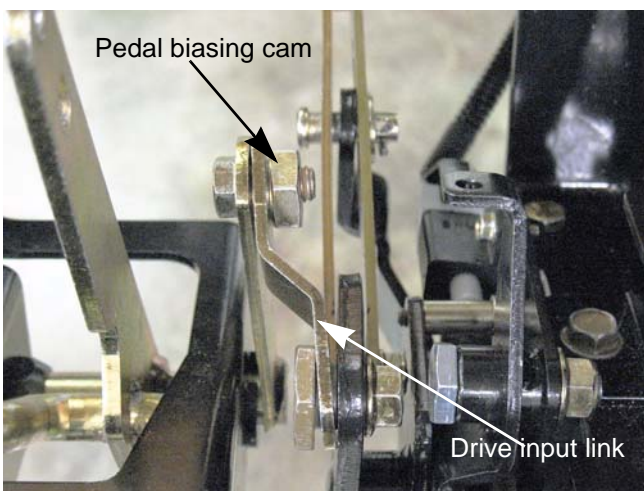

Figure 6.11

To remove/replace the gear box:

- 1 Remove the deck by following the procedures described in Chapter 8: Decks and Lift Shaft.
- 2 Remove the floor pan by following the steps described in Chapter 4: Body/Chassis.
- 3 Remove the four screws that hold the steering column cover in place using a T-30 torx driver.
- 4 Loosen the top clamp bolt in the steering shaft coupler using a pair of 1/2" wrenches.
- 5 Remove the bottom bolt in the steering shaft coupler. See Figure 6.9.

NOTE: The clamp bolts pass through grooves in the steering shaft and the steering gearbox input shaft.

NOTE: It is not necessary to lock the steering gearbox for removal, but it will need to be centered and locked for installation.

- 6 Disconnect the return to neutral spring. See Figure 6.10.

NOTE:

- 7 Disconnect the front side of the drive input link using a 9/16" wrench and a 15/16" wrench. See Figure 6.11.

NOTE: The rear end of the drive input link is attached to the drive pedal shaft by a pedal biasing cam. Removing it will change the pedal travel.

Z-Force-S

8. Disconnect both of the tie rods from the steering gearbox using a pair of 1/2" wrenches. See Figure 6.12.

NOTE: There is a spacer between the tie rod end and the steering rack.

NOTE: The bolt has a special tapered shoulder. Do not replace it with a standard bolt.

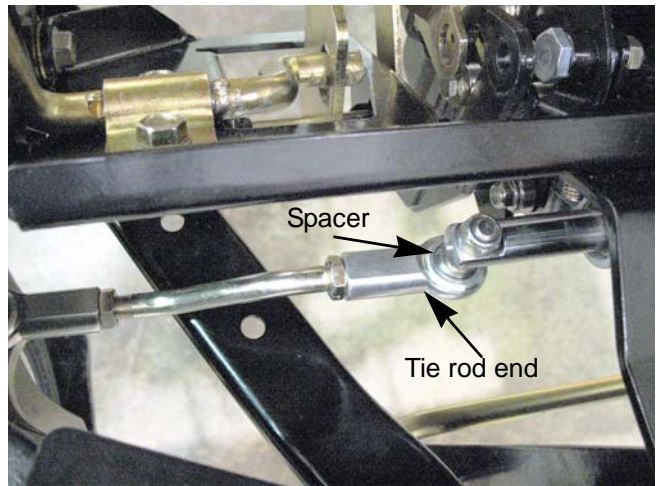

Figure 6.12

9. Disconnect the reverse switch. See Figure 6.13.

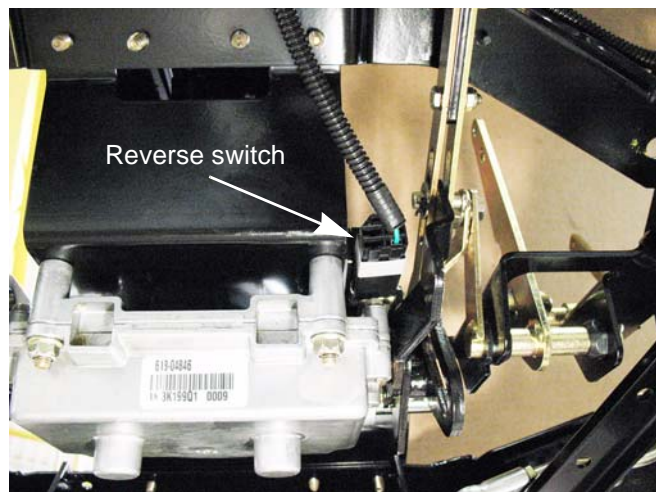

Figure 6.13

10. Disconnect both of the drive control links by removing the nuts and bolts that attach the connector plates to the drive control link using a pair of 7/16" wrenches. See Figure 6.14.

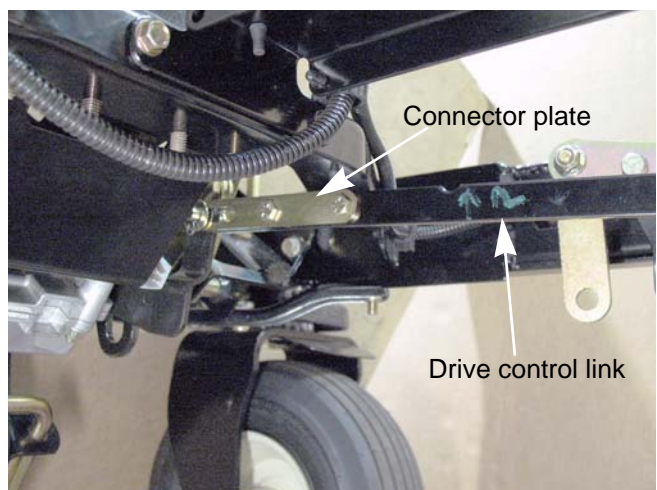

Figure 6.14

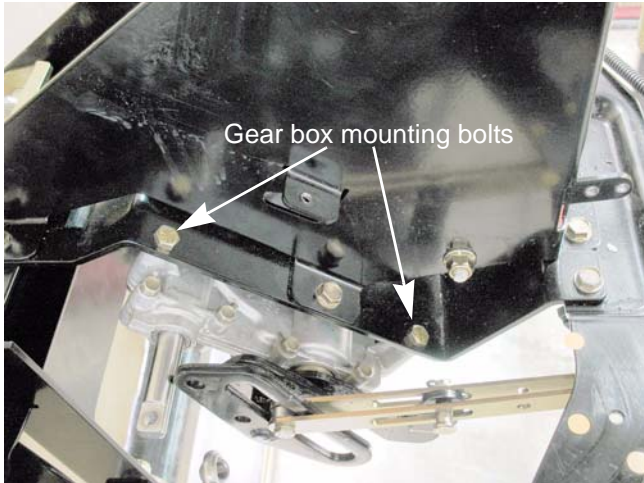

Figure 6.15

11. Remove the four nuts and bolts (two on each side) that hold the gearbox to the frame using a pair of 1/2" wrenches. See Figure 6.15.
12. Lower the steering gearbox out of the mower, sliding it out of the steering shaft coupler.

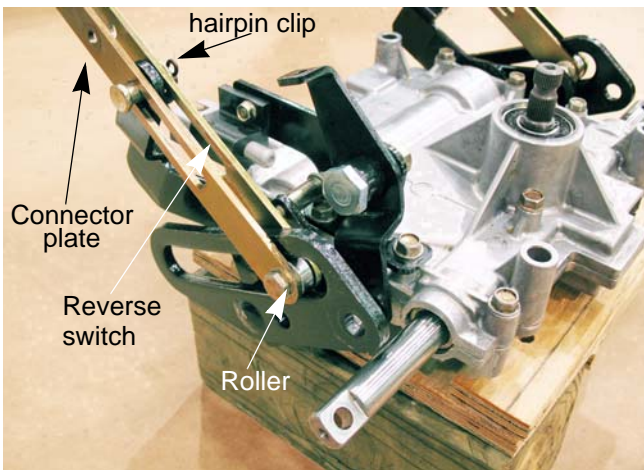

Figure 6.16

NOTE: If replacing the gearbox:

13. Remove the drive control connector plates by:
 - 13a. Remove the cotter pins, washers and clevis pins in the linkages. See Figure 6.16.
 - 13b. Remove the nuts and bolts connecting the transmission linkages to the levers on the steering gear box.

NOTE: There are rollers in the slots. Take care not to lose them when removing the bolts.

14. Remove the reverse switch.

Z-Force-S

Steering gearbox installation

1. Attach the drive control link connector plates to the steering gearbox. See Figure 6.17.
2. Install the reverse switch.

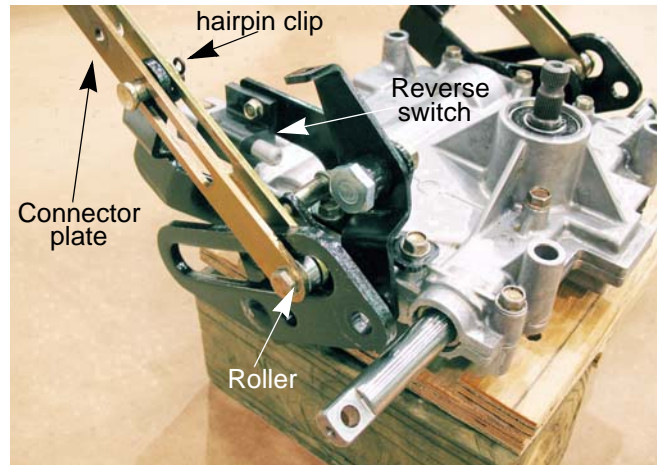

Figure 6.17

3. Lock the steering gearbox in the centered position:
 - 3a. Remove the 1/4"-20 plug screw from the steering gear box centering port using a 3/8" wrench. See Figure 6.18.
 - 3b. Thread a 1/4"-20x2" bolt into the steering box centering port until you feel it touch the steering rack.
 - 3c. While trying to gently thread the bolt further, slowly rotate the input shaft back and forth until the bolt seats into the detent in the steering rack.
 - 3d. Finger tighten the screw to set the screw fully into the detent. The steering gear box is now centered and locked.

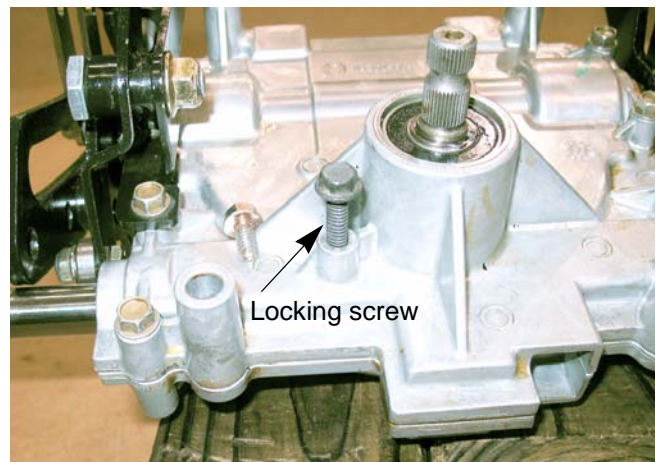

Figure 6.18

4. Remove the hairpin clips that secure the drive control links to the speed selector plates. See Figure 6.19.
5. Slide the rods out of the speed selector plates.

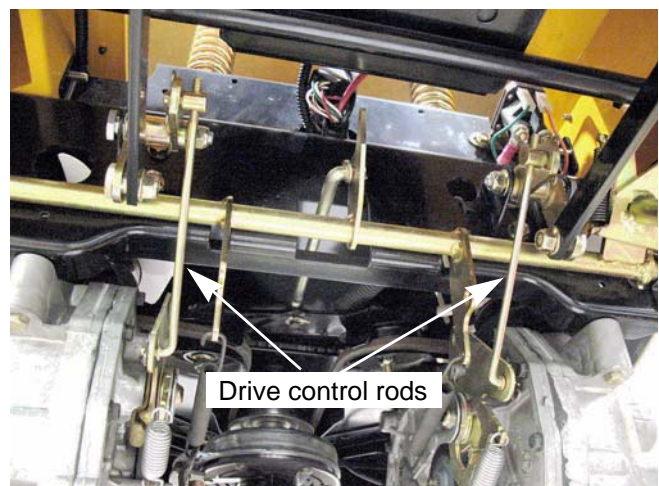

Figure 6.19

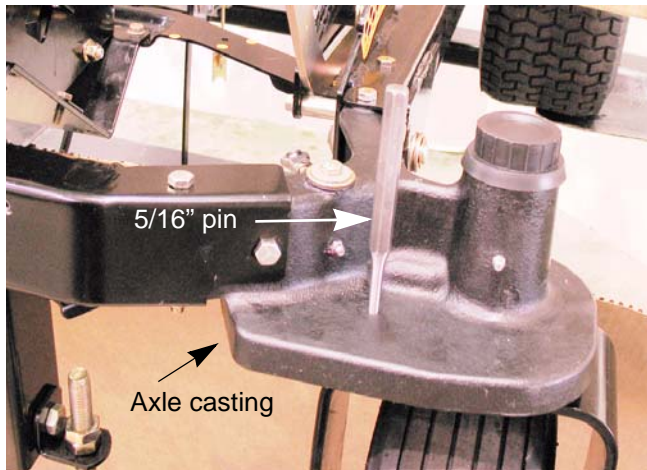

Figure 6.20

6. Insert two 5/16" pins through the holes in the axle castings. The pins should pass through the casting down to the wheel yokes. See Figure 6.20.

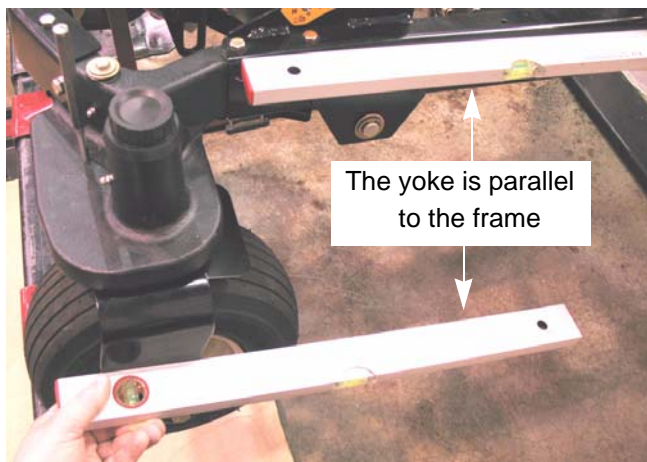

Figure 6.21

NOTE: The flat side of the yoke should be parallel to the box section of the frame when the pins are installed. See Figure 6.21.

If they are not:

- Check for a bent yoke.
- Remove the yoke and check the gear timing. See the yoke section of this chapter for the proper procedures.



Figure 6.22

7. Center the steering wheel. See Figure 6.22.

Z-Force-S

8. Lift the steering gearbox into the frame while sliding the gearbox input shaft into the steering shaft coupler. See Figure 6.23.
9. Install the four mounting nuts and bolts. Tighten to a torque of 17 ft lbs (23 Nm).
10. Install the lower coupler bolt.
11. Tighten both coupler bolts to a torque of 72 in lbs (8 Nm).

NOTE: Once the steering gearbox is mounted, the locking screw can be backed out to allow the steering shaft to be rotated for easier access to the coupler bolt. The steering gearbox must be locked again once the coupler bolts are torqued.

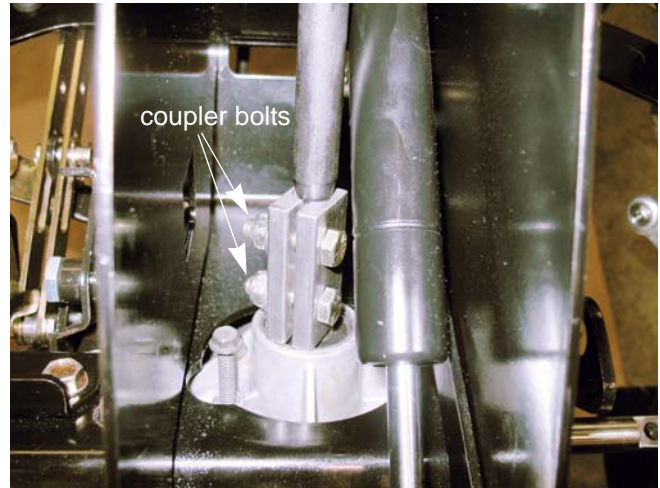

Figure 6.23

12. Attach the tie rods to the steering rack. See Figure 6.24.

NOTE: The spacer must be between the tie rod end and the steering rack.

NOTE: If necessary, adjust the tie rod ends so that the hole in the rod end lines up with the hole in the steering rack.

13. Remove the 5/16" pins.

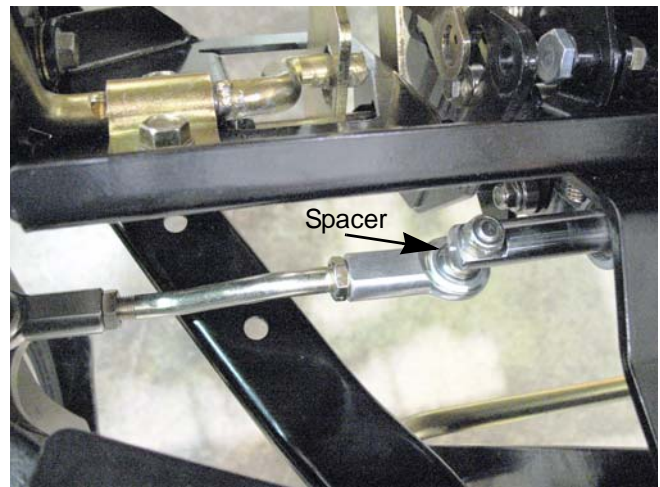

Figure 6.24

14. Attach the front side of the drive input link using a 9/16" wrench and a 15/16" wrench. See Figure 6.25.

NOTE: If the pedal biasing cam was moved, the drive pedal adjustment will need to be performed by following the steps described in the drive pedal adjustment section of Chapter 5: Drive System.

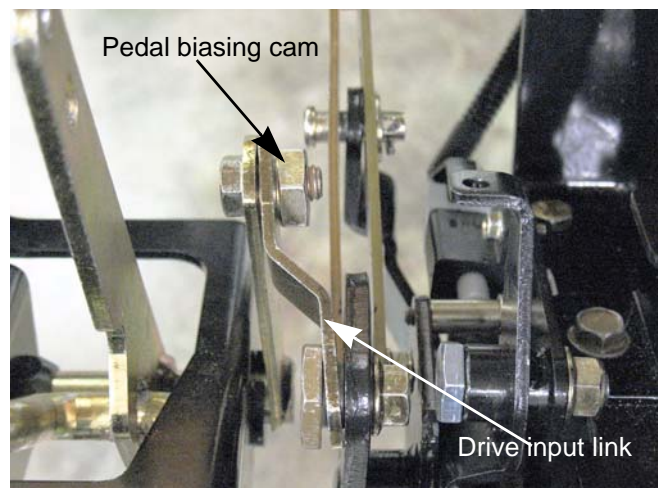

Figure 6.25

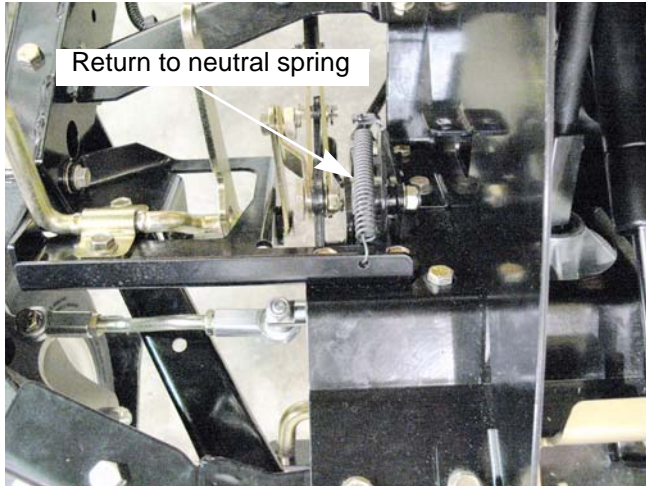

Figure 6.26

15. Install the return to neutral spring. See Figure 6.26.

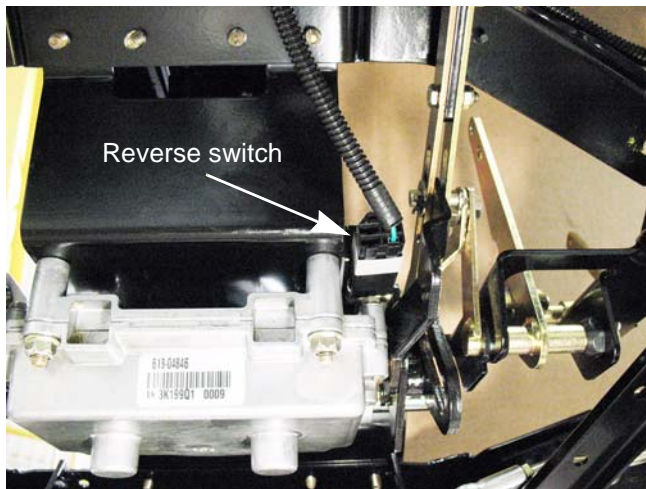

Figure 6.27

16. Connect the reverse switch. See Figure 6.27.

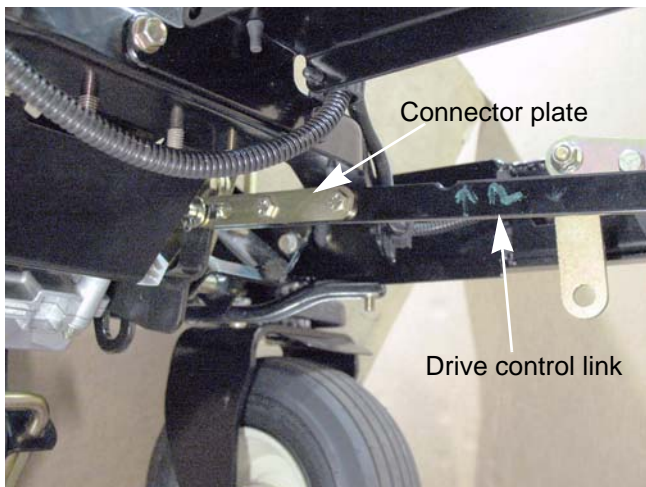

Figure 6.28

17. Connect both of the drive control links by installing the nuts and bolts that attach the connector plates to the drive control link using a pair of 7/16" wrenches. See Figure 6.28.

18. Adjust the drive control links so they slide freely into the hole in the selector plate. Install the hairpin clips.

19. Remove the locking bolt from the steering gearbox, and install the plug screw.

20. Install the floor pan by following the steps described in Chapter 4: Body/Chassis.

21. Install the steering column cover.

22. Test drive the riding mower in a safe area before returning it to service.

23. Install the deck.

Z-Force-S

Rebuilding the steering gear box

To take the steering gear box apart:

1. Remove the steering gear box by following the procedures described in the previous section of this chapter.
2. Remove the drive control link connector plates:
 - 2a. Remove the hairpin clip and clevis pin. See Figure 6.29.

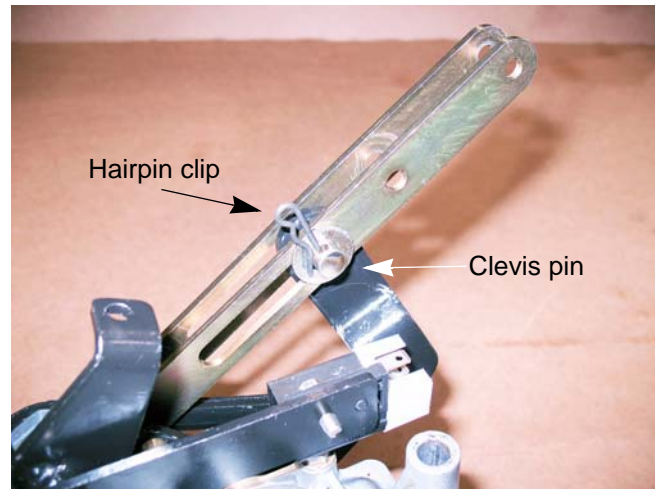

Figure 6.29

- 2b. Remove the nut, while leaving the bolt in place.
 - 2c. Remove the connector plate on the nut side.
 - 2d. Remove the bolt, washers and the roller with the other connector plate. See Figure 6.30.

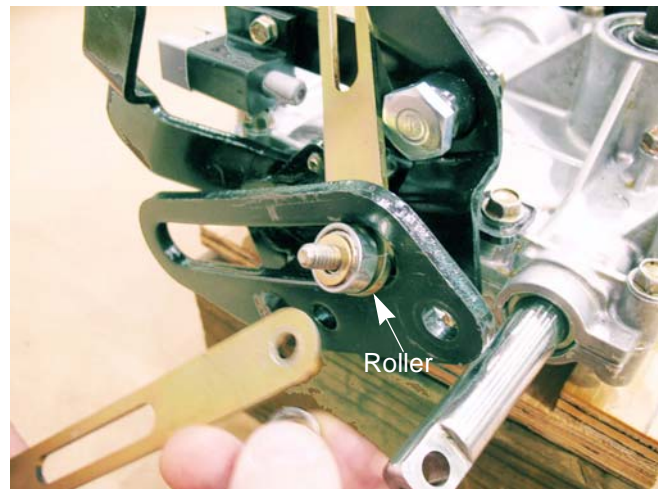

Figure 6.30

3. Remove the brackets from the steering gearbox using a 3/8" wrench. See Figure 6.31.
4. Remove the six remaining case screws using a 3/8" wrench.

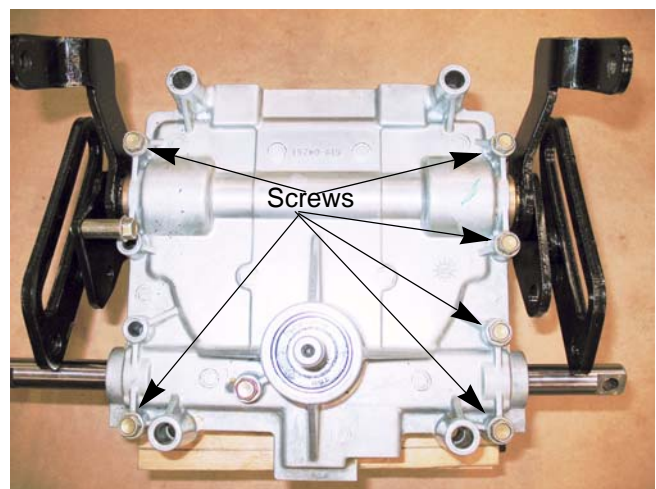

Figure 6.31

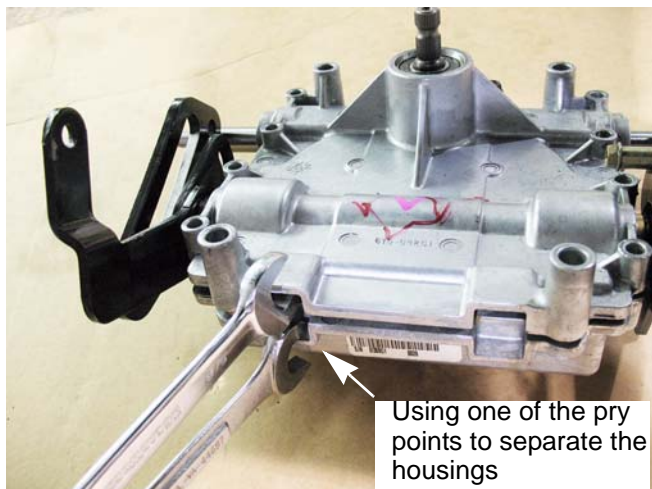

Figure 6.32

5. Lift the upper housing off of the lower housing.

NOTE: There is no sealant between the two housings. They should easily slip apart. If they are stuck together, there are three pry points cast into the housings that can be used to separate the housings. See Figure 6.32.

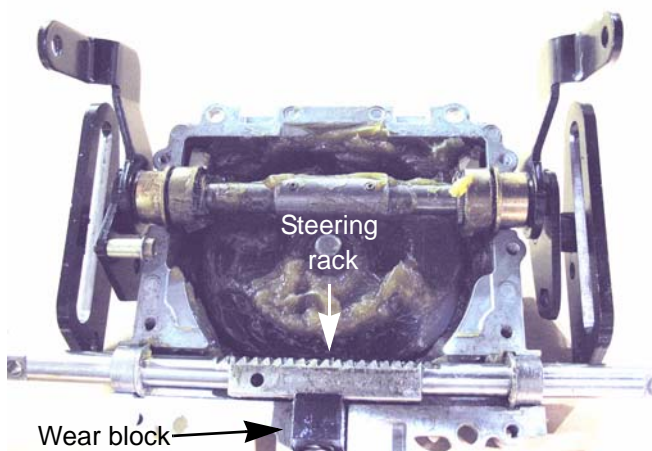

Figure 6.33

6. Remove the steering rack. See Figure 6.33.
7. Remove the wear block and spring.

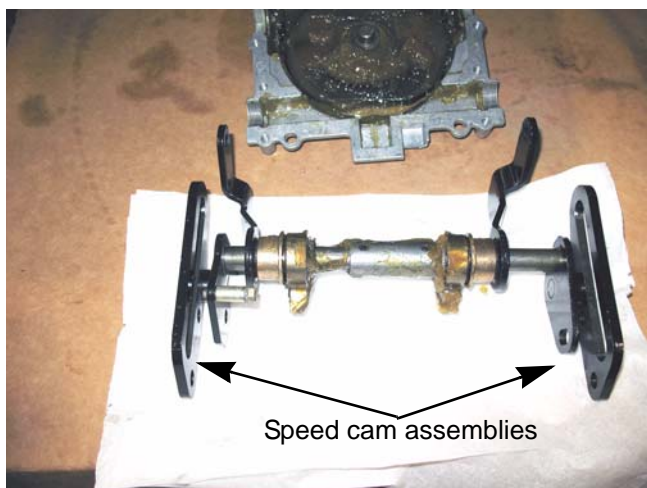

Figure 6.34

8. Remove the speed cam assemblies. See Figure 6.34.

Z-Force-S

9. Separate the speed cam assemblies by driving out the two roll pins using a 5/32" pin punch and a hammer. See Figure 6.35.

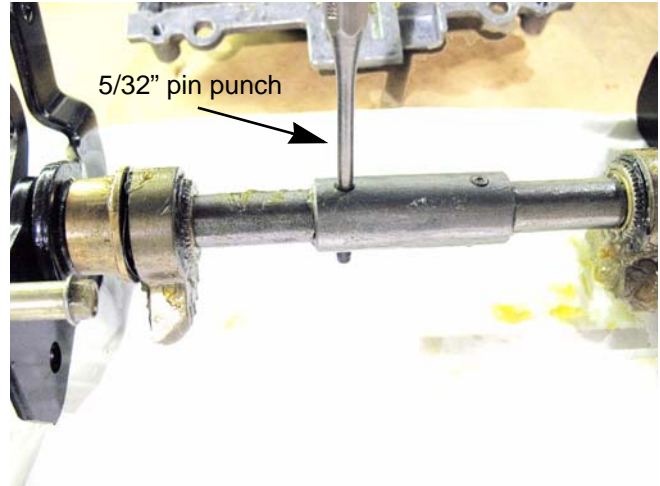

Figure 6.35

10. Slide the output bevel gear assemblies off of the speed cams. See Figure 6.36.

NOTE: Marking the left and right speed cams and the left and right hydro arms will make reassembly easier.

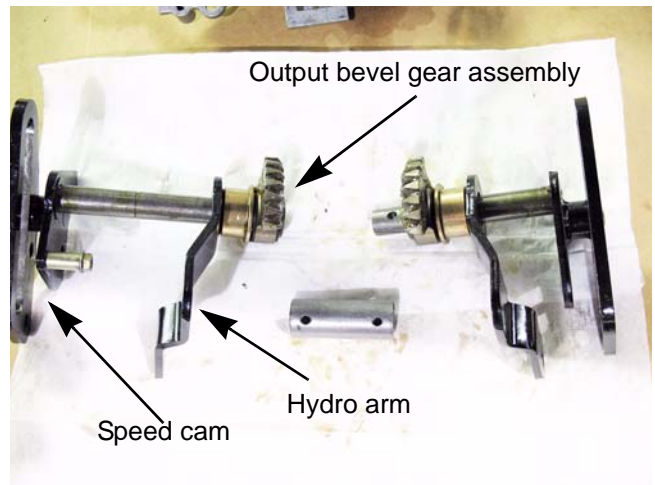

Figure 6.36

11. Separate the output bevel gear assembly by removing the snap ring. See Figure 6.37.

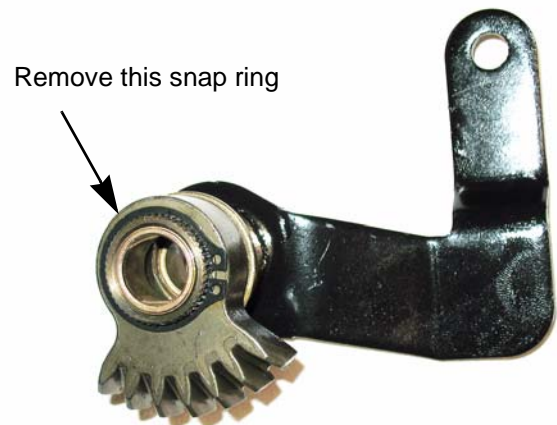

Figure 6.37

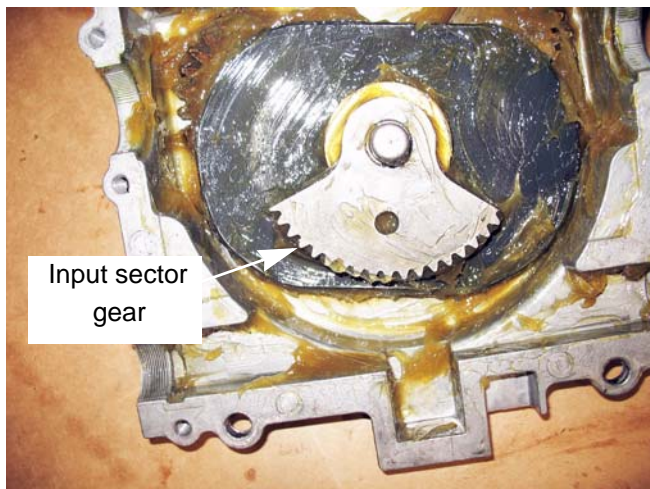

Figure 6.38



Figure 6.39



Figure 6.40

12. Remove the input sector gear. See Figure 6.38.

NOTE: Some gearboxes were built with a spring washer on top of the sector gear. If the sector gear is being replaced, discard the spring washer.

13. Inspect the input sector gear bushings for damage and/or signs of wear. If they show signs of wear or damage, press both of the bushings out of the input sector gear using a press. Then install new bushings. See Figure 6.39.

14. Remove the thick washer. See Figure 6.40.

Z-Force-S

15. Remove the internal cam and the thin washer. See Figure 6.41.

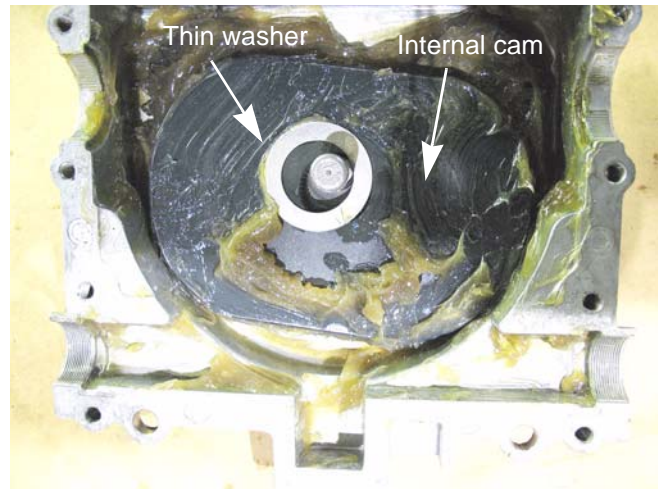

Figure 6.41

16. Remove both of the bevel gears and the washer on the steering shaft. See Figure 6.42.

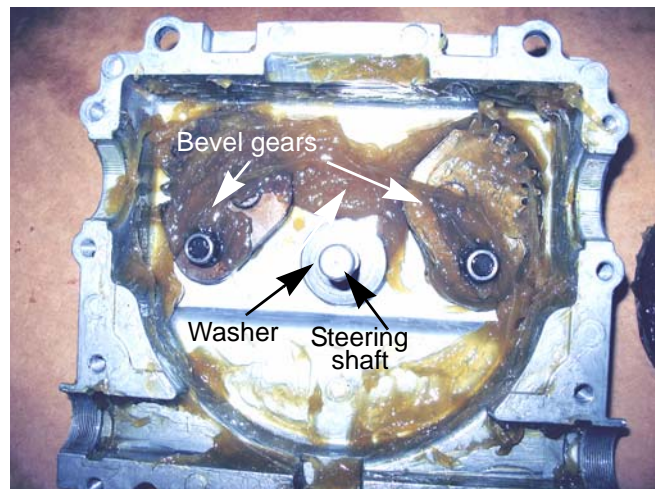

Figure 6.42

17. Remove the snap ring from the input shaft. See Figure 6.43.



Figure 6.43

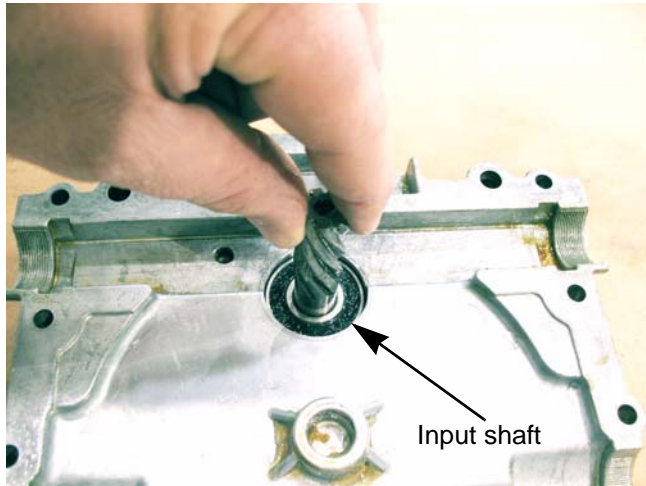

Figure 6.44

18. Remove the input shaft from the inside of the housing. See Figure 6.44.

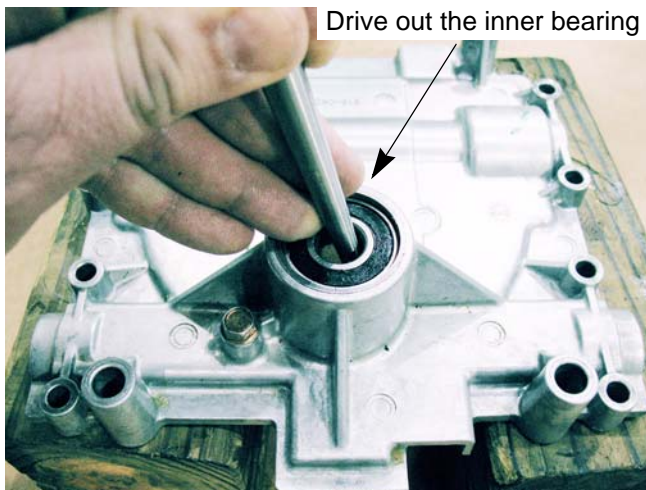

Figure 6.45

19. Inspect the bearings. If they are worn or rough, carefully drive the inner bearing out of the upper housing using a pin punch and hammer. See Figure 6.45.

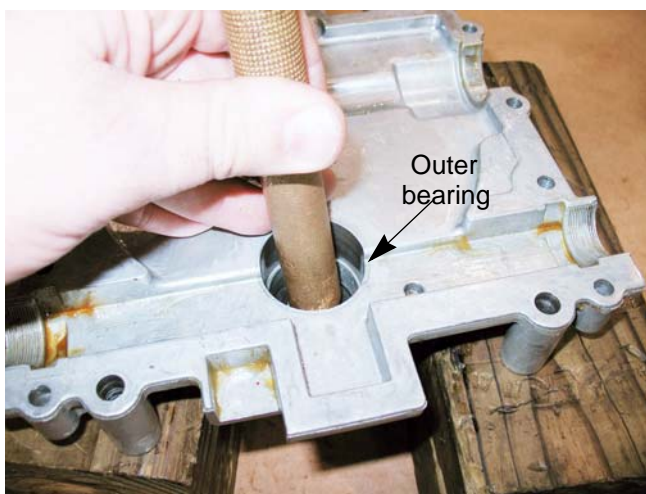

Figure 6.46

20. Drive the outer bearing out of the upper housing using a pin or brass punch and hammer. See Figure 6.46.

21. Thoroughly clean and degrease all parts.

22. Inspect all parts for signs of wear or damage.

NOTE: If the part has signs of wear or damage; discard the part.

NOTE: If the two bushings in the bottom of lower gear box housing are worn, replace the lower housing and press in two new bushings.

Z-Force-S

To assemble the steering gear box:

1. Put a dab of 737-0300A Durina™ grease into each of the bushings in the lower housing. See Figure 6.47.

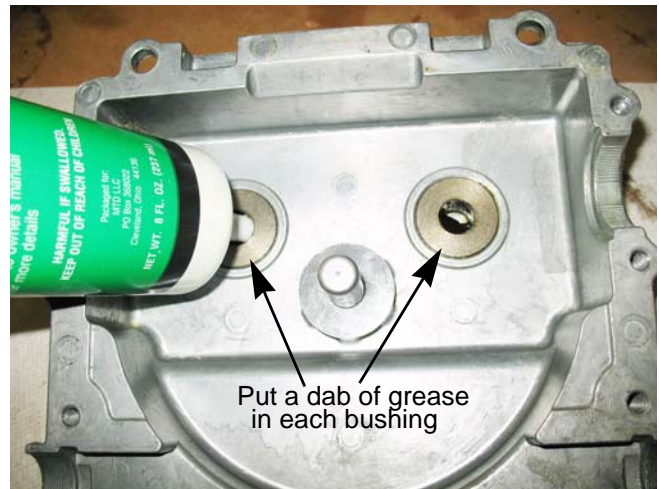

Figure 6.47

2. Install both of the bevel gears with the rollers in-line with the steering shaft. See Figure 6.48.
3. Install the washer on the steering shaft.

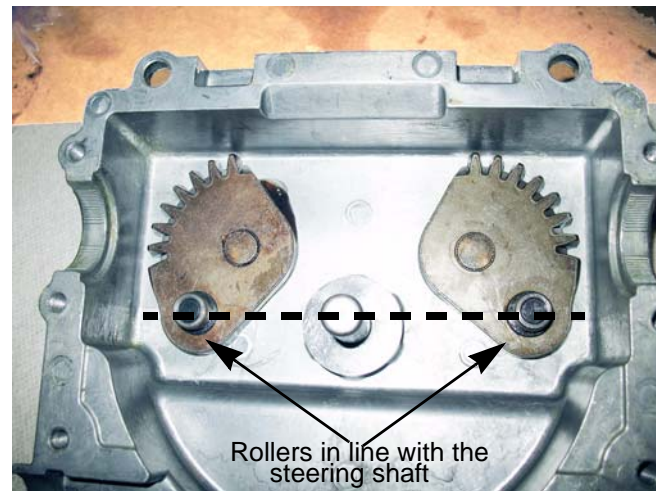

Figure 6.48

4. Place the thick washer over the splines on the sector gear. See Figure 6.49.
5. Place the thin washer on top of the thick washer.
6. Insert the sector gear into the internal cam.

NOTE: There is a master spline on the sector gear and the internal cam to ensure correct timing. See Figure 6.49.



Figure 6.49



Figure 6.50

7. Apply a dab of 737-0300A Durina™ grease to the side of the steering shaft.
8. Install the internal cam so that the rollers on the bevel gears fit inside the grooves on the underside of the cam. See Figure 6.50.

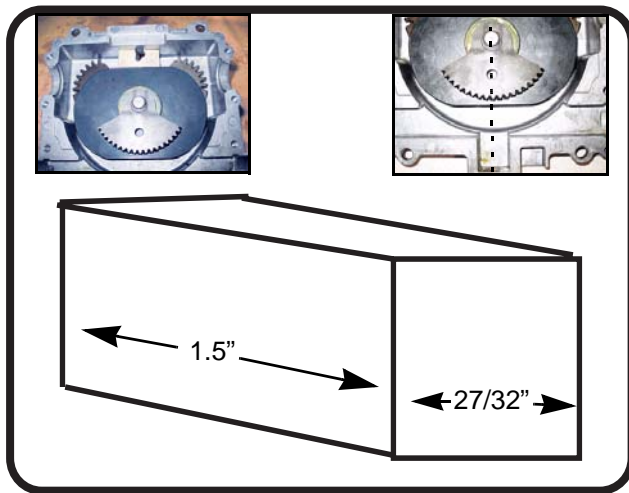

Figure 6.51

9. Center the cam so that the hole in the sector gear lines up with the center of the void where the wear block goes. See Figure 6.51. right inset.

NOTE: A wooden block can be used to hold the cam in place while timing the internal components. The measurements of the block should be $27/32$ " wide x 1.5" long. The height should be at least a $1/2$ ". See Figure 6.51.

NOTE: Putting a screw in the top of the block makes it easier to remove and prevents closing the box with the block still inside. See Figure 6.51. left inset.

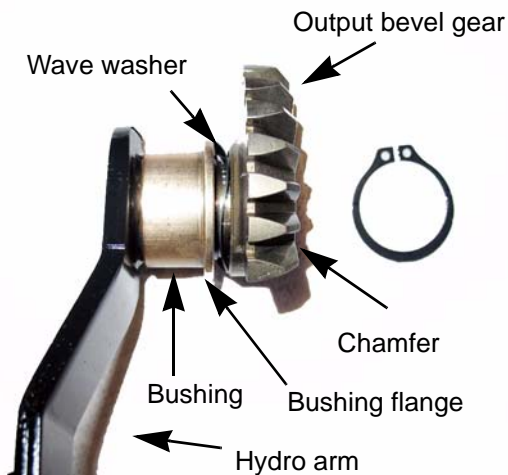

Figure 6.52

10. Re-assemble the output bevel gear assemblies.
 - 10a. Place a bushing over the hydro arm with the flange facing away from the arm. See Figure 6.52.
 - 10b. Place the wave washer over the hydro arm. See Figure 6.52.
 - 10c. Place the output bevel gear on the hydro arm with the chamfer facing away from the hydro arm. See Figure 6.52.

NOTE: If the output bevel gears are put on backwards it will throw off the timing of the gearbox.

Z-Force-S

NOTE: The hydro arms and output bevel gears have master splines to time them to each other. See Figure 6.53.

- 10d. Install the snap ring.
- 10e. Repeat for the right output bevel gear assembly.
- 10f. Slide the bevel gear assemblies onto the speed cam assemblies.

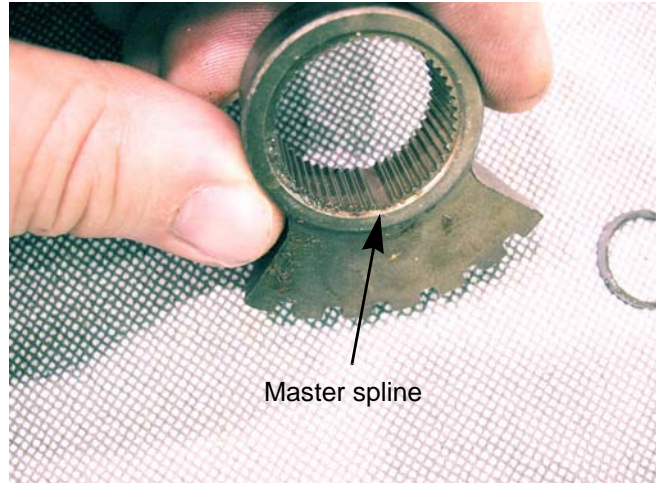

Figure 6.53

- 11. Place both output bevel gear assemblies on the bench, facing each other. With both assemblies resting on the same points of the speed cam, insert both shafts into the coupler. See Figure 6.54.
- 12. Drive the roll pins through the coupler and the shafts to hold the assembly together.

NOTE: The top of the roll pins (as they sit in the steering gearbox) must be flush with the coupler or they will bind against the gearbox cover.

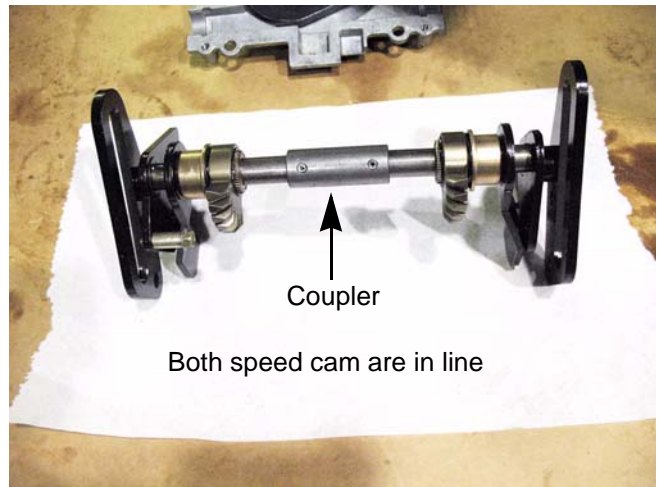

Figure 6.54

- 13. Insert the speed cam assemblies in the lower housing.

- Align the hole in the input sector gear with the center of the square recess at the front of the lower housing. See Figure 6.55.

NOTE: The wooden block from step 9 will hold the cam in place.

- The bevel gears should face away from the input sector gear.
- The first tooth of each output bevel gear should rest in the first valley of the bevel gears in the bottom of the lower housing. See Figure 6.55. inset.

NOTE: If one or both of the output bevel gears are out of time, the steering rack will lose travel on the affected side

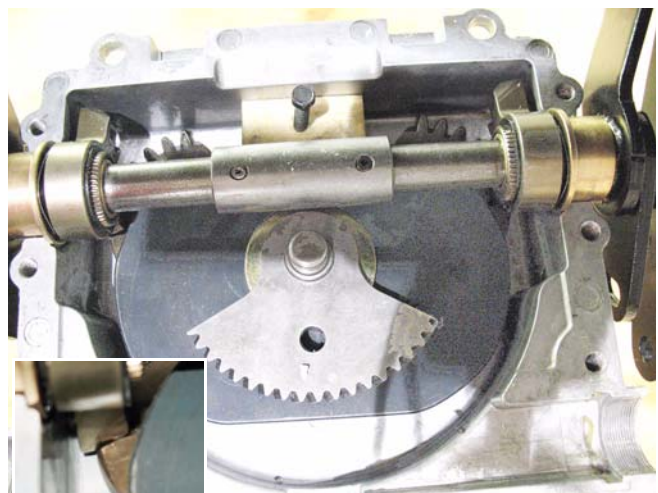

Figure 6.55

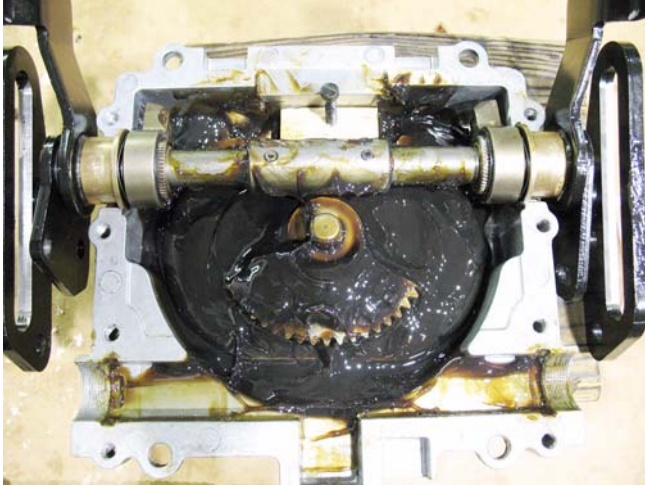

Figure 6.56

14. Fill the lower housing with 12 oz. of 737-0300A Durina™ grease. See Figure 6.56.

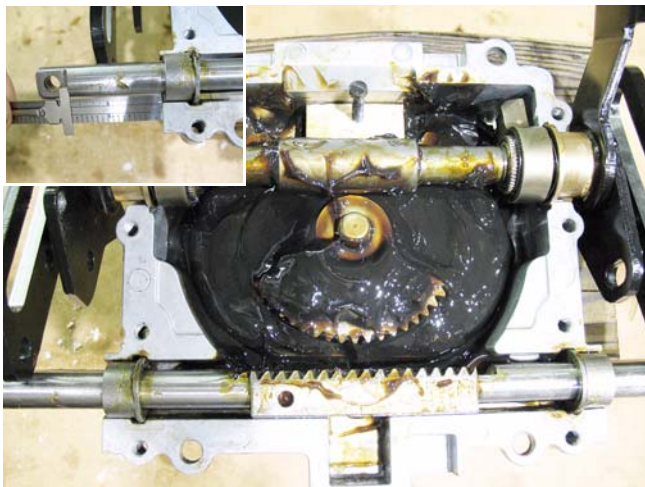

Figure 6.57

15. Install the steering rack and bushings. See Figure 6.57.

NOTE: The rack must be centered. When centered, the rack will measure 1.7" from the shoulder to the housing. See Figure 6.57. inset

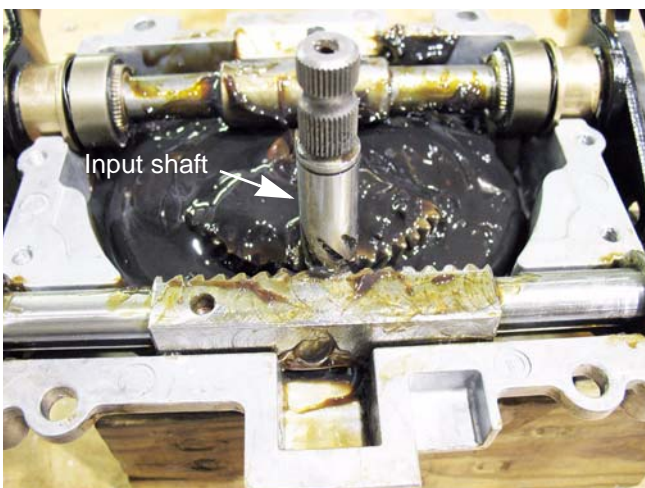

Figure 6.58

IMPORTANT: Before proceeding, test fit the input shaft into the ball bearings for the cover. The input shaft needs to have a slip fit. If it is too tight, clean the shaft with some emery cloth.

16. Install the input shaft so that it is centered with the hole in the sector gear and the center of the void for the wear block. See Figure 6.58.

Z-Force-S

17. Install the wear block and spring. See Figure 6.59.

NOTE: The groove in the wear block faces the bottom of the gearbox housing.

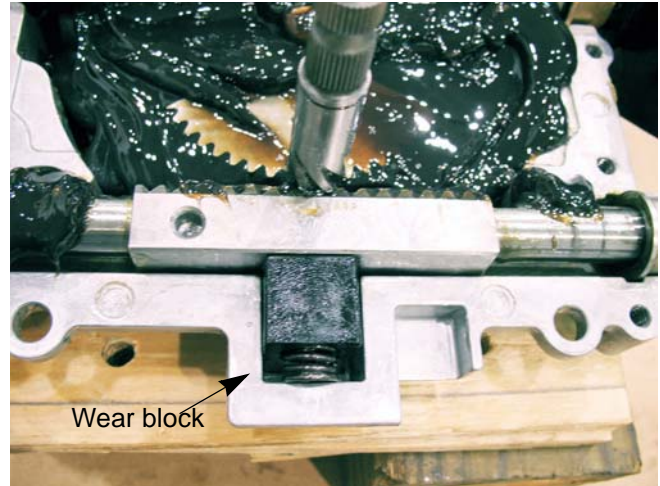

Figure 6.59

18. Press in the upper ball bearing into the upper housing. See Figure 6.60.

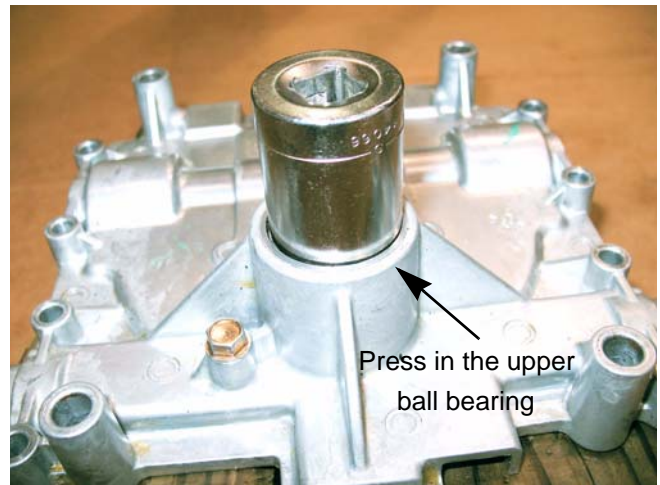

Figure 6.60

19. Press the lower ball bearing into the upper housing. See Figure 6.61.

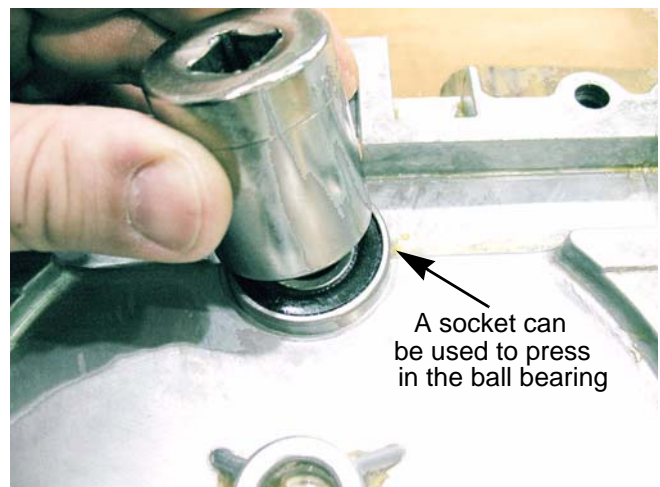

Figure 6.61

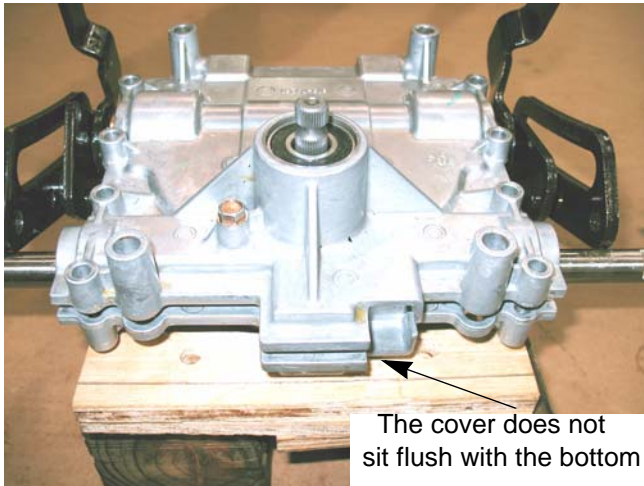

Figure 6.62

NOTE: If used, remove the wooden block first.

20. Lower the gearbox cover straight down over the input shaft.

NOTE: Removal of the screw and spacer on the right speed cam assembly may help.

IMPORTANT: DO NOT force or hammer the cover over the input shaft. That will cause the input shaft to damage the internal cam. If the fit is tight, clean the shaft with emory cloth and try again.

NOTE: The cover will not sit flush with the bottom housing.

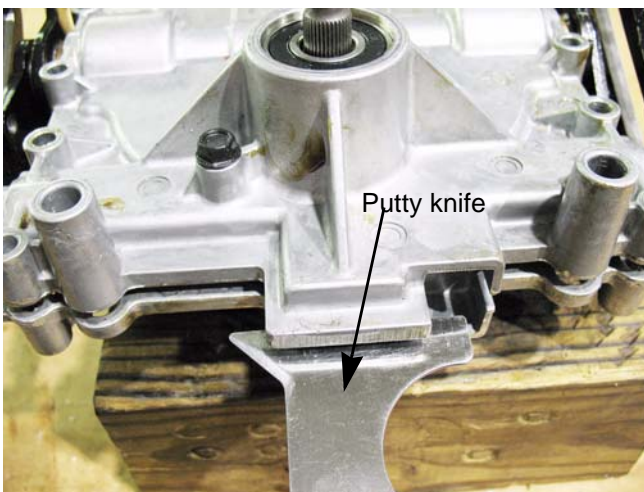

Figure 6.63

21. Using a putty knife or something similar, compress the spring into the wear block while gently pressing down on the cover. See Figure 6.63.

22. While holding the cover in place, test the rack for full range of travel in both directions.

22a. Turn the input shaft until the steering rack has moved all the way to the left. The right shoulder should be flush with the housing.

22b. Turn the input shaft until the steering rack has moved all the way to the right. The left shoulder should be flush with the housing.

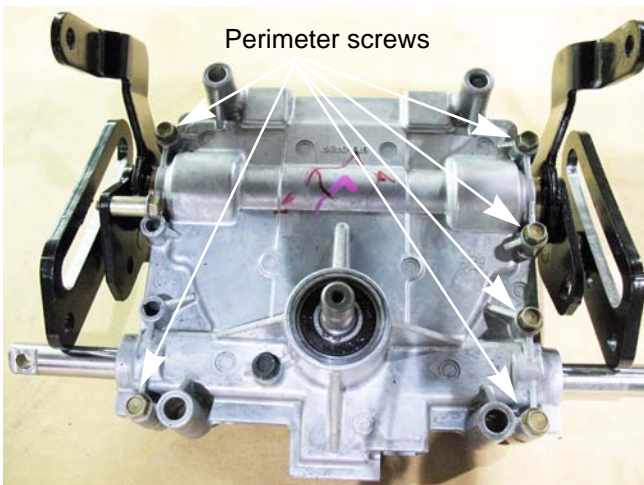

Figure 6.64

23. Install the six perimeter screws using a 3/8" wrench. See Figure 6.64.

Z-Force-S

24. Install the snap ring on the input shaft.
See Figure 6.65.

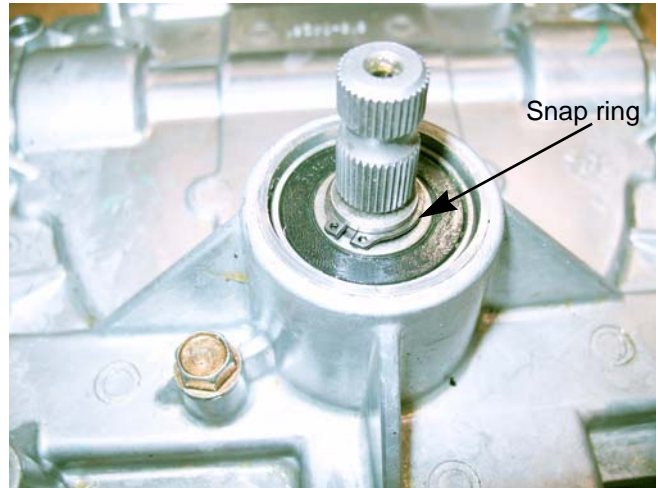

Figure 6.65

25. Install the return to neutral bracket.
26. If the screw and spacer was removed from the speed cam assembly, re-install it.
27. Center the rack and thread a 1/4"-20x2" bolt into the hole in the gear box to lock the gear box in neutral.
28. Install the steering gear box in the mower by following the procedures described in the steering gear-box installation section of this chapter.
29. Test drive the riding mower in a safe area before returning to service.

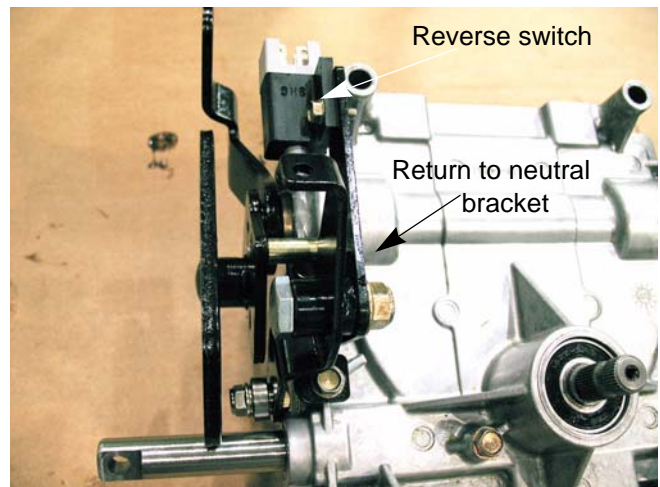

Figure 6.66

Front wheels

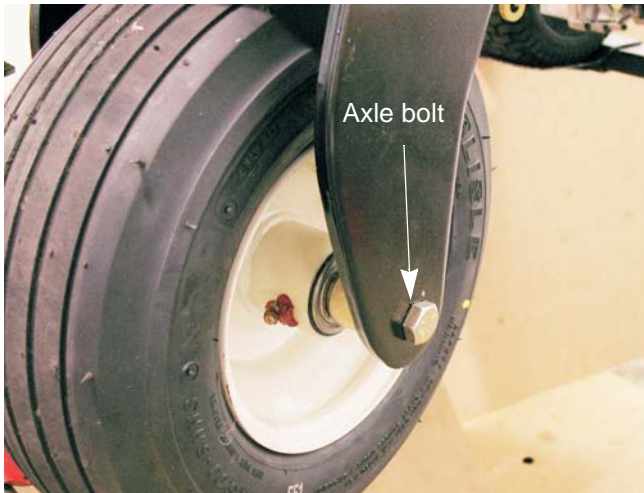

Figure 6.67

Remove/ replace the front wheels:

1. Lift and safely support the front end of the riding mower.
2. Remove the axle bolt and nut using a pair of 3/4" wrenches. See Figure 6.67.

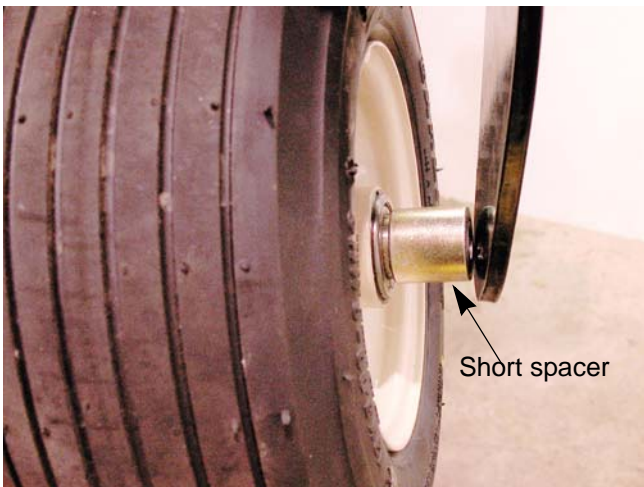

Figure 6.68

3. Slide the tire and wheel assembly out of the yoke. See Figure 6.68.

NOTE: There is a short spacer on each side of the wheel. The short spacers slide over the long spacer that the axle bolt passes through.

4. Slide the long spacer out of the wheel bearings.

NOTE: The long spacer is a tight fit to the bearing and may need to be driven out with a hammer and a brass punch.

5. Install the front wheel by following the previous steps in reverse order.

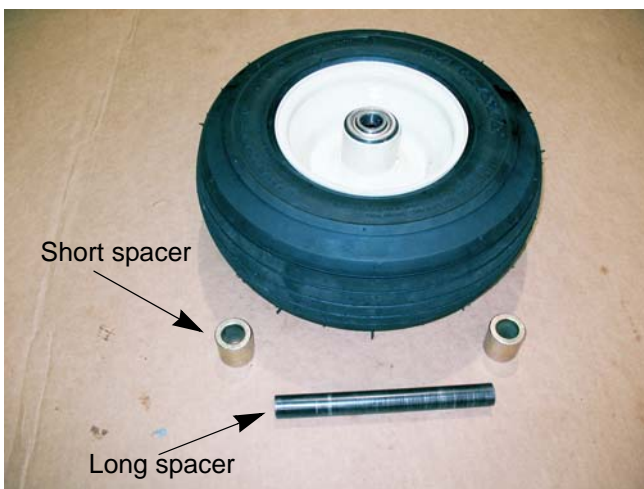

Figure 6.69

Z-Force-S

To replace the front wheel ball bearings:

1. Lift and safely support the front end of the riding mower.
2. Remove the front wheel by following the procedures describe in the previous section of this chapter.
3. Drive the bearings out of the wheel hub using a drift or pin punch. See Figure 6.70.



Figure 6.70

4. Drive in the new bearings using a brass punch or a tube that has the same O.D. as the bearing. See Figure 6.71.
5. Install the front wheel.
6. Pump grease in the grease fitting on the front wheel until it starts to squirt out of the hub.
7. Test drive the riding mower before returning it to service.



Figure 6.71

Front yokes



Figure 6.72

To remove/ replace the front yokes:

- 1 Lift and safely support the front of the riding mower.
2. Remove the front wheel by following the procedures in the front wheel section of this chapter.
3. Pry the yoke cover off using a suitable prying tool. See Figure 6.72.

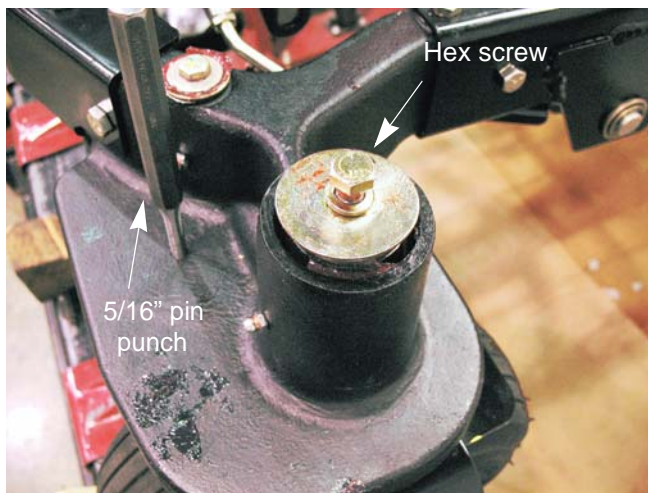

Figure 6.73

4. Align the hole of the inboard steering gear with the hole in the axle casting.
5. Slide a 5/16" lock pin or a pin punch through the hole in the axle casting all the way through the inboard steering gear.
6. Remove the hex screw using a 9/16" wrench. See Figure 6.73.

NOTE: The yoke will slide out as the screw is removed.

7. Remove the washers from the top of the axle casting.

NOTE: If replacing the yoke, remove the steering gear by following the procedures described in the steering gear section of this chapter.



Figure 6.74

To install the yoke:

8. Slide the yoke into the axle casting from the underside.

NOTE: The flat side of the yoke should be parallel with the box section of the frame.

9. Slide the wave washer over the yoke shaft. See Figure 6.74.

Z-Force-S

10. Install the hex screw with a lock washer and the fender washer. See Figure 6.75.
11. Tighten the hex screw holding the yoke to a torque of 31 ft lbs (42 Nm).
12. Install the yoke cover.
13. Install the front wheel by following the procedures described in the front wheel section of the chapter.
14. Test drive the riding mower in a safe area before returning it to service.

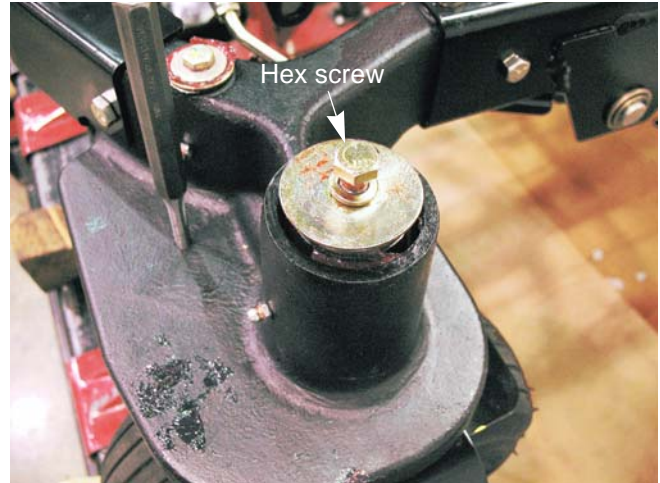

Figure 6.75

Removal of the steering gears



Figure 6.76

To remove the steering gears:

- 1 Remove the four screws that hold the steering column cover in place using a T-30 torx driver. See Figure 6.76.



Figure 6.77

2. Lock the steering gearbox in the centered position:
 - 2a. Remove the 1/4"-20 plug screw from the steering gear box centering port using a 3/8" wrench. See Figure 6.77.
 - 2b. Thread a 1/4"-20x2" bolt into the steering box centering port until you feel it touch the steering rack.
 - 2c. While trying to gently thread the bolt further, slowly rotate the steering shaft back and forth until the bolt seats into the detent in the steering rack.
 - 2d. Finger tighten the screw to set the screw fully into the detent. The steering gear box is now centered and locked.



Figure 6.78

3. Remove the floor pan by following the steps described in Chapter 4: Body/Chassis.
4. Remove the yoke by following the procedures described in the previous section of this chapter.
5. Remove the socket headed cap screw that holds the outboard steering gear to the yoke using a 1/4" hex key. See Figure 6.78.

NOTE: The same gear is used on both yokes. One side is used for the left and it is flipped over for the right. Mark the hole in the yoke that the screw was removed from to help ensure proper orientation when installing the gear. See Figure 6.78.inset.

6. Slide the gear off of the yoke.

Z-Force-S

7. Loosen the jam nuts on both ends of the tie rod(s). See Figure 6.79.

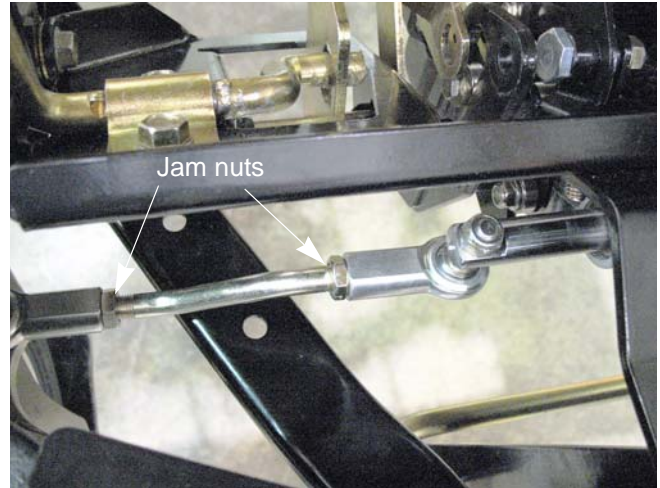

Figure 6.79

8. Disconnect the tie rod end from inboard steering gear using a pair of 1/2" wrenches. See Figure 6.80.



Figure 6.80

9. Remove the hex screw and washer from the top side of the inboard steering gear shaft in place using a 1/2" wrench. See Figure 6.81.

NOTE: A 5/16" lock pin or pin punch can be used to lock the inboard steering gear, unless the gear is broken.

10. Slide the inboard steering gear shaft out of the axle casting.



Figure 6.81



Figure 6.82

11. Remove the hex screw that holds the steering gear to the shaft using a 9/16" wrench. See Figure 6.82.
12. Slide the steering gear off of the shaft.

NOTE: The shaft has a double-D. It may be necessary to drive it off with a hammer.

Z-Force-S

Installation and timing of the steering gears

To install and time the steering gears:

1. Slide the double-D of the steering gear shaft into the double-D hole of the inboard steering gear.

NOTE: The inboard steering gear is the same part number for both sides. If the gear is used on the left hand side, the LH stamped into the gear must be facing the hex screw. If the gear is for the right hand side, the RH must be facing the hex screw. See Figure 6.83.

2. Install the washer and the hex screw to hold the gear to the shaft using a 9/16" wrench.
3. Tighten the hex screw holding the steering gear shaft to a torque of 17 ft lbs (23 Nm).



Figure 6.83

4. Attach the outboard steering gear to the yoke with the socket headed cap screw using a 1/4" hex key. See Figure 6.84.

NOTE: The same gear is used on both yokes. If the gear is used on the left hand side, the LH stamped into the gear must be facing up. If the gear is for the right hand side, the RH must be facing up.

NOTE: The socket headed cap screw acts as the turn stop for the front wheels. Do not replace it with a hex headed screw.



Figure 6.84

5. Slide the inboard steering gear shaft into the axle casting.
6. Install the hex cap screw and washer. See Figure 6.85.
7. Align the hole of the inboard steering gear with the hole in the axle casting.
8. Slide a 5/16" pin punch through the hole in the axle casting all the way through the inboard steering gear. See Figure 6.85.



Figure 6.85



Figure 6.86

9. Slide the yoke into the axle casting from the underside.

NOTE: The flat side of the yoke should be parallel with the box section of the frame.

10. Slide the wave washer over the yoke shaft.



Figure 6.87

11. Install the hex screw with a lock washer and the fender washer. See Figure 6.87.

12. Tighten the hex screw holding the yoke to a torque of 31 ft lbs (42 Nm).

13. Attach the tie rod end to the inboard steering gear. Use a pair of 1/2" wrenches to tighten the nut and bolt.

NOTE: If necessary, adjust the tie rod ends so that the hole in the rod end lines up with the hole in the steering rack.

14. Remove the 5/16" pins.

15. Install the yoke cover.

16. Remove the locking bolt from the steering gearbox, and install the plug screw.

17. Install the floor pan by following the steps described in Chapter 4: Body/Chassis.

18. Install the steering column cover.

19. Test drive the riding mower in a safe area before returning it to service.

Z-Force-S

Tie rods

To remove/replace a tie rod:

1. Lift and safely support the front of the mower.
2. Remove the four screws that hold the steering column cover in place using a T-30 torx driver. See Figure 6.88.

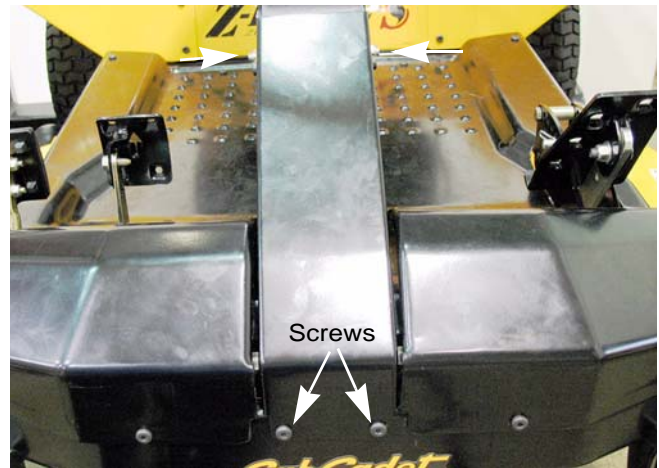

Figure 6.88

3. Lock Steering Gear Box in Neutral Position:
 - 3a. Remove the 1/4"-20 plug screw from the steering gear box centering port using a 3/8" wrench. See Figure 6.89.
 - 3b. Thread a 1/4"-20x2" bolt into the steering box centering port until you feel it touch the steering rack.
 - 3c. While trying to gently thread the bolt further, slowly rotate the steering shaft back and forth until the bolt seats into the detent in the steering rack.
 - 3d. Finger tighten the screw to set the screw fully into the detent. The steering gear box is now centered and locked.

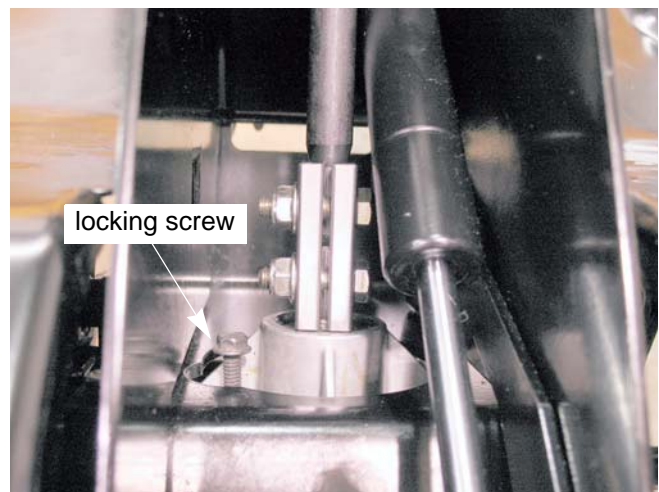

Figure 6.89

4. Loosen the jam nuts on both ends of the tie rod using a 9/16" wrench. See Figure 6.90.

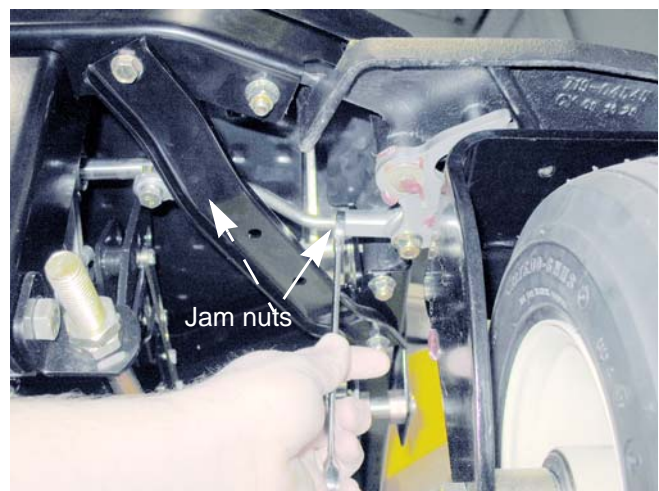

Figure 6.90

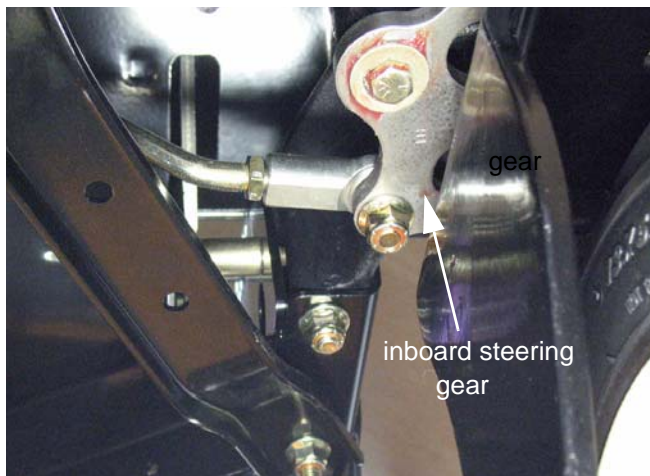

Figure 6.91

5. Disconnect the tie rod end from inboard steering gear using a pair of 1/2" wrenches. See Figure 6.91.

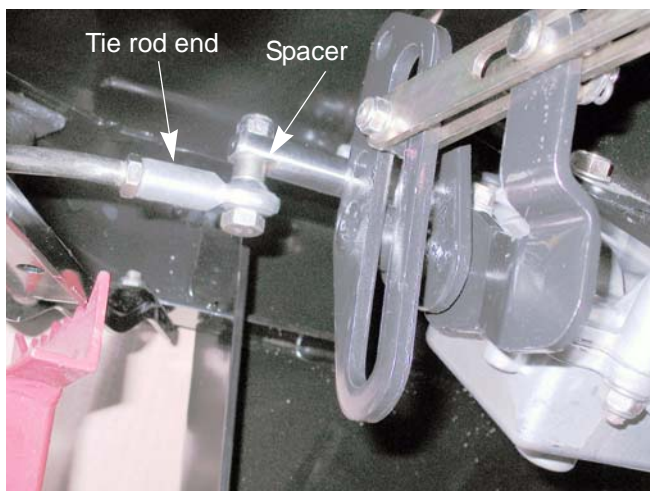

Figure 6.92

6. Disconnect the tie rod end from the steering gearbox using a pair of 1/2" wrenches. See Figure 6.92.

NOTE: There is a spacer between the tie rod end and the steering rack.

7. Remove the tie rod from the mower.

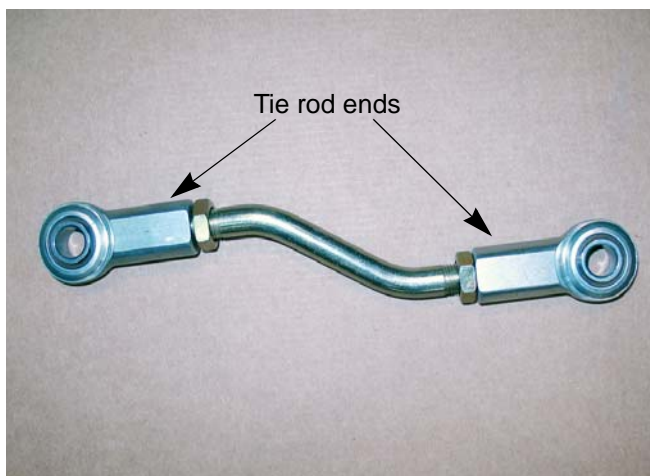

Figure 6.93

8. Remove the tie rod ends. See Figure 6.93.

NOTE: Count the number of turns to remove the spherical rod ends.

9. Install new tie rod ends.

NOTE: Install the tie rod ends the same number of turns as it took to remove them from the old tie rod.

NOTE: Leave the jam nuts loose.

10. Install the tie rod on the riding mower.

Z-Force-S

11. Manually move the front wheel yoke until the alignment holes line up.
12. Insert the 5/16" pin.
NOTE: The flat side of the yoke should be parallel to the box section of the frame when the pins are installed.



Figure 6.94

13. Adjust the tie rods until the ends line up with their mounting point. See Figure 6.95.
14. Attach the tie rod to the steering rack.
NOTE: The spacer must be between the tie rod end and the steering rack.
15. Attach the tie rod to the inboard steering gear.
16. Tighten the jam nuts.
17. Remove the 1/4"-20x2" screw from the steering gear box.
18. Reinstall the original plug screw in the steering gear box.
19. Install the steering column cover.
20. Remove the 5/16" pins.
21. Test drive the riding mower in a safe area before returning it to service.



Figure 6.95

Steering shaft, bushings and dampener removal



Figure 6.96

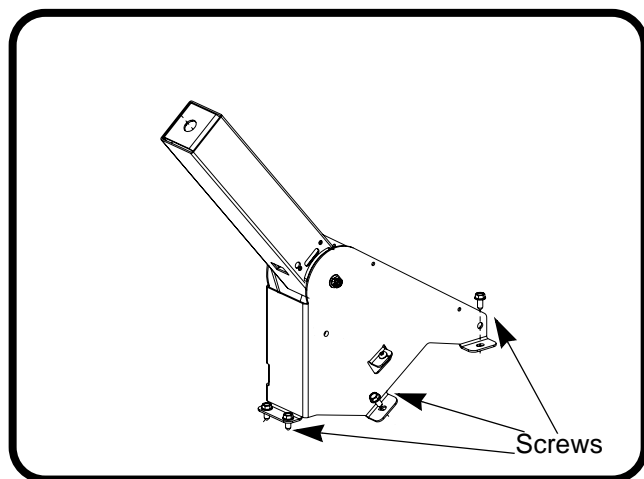

Figure 6.97

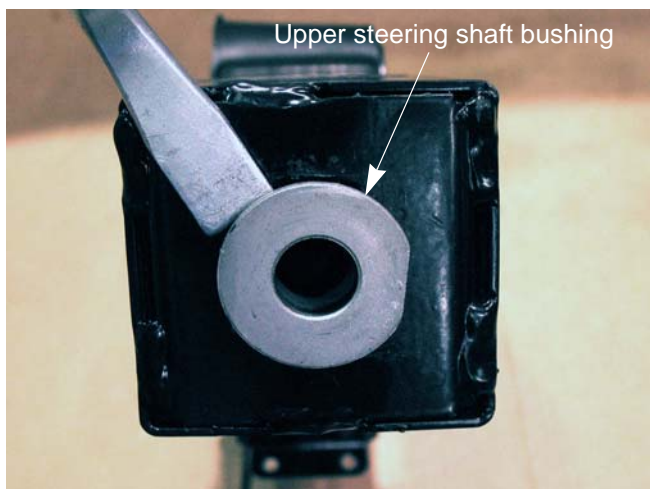

Figure 6.98

To remove the steering shaft:

- 1 Remove the floor pan by following the steps described in Chapter 4: Body/Chassis.
- 2 Remove the four screws that hold the steering column cover in place using a T-30 torx driver.
- 3 Remove the steering wheel using a 1/2" wrench.
- 4 Loosen the top clamp bolt in the steering shaft coupler using a pair of 1/2" wrenches.
- 5 Remove the bottom bolt in the steering shaft coupler. See Figure 6.9.

NOTE: Do not lock the steering gearbox at this time.

- 6 Remove the six screws that hold the steering column to the frame using a 1/2" wrench. See Figure 6.97.
- 7 Lift the steering column assembly off of the mower.

- 8 Remove the steering shaft from the bottom of the steering column.
- 9 Remove the upper steering shaft bushing. See Figure 6.98.

Z-Force-S

10. Remove the lower steering shaft bushing.

NOTE: The long half of the steering shaft can be inserted through the upper bushing hole and used to tap out the lower bushing.



Figure 6.99

To remove the steering column dampener:

11. Remove the steering column dampener pivot bolts using a 9/16" wrench and a 3/4" wrench. See Figure 6.100.

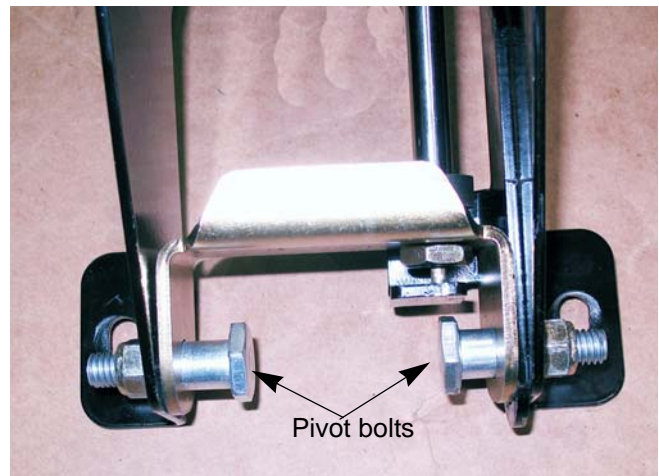

Figure 6.100

12. Remove and discard the cotter pin that secures the end of the dampener to mounting post inside the steering column. See Figure 6.101.
13. Slide the dampener off of the mounting post.



Figure 6.101

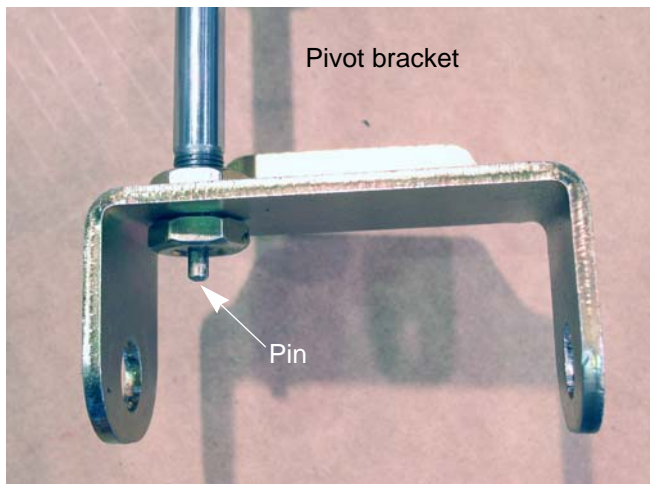

Figure 6.102

14. Remove the pivot bracket from the dampener using a pair of 17 mm wrenches. See Figure 6.102.

NOTE: This dampener has a locking feature. The pin extending from the threaded end of the dampener releases the dampener so that it can extend or retract. See Figure 6.102.

Z-Force-S

Steering shaft, bushings and dampener installation

1. Attach the pivot bracket to the end of the dampener using a pair of 17 mm wrenches. See Figure 6.103.

NOTE: Apply a small amount of releasable thread locking compound such as Loctite® 242 (blue) to the threads of the dampener.

NOTE: The outer nut should be flush with the end of the threaded portion of the dampener.

NOTE: This dampener has a locking feature. The pin extending from the threaded end of the dampener releases the dampener so that it can extend or retract. See Figure 6.103.

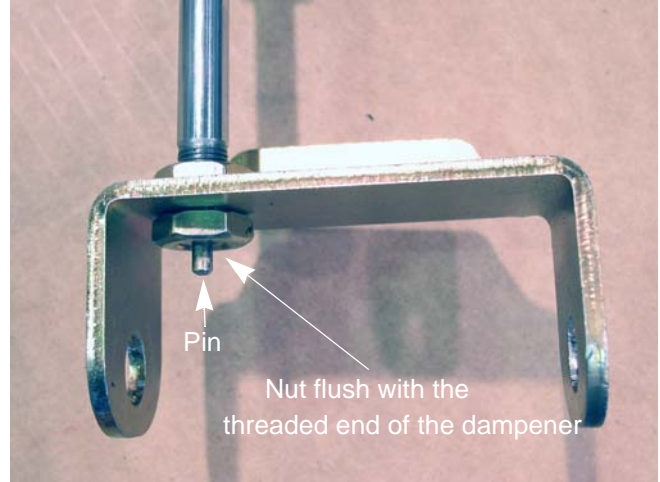

Figure 6.103

2. Slide the end of the dampener over the mounting post inside the steering column.
3. Install a new cotter pin. See Figure 6.104.

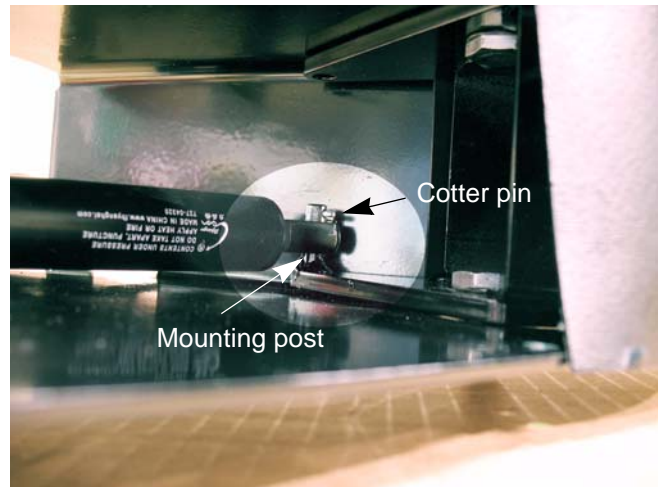

Figure 6.104

4. Slide a bushing onto the long end of the steering shaft. See Figure 6.105.

NOTE: The flange must face the universal joint.

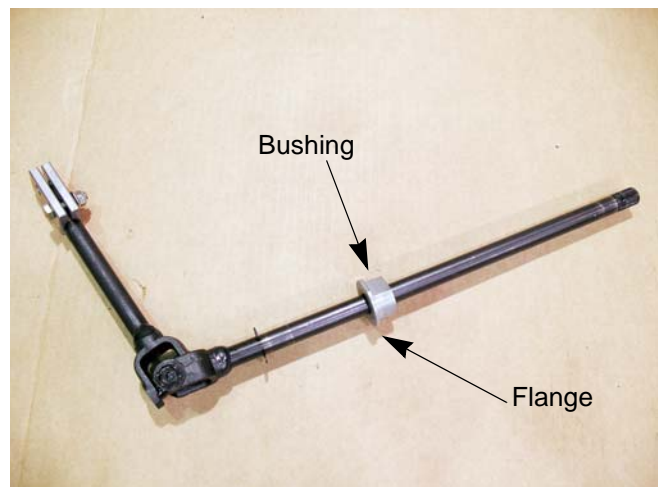

Figure 6.105

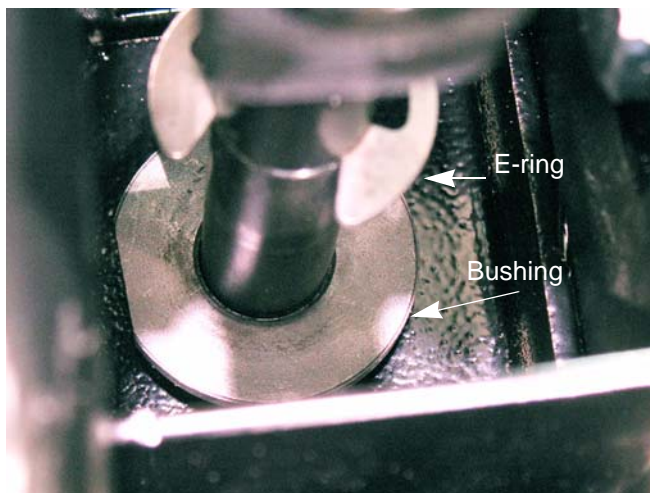

Figure 6.106

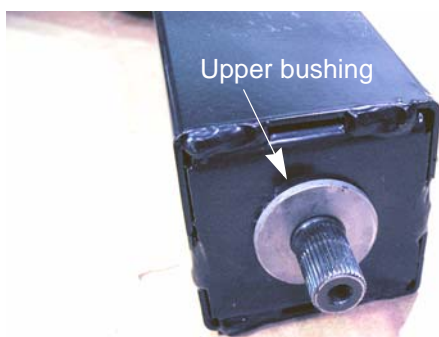

Figure 6.107

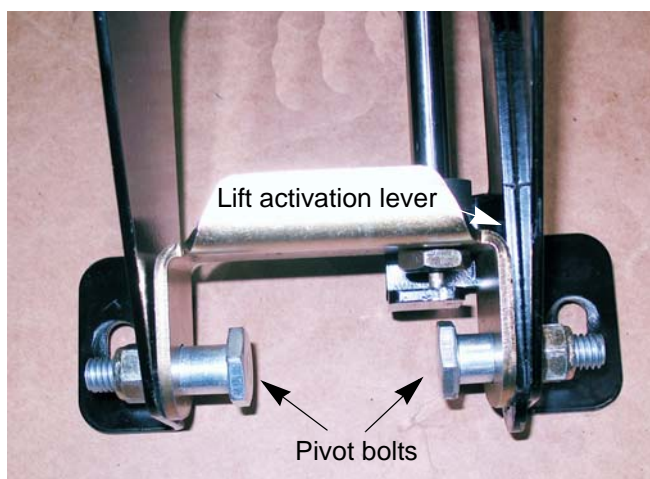

Figure 6.108

5. Slide the steering shaft and bushing into the bottom of the steering column.
6. Align the bushing with the hole in the steering column.
7. Tap the bushing in place using the E-ring on the steering shaft. See Figure 6.106.

8. Install the upper bushing into the top side of the steering column. See Figure 6.107.

9. Install the steering column dampener pivot bolts using a 9/16" wrench and a 3/4" wrench. See Figure 6.108.

NOTE: Make sure the shoulder of the lift pivot bolt passes through the lift activation lever.

Z-Force-S

10. Lower the steering column assembly onto the frame of the mower.

NOTE: Slide the steering shaft coupler over the input shaft of the steering gearbox while lowering the steering column in place. See Figure 6.109.

11. Install the lower coupler bolt.
12. Tighten both of the coupler bolts with a pair of 1/2" wrenches.

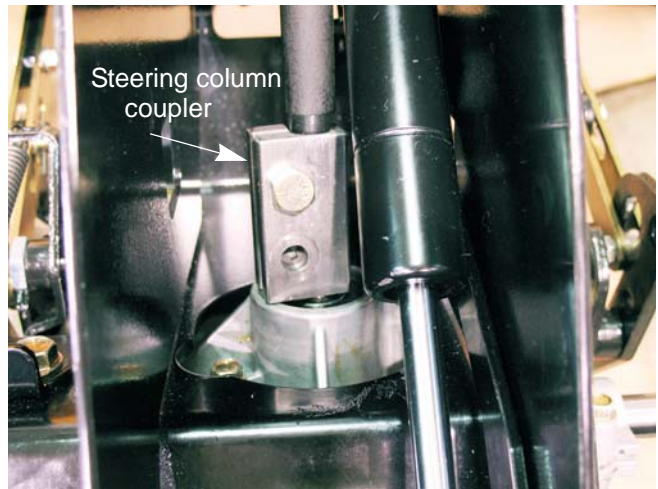

Figure 6.109

13. Install the six screws that hold the steering column to the frame. See Figure 6.110.
14. Install the floor pan by following the procedures described in Chapter 4: Body.
15. Install the steering column cover.

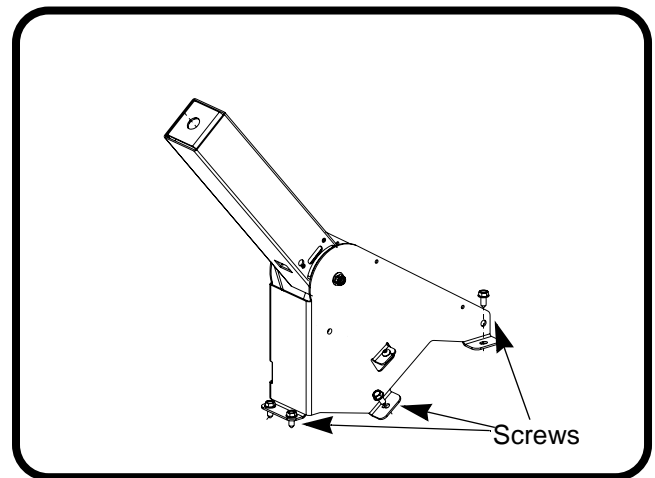

Figure 6.110

16. Align the holes in the axle castings with the holes in the steering gears.
17. Install a pair of 5/16" pins in the holes. See Figure 6.111.



Figure 6.111



Figure 6.112

18. Center and install the steering wheel.
19. Tighten the steering wheel screw using a 1/2" wrench. See Figure 6.112.
20. Remove the 5/16" pins.
21. Test drive the mower in a safe area.

CHAPTER 7: ELECTRICAL SYSTEM

Introduction

This chapter is divided into four sections:

- **Section 1:** About this chapter and precautions
- **Section 2:** Components
 - This section will describe the location and operation of the electrical components on the mower. Where appropriate, some disassembly or component removal instructions will be included.
- **Section 3:** Diagnostic Techniques
 - This section will cover basic tools, techniques, and methodology for diagnosing electrical issues on the mower. A lot of the information in this section can be applied to other equipment.
- **Section 4:** Schematics



Before disconnecting any electrical component, take precautions to prevent the component or the wires attached to it from shorting out. The most effective means of doing this is to disconnect the battery ground cable from the negative battery terminal. Unless performing tests that require the electrical system to be in operation, disconnect the negative cable from the battery before doing any work to the electrical system of the mower.

Components

The Z-Force-S has the same Cub Cadet Rev-Tek system used on the 1000 series tractors.

RMC Module

The **RMC module contains electronic logic circuits**. When diagnosing anything that is connected to the RMC module, a high impedance test light or a high impedance digital multi-meter (DMM) must be used. The amperage draw of a standard incandescent test light may over-burden some internal electronic circuits, burning out the module.

NOTE: These tools are not outrageously expensive or exotic. High impedance test lights (Thexton model 125 is typical) can be purchased locally from stores like NAPA for under \$30.00. Appropriate multi meters can be purchased for under \$100.00, and are an invaluable tool for any competent technician.

- It is typical when industries shift from electromechanical to electronic controls that diagnosis shifts from tracing through a number of independent circuits to checking the in-puts to and out-puts from a central processor. This is similar to, but much less complex than the transition that the auto industry made with the conversion to fuel injection in the 1980s.

NOTE: The starter safety circuit has no connection to the RMC module.

- It is still important to be familiar with the workings of the individual components of the electrical system, but some of them can now be checked from a central point on the mower. This makes life easier on the technician, frequently making it unnecessary to connect to difficult to reach switches in the preliminary stages of diagnosis.
- The function of individual safety switches can be seen as providing information “inputs” to the RMC module.
- The next part of this section gives a detailed description of the electrical components on this mower, their function in the system, and their physical location on the mower. Armed with this information and the proper tools, a technician should be able to efficiently diagnose most electrical problems.

Z-Force-S

Key switch

The Key Switch is similar to those used in a variety of MTD applications since 1999. The difference, in this case, is that it is incorporated in the same housing as the RMC module; the two items are not available separately. See Figure 7.1.

1. In the **OFF** position, continuity can be found between the M, G, and A1 terminals. See Figure 7.2.
 - M is connected to the magneto by a yellow wire, G is connected to ground by a green wire, and A1 is connected to the after fire solenoid.

NOTE: In the **OFF** position, the magneto primary windings are grounded, disabling the ignition system. The after fire solenoid loses its power from the B terminal. This turns off the fuel supply.

- **Symptom:** engine runs with key in OFF position: The key switch is not completing the path to ground either because of an internal fault or a bad ground connection elsewhere in the harness. Check continuity between M, G, and A1 terminals with key switch in OFF position. Check the green wire for continuity to ground.
- **Symptom:** loud "BANG" when key is turned to the OFF position: The after fire solenoid is not closing, either because it is physically damaged or the power is not being turned off. Check for power at the solenoid. Check continuity between G and A1 terminals. Check for no continuity between A1 and the B terminals.

NOTE: If the engine is at an idle when the key is turned off, fuel is drawn into the engine through the idle ports of the carburetor by-passing the fuel shut off solenoid. The raw fuel will travel through the engine and ignite in the muffler causing an after fire.

- **Symptom:** Engine runs 3-5 seconds after key is turned to OFF position: The after fire solenoid is turning off the fuel supply, but the ignition is continuing to operate. Check continuity between the M and G terminals in the OFF position. Check continuity from yellow wire connection all the way to the spade terminal on the magneto.
2. In the **START** position, continuity can be found between B, S, and A1 terminals.
 - Battery power from the B terminal is directed to the start circuit through the S terminal and to the after fire solenoid through A1.
 - **Symptom:** No crank and no starter solenoid click: Power is not getting to the trigger spade on the starter solenoid. Test for a good battery then check for power where the fused red wire with white trace connects to the B terminal. Check for continuity between B and S terminals in START position. If power is getting to the S terminal in the START position, the problem lies down-stream in the starter circuit, Check continuity from the orange wire on the S terminal to the orange wire with white trace on the trigger spade on the starter solenoid. If it is broken, trace through the parking brake and PTO switches.
 - **Symptom:** No crank, solenoid click: The problem lies in the heavy-gauge side of the starter circuit; low battery voltage, battery cables, starter cable, solenoid, or ground issue.

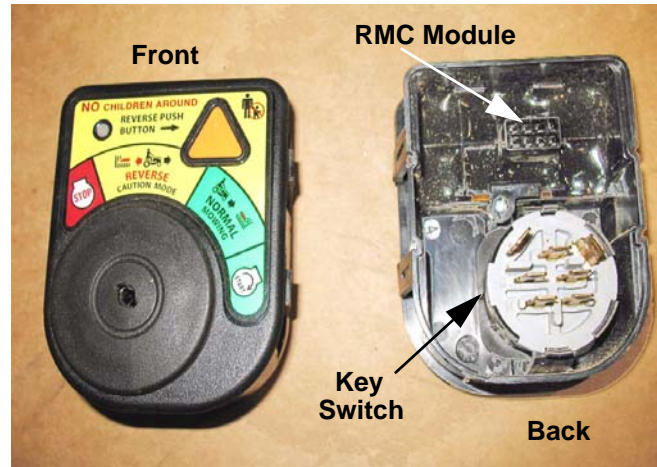

Figure 7.1

Key switch schematic

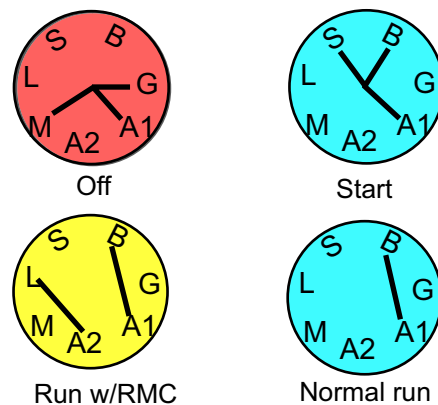

Figure 7.2

- **Symptom: Crank, spark, but no fuel:** First check the fuel tank to verify that there is fuel in it. If there is fuel in the fuel tank, test for power at the after fire solenoid. If there is no power there, then check for continuity from B to A1 in the START position. If power is reaching the red wire that connects to the A1 terminal in the start position, the problem lies down stream of the key switch. A handy quick-check is to apply power to the red wires where they connect to the S terminal (whole circuit) or directly to the after fire solenoid to listen for the audible “click” that it makes when functioning.
 - **Symptom: Crank, but no spark:** This is a highly unlikely scenario. If it occurs after a key switch has been changed independently of the RMC module, this would arouse suspicion that the wrong key switch was installed. Otherwise, the problem lies elsewhere in the safety circuits or engine. Do not over look the possibility of a bad magneto or chafed ground lead within the engine harness.
3. In the **NORMAL RUN** position (green zone), the B and A1 terminals should have continuity. Once the engine is running, the alternator produces current that tracks-back to charge the battery, via the red wire connected to the B terminal.
- **Symptom: Battery does not charge:** Follow the engine manufacturer’s recommendations for testing alternator output. If alternator output is getting to and through the key switch, but not reaching the battery, the fuse may have blown after start-up. A blown fuse will disable the starter circuit. A simple quick-test for the presence of alternator output at the battery is to check across the battery posts for DC voltage.
 - **Symptom: After fire solenoid does not work: engine starts and dies:** The after fire solenoid is powered directly by the red wire with a white trace from the A1 terminal of the key switch, and should operate independently of anything else on the mower once the engine is running. If the alternator fails *and* battery power is not reaching the after fire solenoid through the key switch, it will not work. This is an unusual set of circumstances.
4. In the **REVERSE CAUTION MODE** (yellow zone), the same characteristics are true as for the normal run position, but *in addition* the L terminal will have continuity with the A2 terminal. The A2 terminal is connected to the RMC module by a purple wire. The L terminal (formerly used for the lighting circuit) connects directly to the ground circuit of green wires. When the key is in the REVERSE CAUTION MODE position, the purple wire carries a ground signal to the RMC module. When the seat is occupied, this ground signal arms (enables), *but does not turn on* the RMC module.
- **Symptom: RMC module will not turn on:** Check for continuity between A2 and L terminals on the key switch when it is in the REVERSE CAUTION MODE position. Confirm that the green wire has continuity to ground. If the switch is capable of establishing a ground signal to the RMC module, the problem is likely to lie elsewhere in the system.
 - **Symptom: RMC module will not turn on:** confirm that the ground path (continuity to ground) to the purple wire is broken when the key switch is in any position other than REVERSE CAUTION MODE.
 - The RMC module is disarmed (disabled) when the seat is empty. To re-arm the module, the key is moved to another position, breaking the ground signal, then returned to the REVERSE CAUTION MODE, re-establishing the ground signal. It works something like a latched relay. If it is not possible to break the ground-path, it is not possible to freshly establish it either, and the RMC module will not be armable.
 - Causes for such a condition might include a shorted or incorrect key switch, or a chafed purple wire shorting to ground between the key switch and the RMC module.

Z-Force-S

RMC Module

The RMC Module is in the same housing as the key switch, and is not available separately. For the purpose of diagnosis, it is treated separately. Diagnosis of the module with the key switch introduces too many over-lapping variables. See Figure 7.3.

- **Principle:** To diagnose the module, the simplest approach is to check all of the inputs (safety circuits) that are connected to it. If the inputs work properly, but the RMC module does not work properly (outputs), then the module can be determined to be faulty. A specific procedure is covered, following the description of the correct operation of the RMC module.
- **Working properly:** The module cannot be diagnosed if its function is not understood. It is designed to work as follows: See Figure 7.4.
- When the **RMC module is disarmed**, the mower will operate as MTD mowers have historically operated:
 - If reverse is engaged when the electric PTO is ON, the PTO clutch will turn off.
 - If the operator leaves the seat with the engine running, the engine will turn off.
 - If the operator leaves the seat with the PTO in the OFF position, the engine will turn off unless the parking brake is applied.
- When the RMC module is armed, the mower will operate identically to when the module is disarmed.
- When the **RMC module is armed** and turned on: The mower will operate identically to when the module is disarmed, except that the operator will be able to put the transmission in reverse with the PTO engaged and the cutting deck will continue to run. The operator may put the mower into and out of reverse as many times as they wish without having to re-arm or turn on the module again.
- **To arm the RMC module:** The operator must turn the key switch to the REVERSE CAUTION MODE (yellow zone), while sitting in the operator's seat.
- **To turn the RMC module ON:** The module must first be armed, then the orange triangular button is depressed, illuminating the red LED indicator to indicate that it is ON. It is important that the operator must take two actions to turn the RMC module ON so that they do not do so inadvertently.
- **The RMC module will turn OFF and disarm if:** The operator moves the key to any position other than REVERSE CAUTION MODE or gets out of the seat. If the operator leaves the seat without setting the parking brake, the engine will turn off. The key movement necessary to re-start the engine will make it necessary to re-arm and turn on the RMC module if the operator wishes to continue with the ability put the mower in reverse while the PTO is running.
- **To re-arm and turn the module ON:** If the key is in REVERSE CAUTION MODE position, it must be turned to another position (Normal Run), then returned to REVERSE CAUTION MODE. Once re-armed, the module can be turned on by pressing the orange triangular button. It will be confirmed that the module is ON by the illumination of the red LED on the module.

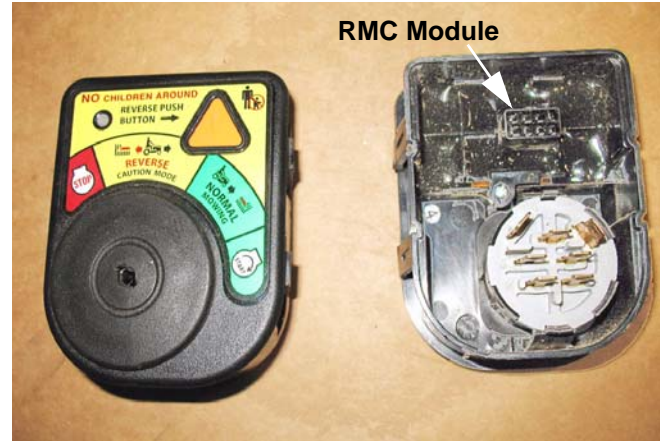

Figure 7.3



Figure 7.4

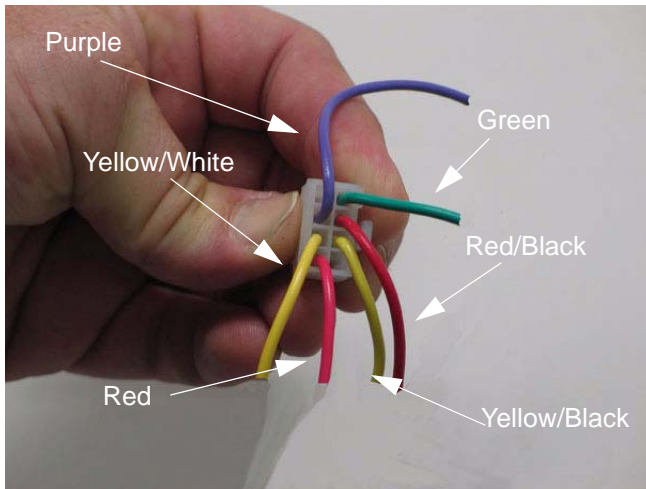

Figure 7.5



Figure 7.5

To identify a faulty RMC module:

If the RMC module does not function as described, the RMC plug test should be the first step in diagnosis.

- If the RMC plug test confirms that the safety circuits (inputs) work as designed, yet the RMC module does not work properly, the RMC module is faulty.
- The RMC plug test will give an indication of what the problem is if it is not a faulty RMC module. If the problem is identified in a particular circuit, check the safety switch that is associated with that circuit. If the switch is good, then the problem lies within the wiring harness.

NOTE: Like the electronic components found on most cars, the RMC module requires a fully charged battery to work properly. If the system voltage falls below 12 V, an accurate diagnosis of the RMC module is impossible because the module will be temporarily disabled by low voltage.

1. Disconnect the molded 8-pin plug from the RMC module. See Figure 7.5.
2. Looking at the plug head-on, it will be configured as shown in the diagram: There will be 8 female pin terminals. When probed, they should yield the results described in the following sections. See Figure 7.5.
3. Check the PTO and seat safety circuits with the 8-pin pigtail connector unplugged, then reconnect it and continue with the RMC plug test.

Yellow wire with black trace

- **Behavior:** When the female pin terminal leading into the main harness is probed (yellow wire with black trace), it should show DC power with the key on and the PTO switch off.
- **Circuitry:** The yellow wire with a black trace is the ground side of the PTO relay coil. It splits with one lead going to the PTO switch and the other going to the RMC module.
- If there is continuity to ground when the PTO is OFF, the switch may be inoperative or there may be a short to ground in the wire leading to it. If there is not continuity to ground when the PTO switch is ON, the PTO switch may be inoperative, or there may be an open condition in the wire that leads to it.
- **Interpretation:** If behavior is correct, the N.C. side of the PTO switch /circuit is functioning properly

Yellow wire

- **Behavior:** When the female pin terminal leading into the main harness is probed (yellow wire), there should be continuity to ground *only* when the seat is empty.
- **Circuitry:** The yellow wire with white trace leads to the seat safety switch, where it finds a path to ground when the seat is empty.
- **Interpretation:** If behavior is correct, the seat safety circuit is good. If there is continuity to ground when the seat is occupied, the switch may be inoperative, or there may be a short to ground in the wire leading to it. If there is not continuity to ground when the seat is empty, the switch may be inoperative or there may be an open condition in the wire leading to it.

Z-Force-S

Red wire with black trace

- **Behavior:** There is a red wire with black trace between yellow wire with a black trace and the green wire. This wire provides the module with input from the reverse switch. When the mower is in reverse, this terminal should have continuity to ground.
- **Circuitry:** This wire runs directly to the reverse safety switch on the drive pedal shaft. This is a simple metal tang switch that grounds-out against a bolt.
- **Interpretation:** Continuity to ground when the mower is not in reverse would indicate a short to ground. This could take the form of a chafed wire contacting ground, a bent reverse safety switch that is always in contact with another metal part, or a broken plastic insulator that separates the switch from the drive pedal shaft.

Lack of continuity to ground would indicate a broken or disconnected wire leading to the reverse safety switch, or a switch that is not closing because of physical damage or corrosion.

Green wire

- **Behavior:** At the opposite end of the top row from the yellow wire with black trace is a green wire. The green wire should always have continuity to ground.
- **Circuitry:** The green wire leads to ground.
- **Interpretation:** If this ground path is not good, there will probably be other ground-related issues with the mower: slow starter motor, slow battery charge, dim lights. All ground connections should be mechanically secure and corrosion free.

Red wire

- **Behavior:** The red wire on the OCR plug carries battery voltage. It should show D.C. battery voltage when the key switch is in any of the run positions.
- **Circuitry:** This wire draws power directly from the A1 terminal on the key switch.
- **Interpretation:** If there is no battery voltage at this terminal, the mower is probably not functioning at all. Look for a blown fuse, disconnected battery or some other major fault.

Purple wire

- **Behavior:** There should be continuity to ground at this terminal when the key switch is in the REVERSE CAUTION MODE position.
 - **Circuitry:** When the key switch is in the REVERSE CAUTION MODE position, a ground path is established by connecting terminal A2 to terminal L within the key switch. The purple wire from the RMC module connects to A2, and a green ground wire connects to L.
 - **Interpretation:** If the purple wire fails to reach a ground path when the key switch is in the REVERSE CAUTION MODE position, the RMC module will not arm or operate. Check the key switch for continuity between A2 and L in the REVERSE CAUTION MODE position, confirm that the green wire connecting to the L terminal does have good continuity to ground, and check for any loss of continuity in the purple wire that extends from the key switch to the RMC module, including the molded connector between the two components.
4. If the RMC plug test indicates fault with any of the safety switches, the next step is to test the suspect switch. The operation of those switches is described in the following sections.

PTO Switch

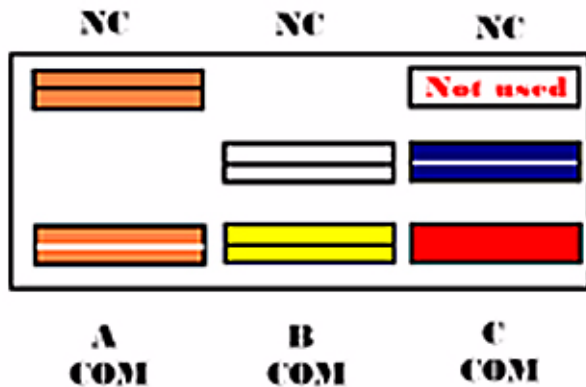

Figure 7.6

Understanding the PTO switch

1. A-COM is in the starter inhibit circuit. It is a normally closed (NC) set of contacts. Power coming from the brake switch (key switch in START, brakes ON) flows through the orange wire with black trace to the PTO switch. When the PTO is OFF, and the contacts are closed, the power continues through the orange wire with white trace to the trigger terminal on the starter solenoid.
2. B-COM is in the PTO relay latch circuit. It is a normally opened (NO) set of contacts. The yellow wire with a black trace is connected to the RMC module and the coil of the PTO relay. When the PTO switch is in the "ON" position, the yellow wire with a black trace is connected to the white wire with a black trace. If the PTO relay is energized, a ground signal will pass through the white wire with a black trace to the yellow wire with a black trace keeping the relay energized.
3. In C-Com, power is supplied to the PTO switch from the A1 terminal of the ignition switch through a red wire. When the PTO switch is turned on, this completes the circuit to allow power to go to the PTO clutch. It is a normally opened (NO) set of contacts.

NOTE: The top terminals are showing normally closed at rest and the middle terminals are normally open at rest

NOTE: There are three contacts on the right side in the C-COM. For this application the normally opened (NO) contact is used.

Parking Brake Switch

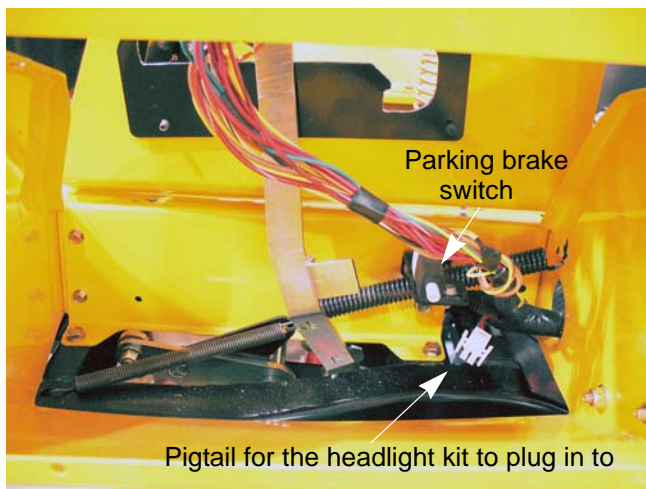

Figure 7.7

NOTE: The left control panel was removed to view the switch.

The parking brake switch is mounted inside left side control pod, underneath the parking brake control lever plate. See Figure 7.7.

- The plunger on the switch is depressed when the parking brake is set. The switch contains two sets of contacts.
 - A normally open (NO) set of contacts is in the starter inhibit circuit. When the parking brake is set, the contacts are closed, power coming from the key switch (key switch in START) through the orange wire is passed on to the PTO switch through the orange wire with black trace.
 - A normally closed (NC) set of contacts is in the safety shut-down circuit. The yellow wire with a white trace carries a ground signal from the seat switch (seat is empty). Setting the parking brake closes the contacts, passing the ground signal through the yellow wire to the magneto primary windings.
- The yellow wire with a white trace leads to one element of the seat switch. If the seat is vacant *and* the pedal is up, the engine will turn off.

Z-Force-S

Reverse Safety Switch

The Reverse Safety Switch is mounted on the right side of the steering gear box. It is the same part number as the parking brake switch. It has two sets of contacts, but only the normally open (N.O.) set is used. See Figure 7.8.

- When the plunger is depressed, the contacts are closed providing a ground path to the RMC module.

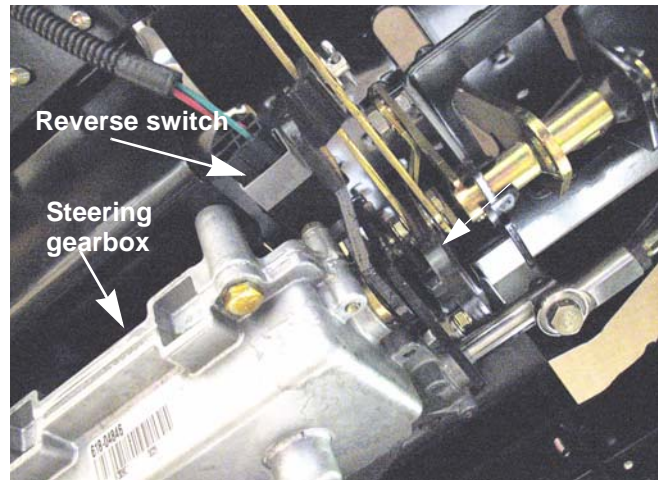

Figure 7.8

Seat Safety Switch

The Seat Safety Switch is mounted inside the seat. It contains two sets of N.O. contacts. See Figure 7.9.

- The yellow wire goes to the RMC module. When the seat is vacant, the contacts close, providing a ground path to the RMC module. If the seat is empty, the circuit is completed, turning off the RMC module.
- The yellow wire with white trace goes to the brake switch. When the seat is vacant, the contacts close, providing a ground path in series with the brake switch. If the brake is not applied, and the seat is empty, the circuit is completed, shorting out the primary windings of the magneto, turning off the engine.
- The two green wires are ground wires.
- The most common problems are likely to be caused by bad grounds in the green wires.

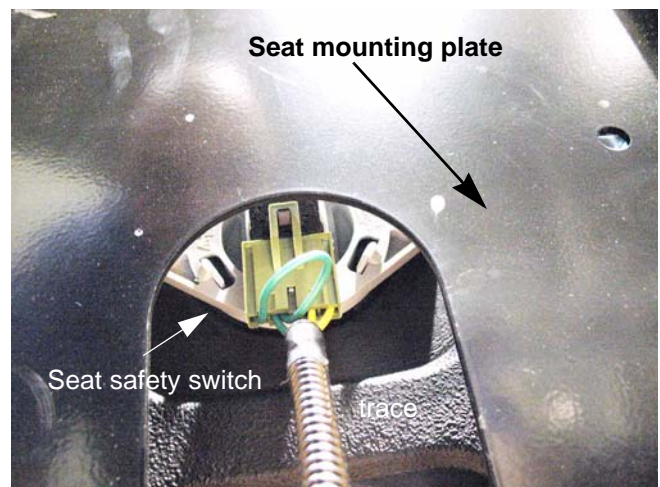

Figure 7.9

NOTE: The seat switch connector is a shorted N.C. connector. That means when the connector is unplugged, a tiny jumper inside the connector shorts out the contacts. When the connector is shorted, the circuit thinks that the seat is empty.

Starter solenoid

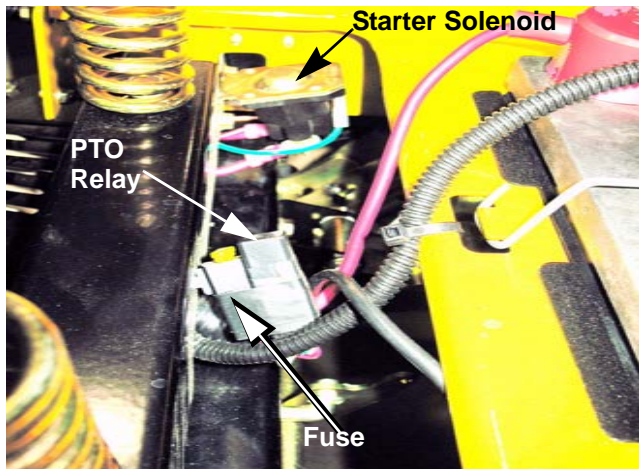

Figure 7.10

The starter solenoid is mounted to the rear frame cross member, under the seat. See Figure 7.10.

- When the proper safety conditions are met (brake applied, PTO OFF), the orange wire with white trace energizes the windings that magnetize an iron core, pulling the contacts closed between the two heavy posts, connecting battery power to the starter motor.

PTO Relay

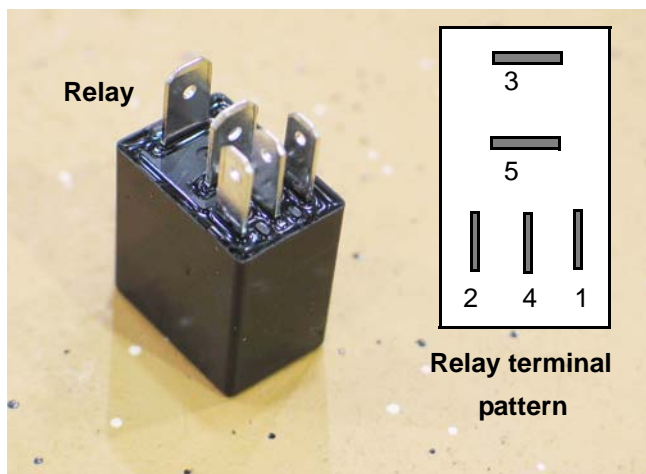

Figure 7.11

The PTO relay is mounted on the rear frame cross member, under the seat. See Figure 7.10.

The PTO relay disengages the PTO clutch when it is energized and latches on until the PTO switch is turned-off. The list below details the function of the PTO relay.

3	Green wire	COM (Common) terminal. Ground for PTO clutch (not energized) or relay latch (energized). Hard-wired to ground
5	White/black trace	Normally Open (N.O.) terminal Connects to COM terminal when the relay is energized. Power from PTO switch B-N.O. when PTO is ON.
2	Red wire	Power for windings Hot when the key switch is in any position other than OFF
4	White wire	Normally Closed (N.C.) terminal Connects PTO clutch to its ground path (through 30) when the relay is not energized.
1	Yellow/black trace	Ground path for windings Provides ground path, energizing the relay: when seat is empty and the PTO is turned ON or when the mower is put in Reverse and the PTO is turned ON, unless the RMC is armed and activated.

Z-Force-S

Lighting circuit

The Z-Force-S Headlight available as an optional kit. The headlight kit comes with a harness and a rocker switch to turn the headlights on and off. The main harness has a pigtail inside the left pod that the headlight harness plugs into.

- There is power to the headlight switch when the key switch is in any of the run positions.
- The red wire is connected to the A1 terminal of the key switch.
- The green wire is a ground

Start Circuit

Turning the key to the START position:

- spins the starter motor
- enables the ignition
- energizes the afterfire solenoid

Looking at the circuit that sends power to the starter motor: See Figure 7.12.

1. When the key switch is in the START position, battery power is passed from the B terminal to the S terminal.
2. Power goes from the key switch S terminal to the brake switch N.O. contacts. (orange wire)
 - 2a. If the park brake is off, the switch plunger will be up and the N.O. contacts will be open. The system monitor will measure open circuit voltage, illuminating the brake symbol.
 - 2b. If the park brake is set, the switch plunger will be depressed, and the N.O. contacts will be closed. Power will be passed along to the PTO switch.
3. When the key is in START, and the park brake is set, power will continue to the A-N.C. terminal of the PTO switch (orange/black trace).
 - 3a. If the PTO switch is on, the N.C. terminal on the A set of contacts will not connect to anything. The system monitor will measure open circuit voltage, illuminating the PTO symbol.
 - 3b. If the PTO switch is off, the N.C. terminal on the A set of contacts will be connected to the COM terminal on the A set of contacts. Power will be passed along to the trigger terminal on the starter solenoid.
4. When the following conditions are met:
 - Key to START
 - park brake set
 - PTO off

The stater solenoid trigger terminal will receive power (orange wire).

5. When the starter solenoid is triggered, it internally connects the heavy red cable from the battery with the heavy red cable that leads to the starter motor. The starter spins.

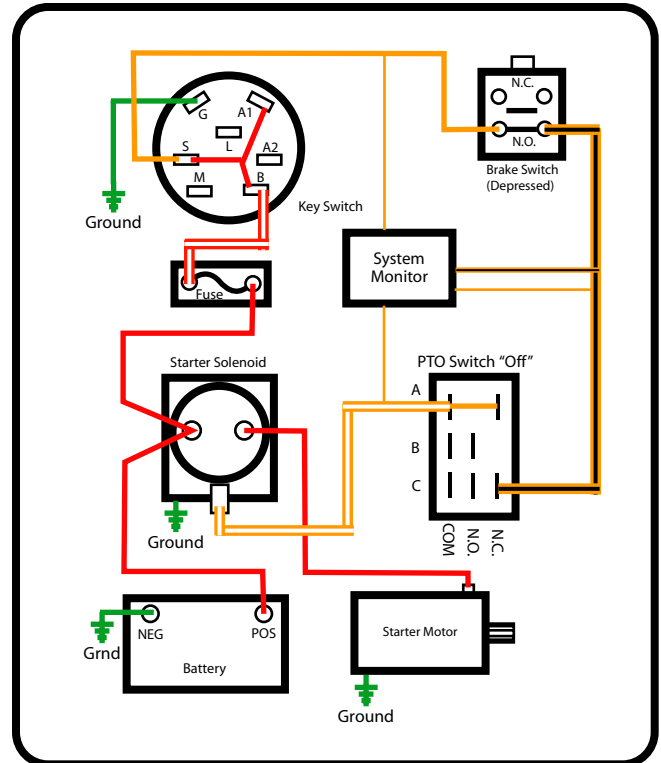

Figure 7.12

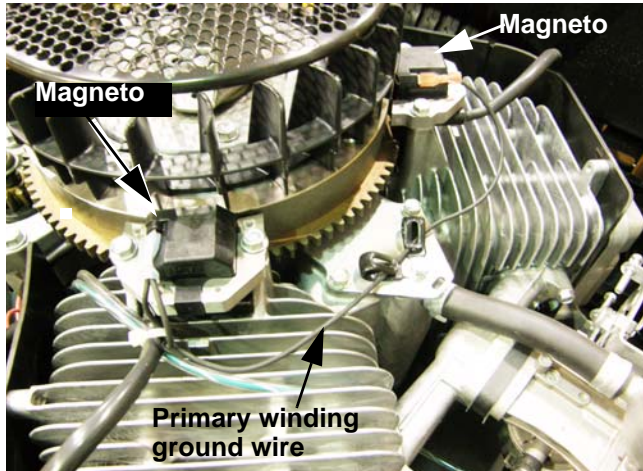

Figure 7.13

Once the starter motor spins, we still need spark and fuel to make the engine run. Looking at the circuits that do that:

1. The ignition sparks are generated by a **magneto**. The magneto will work as long as the primary windings are not grounded. With the key switch in any position other than off, there is no connection between the M (Magneto) terminal and the G (Ground) terminal. See Figure 7.13.
2. There is an **afterfire solenoid** on the carburetor. When it is energized, fuel flows normally through the carburetor. When it is not energized, it closes off the fuel flow through the main jet of the carburetor. The purpose of the solenoid is to prevent unburned fuel from being pumped through the engine after the ignition is turned off. This unburned fuel accumulates in the muffler and may ignite with an alarming noise. See Figure 7.14.

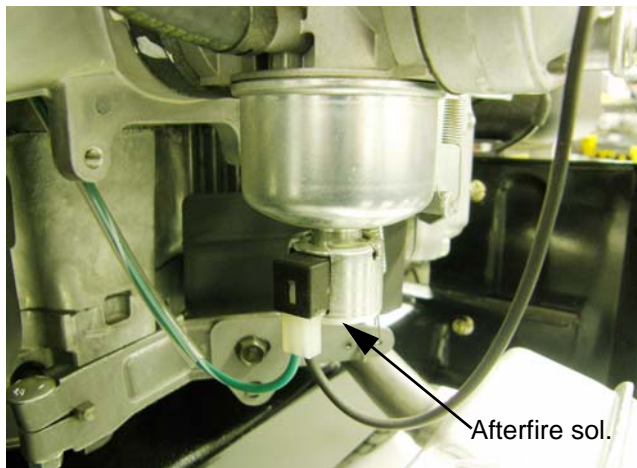

Figure 7.14

Z-Force-S

3. The A1 terminal on the key switch sends power to:
- the afterfire solenoid
 - the windings of the PTO relay
 - the PTO switch C-COM terminal
 - the RMC module "A1 pwr" terminal
 - the headlight switch, where used
 - the system monitor

See Figure 7.15.

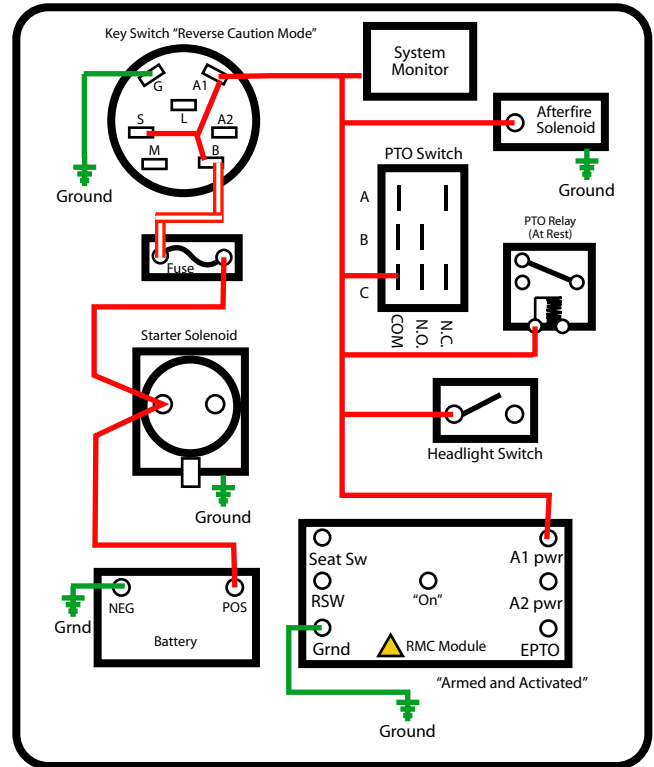

Figure 7.15

Run Circuit

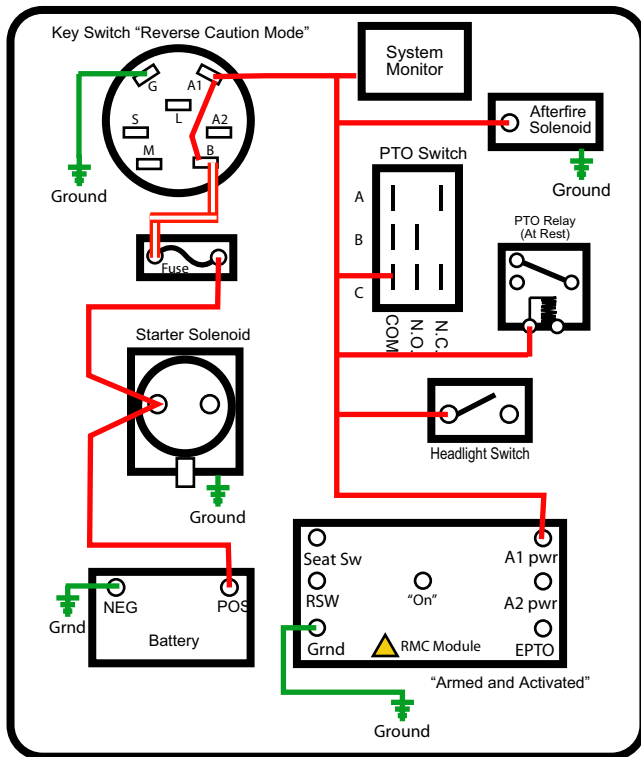

Figure 7.16

With the key switch in the RUN position, the A1 terminal sends power to:

- the afterfire solenoid
- the windings of the PTO relay
- the PTO switch C-COM terminal
- the RMC module "A1 pwr" terminal
- the headlight switch, where used
- the system monitor

See Figure 7.16.

This is identical to what happens with the key in the START position, except that the circuit that actually spins the starter motor is not energized.

Z-Force-S

Run Circuit / Reverse Caution mode.

1. With the key in Reverse Caution mode, A1 gets power from the B terminal, just like the normal run position.
2. In addition, A2 is internally connected to the L terminal. L is normally used for the lighting circuit.
 - 2a. In this case, a separate lighting circuit draws power from A1
 - 2b. L is connected to the ground wire on the G terminal by a jumper.
3. The RMC module arms when it gets a ground signal from A2 through the "A2 pwr" terminal on the RMC module. See Figure 7.17.

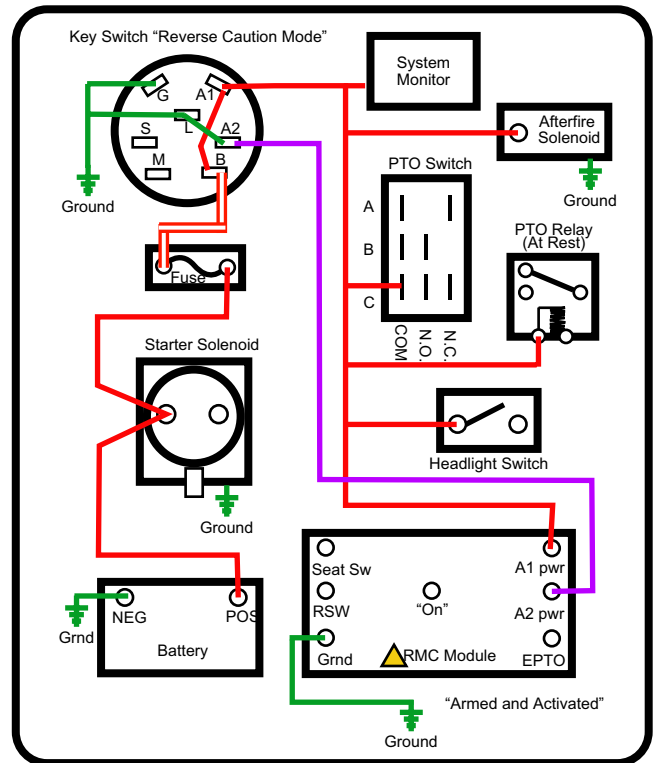

Figure 7.17

Engine shut-down circuits

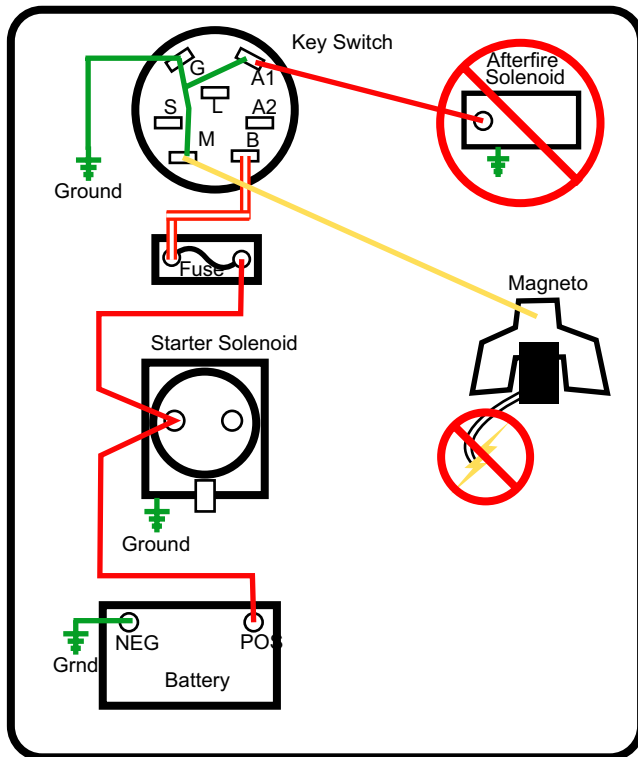

Figure 7.18

Engine shutdown circuits stop the engine by disabling the ignition and removes power from the afterfire solenoid.

Key switch shut-down: See Figure 7.18.

The key switch turned to OFF connects the M (Magneto) terminal and A1 to G (Ground).

- Grounding the magneto primary windings prevents the magneto from developing the magnetic field that it collapses to generate a spark. This disables the ignition.
- The A1 terminal is de-energized.

NOTE: On older electrical system, prior to 2008, the afterfire solenoid was powered by the alternator. In order to turn off the afterfire solenoid, the A1 terminal was shorted to ground inside the key switch. This drains the current from the alternator, de-energizing the solenoid. That function was left in place so that the same key switch can be used, but it is not needed. The Z-Force S powers the solenoid through the A1 terminal of the key switch and not the alternator.

Seat switch and brake switch: See Figure 7.19.

The seat switch and brake switch work in series to ground the magneto primary windings if the brake is released while the seat is vacant.

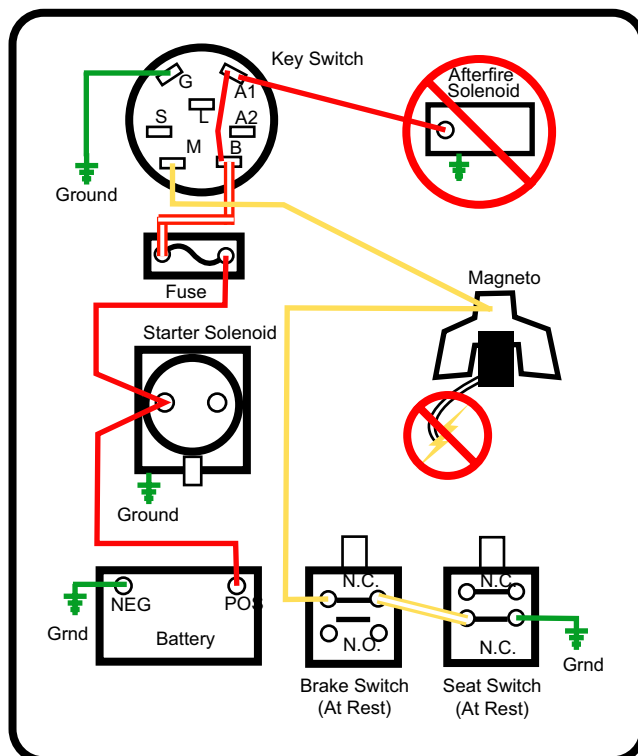

Figure 7.19

1. The magneto (yellow wire) is connected to the N.C. terminal of the **brake switch**.
 - 1a. When the park brake is applied, the plunger of the park brake switch is depressed, opening the N.C. (Normally Closed) contacts within the switch.
 - 1b. When the park brake is released, the plunger on the switch is extended, closing the N.C. contacts within the switch. This completes part of the ground path.
 - 1c. The seat switch is the next part of the ground path. The yellow wire/white trace connects the park brake switch to the seat switch.
2. The **seat switch** is connected to the N.C. terminal of the brake switch (yellow wire/white trace).
 - 2a. When the seat is occupied, the N.C. contacts within the seat switch are open.
 - 2b. When the seat is vacant, the N.C. contacts within the seat switch are closed. This completes the final leg of the ground path when the park brake is not set, disabling the ignition.

Z-Force-S

Charging circuit

How it works

1. When the engine is running, magnets attached to the underside of the flywheel induce A.C. (Alternating Current) in the stator that is mounted beneath the flywheel. See Figure 7.20.
2. The A.C. travels from the stator to and from the regulator/rectifier through the two white wires.

NOTE: The magnets inside the flywheel act as a rotor for the charging system.

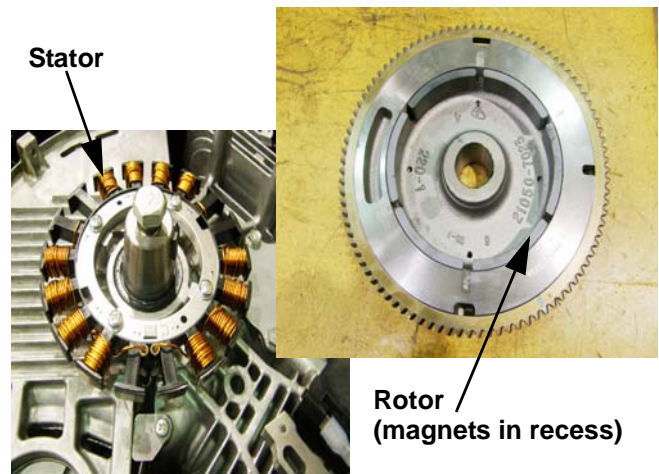

Figure 7.20

3. The regulator/rectifier takes alternating current and converts (rectifies) it to D.C. (Direct Current). The regulator rectifier also regulates the voltage to a nominal 12 volts. See Figure 7.21.
 - Actual output is closer to 14 volts, but should be no more than 15 volts.
 - To work properly, the regulator/rectifier must have a good ground connection to the engine block and ultimately, back to the battery negative post.
4. Regulated D.C. power leaves the regulator/rectifier.
 - 4a. A red wire comes out of the regulator/rectifier.
 - 4b. The red wire changes to a red/white trace wire at the harness connector.

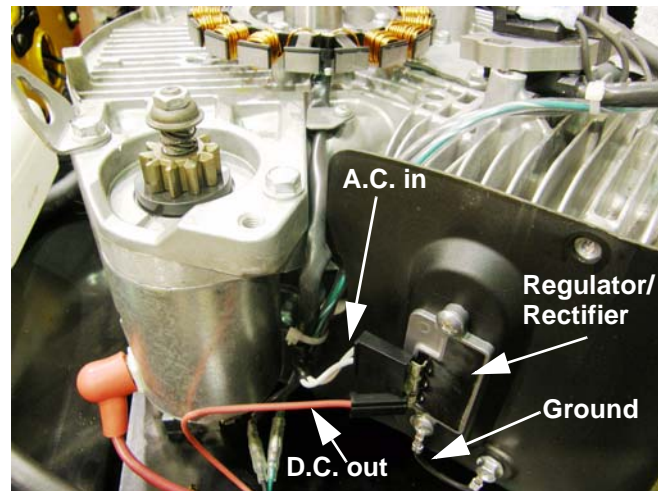

Figure 7.21

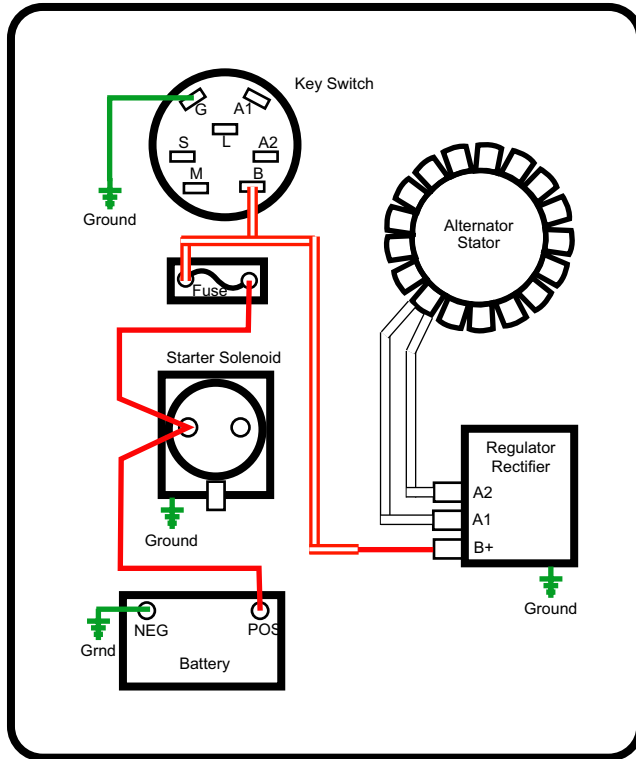

Figure 7.22

5. From the harness connector: See Figure 7.22.
 - 5a. The red/white trace wire leads to the 20A fuse.
 - 5b. From the fuse, the wire connects to the starter solenoid, sharing the “hot” post with the battery cable.
 - 5c. The shared post on the starter solenoid provides the final connection for the alternator output to reach the battery.

Testing Sequence:

1. Charge and check the battery or confirm that a known-good battery is installed in the mower.
2. Make a visual inspection of the mower. Look for:
 - Loose connections - power and ground
 - Corroded connections - power and ground
 - Ground wires all present
 - Blown fuse
 - Obvious damage to the wiring harness- burns, chafed wires, kinks.
3. Quick check, to see if there is a problem. See Figure 7.23.

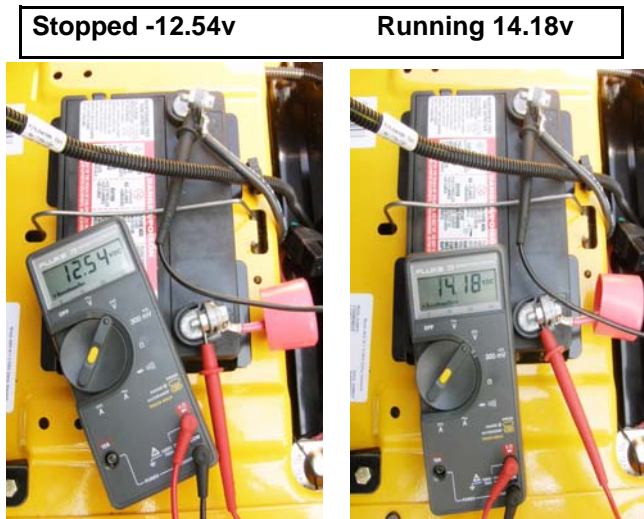

Figure 7.23

CAUTION This step involves running the engine. Before starting the engine, make sure that no unsafe conditions will arise from doing so. Potential hazards include: motion hazards from contact with spinning parts or moving equipment, heat-source hazards, and asphyxiation hazard.

- 3a. Check base-line battery voltage.
- 3b. Start the engine and advance the throttle to 3,000 RPM.
- 3c. Check operating voltage.
- 3d. If operating voltage does not rise with engine RPM, proceed with the system check.

Z-Force-S

4. System check, to identify the problem

The system check consists of:

- Stator Check
- Regulator Rectifier Check
- Down stream Check

5. Stator check: See Figure 7.24.

5a. Key OFF, unplug the stator from the regulate/rectifier.

5b. Check resistance through the stator using a digital multimeter set to read Ohms.

- It should be between 0.1Ω and 0.14Ω .
- A high reading indicates a fault in the windings.
- A low reading indicates a short in the windings.
- There should be a reading of O.L. (Open Line) between either lead and the engine block.
- It is good practice to check the stator cold, and again when the engine is at operating temperature.



Figure 7.24

5c. Check the raw output of the stator. See Figure 7.25.

- Connect a meter set to read Volts A.C. to the output leads of the stator.
- Start the engine and advance the throttle to 3,000 RPM.
- The stator should produce at least 26 Volts A.C. In some cases, output will be as high as 34 Volts A.C.



Figure 7.25

5d. Interpretation:

- If the stator fails either or both tests, it is likely to be bad.
- If the stator fails the out put test, but passes the resistance test, there is a possibility that the magnets on the rotor (flywheel) have lost their fields. This is theoretically possible, but extremely rare in practice.
- It is necessary to remove the flywheel to test the magnets. If the magnets inside the flywheel will draw a steel screwdriver to them, they are good. If not, the flywheel must be replaced.

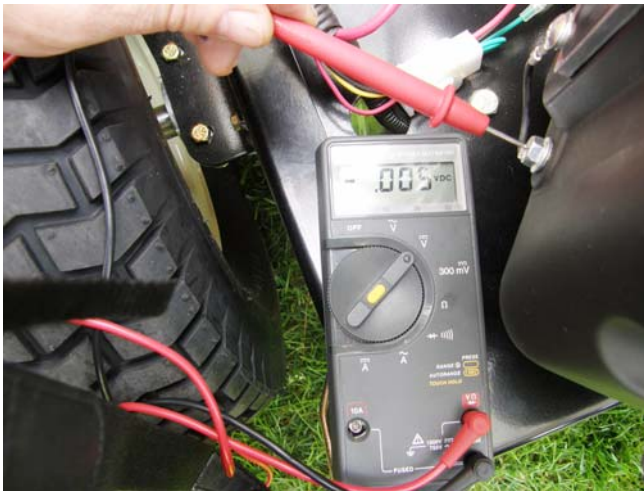

Figure 7.26

6. Regulator/rectifier check: See Figure 7.26.

6a. Check the ground.

- With the engine running and the stator leads re-connected to the regulator/rectifier, perform a ground-side voltage-drop test from the regulator/rectifier to the engine block.
- If the voltage reading is greater than 0.1 Volts D.C., replace or properly fasten the ground wire that connects the regulator/rectifier to the engine block. Retest to confirm good connection.

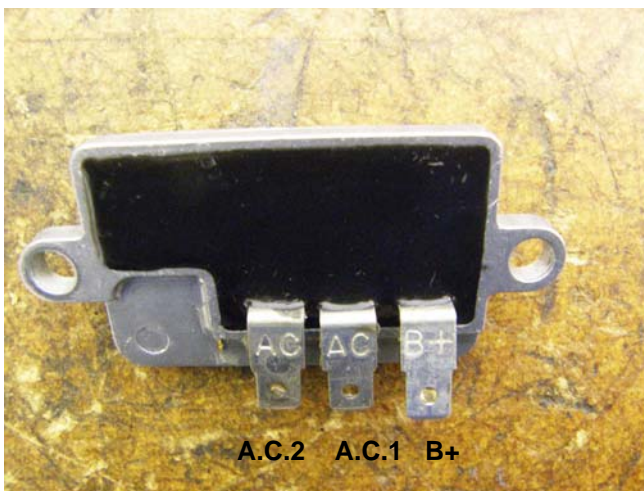

Figure 7.27

6b. Bench Test: See Figure 7.27.

- Set a digital multi-meter to read on the X100 Ω scale.
- With the key OFF and the fuse removed, unplug all the wires from the regulator/rectifier.
- Remove the regulator/rectifier from the engine (not strictly necessary, but provides easy access).
- Make the resistance tests described in the accompanying table.
- B+ is the D.C. terminal
- A.C.1 is the A.C. terminal nearest B+
- A.C.2 is the A.C. terminal furthest from B+

Z-Force-S

7. If the regulator/rectifier fails any one of these tests, replace it with a new one.

Test #	Pos. Probe	COM. Probe	Results
1	Housing	B+	O.L. (infinite resistance)
2	Housing	A.C. 1	O.L. (infinite resistance)
3	Housing	A.C.2	> 1.0 Ω (5 second delay)
4	B+	A.C.1	0 Ω (Perfect continuity)
5	B+	A.C.2	> 1.0 Ω
6	B+	Housing	> 1.0 Ω
7	A.C.1	B+	0 Ω (Perfect continuity)
8	A.C.1	A.C.2	> 1.0 Ω
9	A.C.1	Housing	> 1.0 Ω
10	A.C.2	B+	O.L. (infinite resistance)
11	A.C.2	A.C.1	O.L. (infinite resistance)
12	A.C.2	Housing	> 1.0 Ω

8. Check the D.C. amperage output of the regulator/rectifier using an Ammeter of sufficient capacity or a D.C. Shunt tool and a volt meter set to read on the millivolt scale, as described in the TOOLS section of this chapter.
9. If the regulator/rectifier passes all of these tests, but the battery is not charging, check the circuit between the regulator/rectifier D.C. output (B+) terminal and the battery positive post for voltage for a voltage drop. See Figure 7.28.
- The harness connector, the 20A fuse, and the hot post on the starter solenoid all lie between the regulator/rectifier and the battery.



Figure 7.28

PTO Circuit

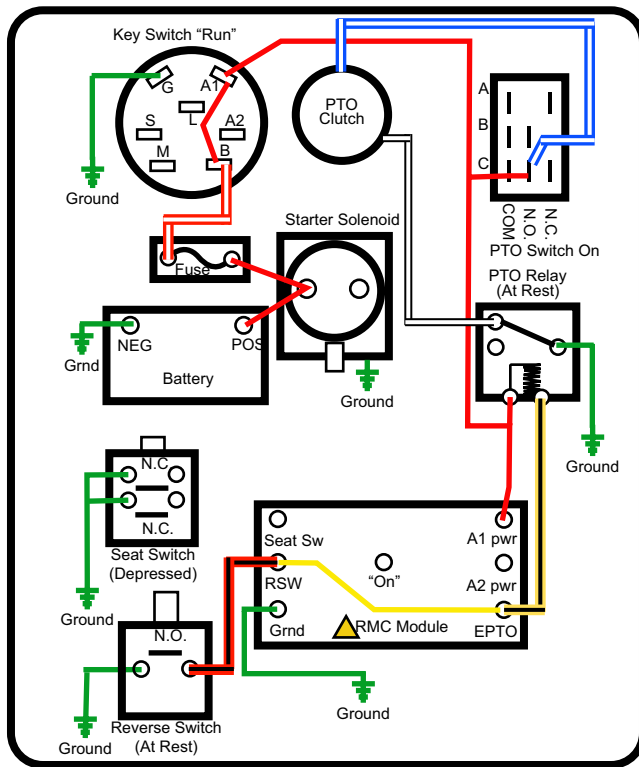

Figure 7.29

Basic Operation: See Figure 7.29.

1. With the key switch in any position other than OFF, the A1 terminal supplies power to the windings of the PTO relay and to the C-COM terminal of the PTO switch.
2. The PTO clutch gets power from the A1 terminal of the key switch through the C-N.O. terminal of the PTO switch when it is turned ON.
3. The PTO clutch gets ground through the PTO relay COM terminal via the PTO relay N.C. terminal when the relay is not energized.

Safety Circuits:

There are some conditions when it is best to automatically turn off the mower deck to ensure safety.

- When the mower is put in Reverse, we want to turn off the blades unless the RevTec (RMC) module has been armed and engaged.
- When the operator leaves the seat for any reason, we want to turn off the blades.

NOTE: When the operator leaves the seat without setting the park brake, the engine turns off stopping the blades as well.

1. The PTO clutch loses its ground when the PTO relay is energized. See Figure 7.29.
 - 1a. The Yellow/black trace wire connected to the windings of the PTO relay leads to the “E-PTO” terminal on the RMC module.
 - 1b. The reverse switch has N.O. (Normally Open) contacts.
 - A green wire from one terminal is a ground path.
 - A red/black trace wire on the second terminal leads to the “Rev.Sw” terminal on the RMC module.
 - 1c. When the mower is put in reverse, the plunger on the switch is depressed, closing the contacts.
 - 1d. The closed contacts complete a ground path that passes through the RMC module from the Rev.Sw terminal to the E-PTO terminal when the RMC module is not armed and activated.

NOTE: When the RMC module is armed and activated, Rev.Sw terminal is disconnected from the E-PTO terminal inside the module.

- 1e. The ground path reaches the PTO relay windings, and the PTO relay is energized when the mower is put in reverse.

Z-Force-S

2. The seat switch contains two sets of contacts. The set with the yellow wire leads to ground when the contacts of the seat switch are closed. See Figure 7.30.
 - 2a. When the operator leaves the seat, the seat switch connects the yellow wire to a ground path.
 - 2b. That ground path passes through the RMC module to ground the PTO relay windings when the mower is put in reverse.

NOTE: The seat switch connector is a shorted N.C. connector. That means when the connector is unplugged, a tiny jumper inside the connector shorts out the contacts. When the connector is shorted, the circuit thinks that the seat is empty.

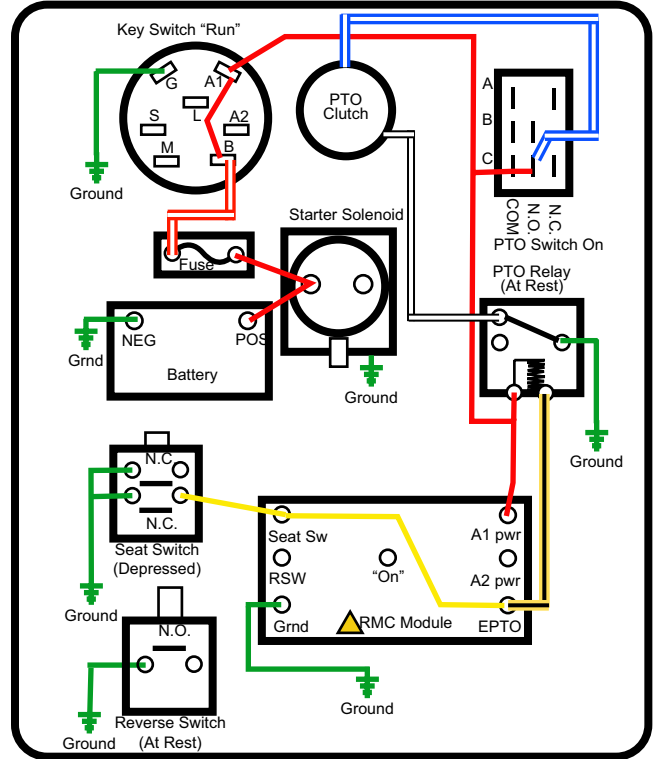

Figure 7.30

3. Once the PTO relay is energized by a ground path through one of the safety switches, it latches. See Figure 7.31.
 - 3a. The PTO clutch ground path that passes through the PTO relay is disconnected from the clutch.
 - 3b. The ground path formerly used by the clutch is shifted to provide a second ground path for the relay windings.
 - 3c. Once the relay windings have established the second ground path, the relay is latched on, even if the ground path that initially energized the relay is broken.
 - 3d. The second ground path loops through the B contacts inside the PTO switch. As long as the PTO switch is in the ON position, the second ground path will continue.
 - 3e. For this reason, when the PTO is shut off by the seat switch or the reverse switch, it is necessary to get back in the seat or take the mower out or reverse and turn the PTO switch off and back on again to re-engage the PTO.

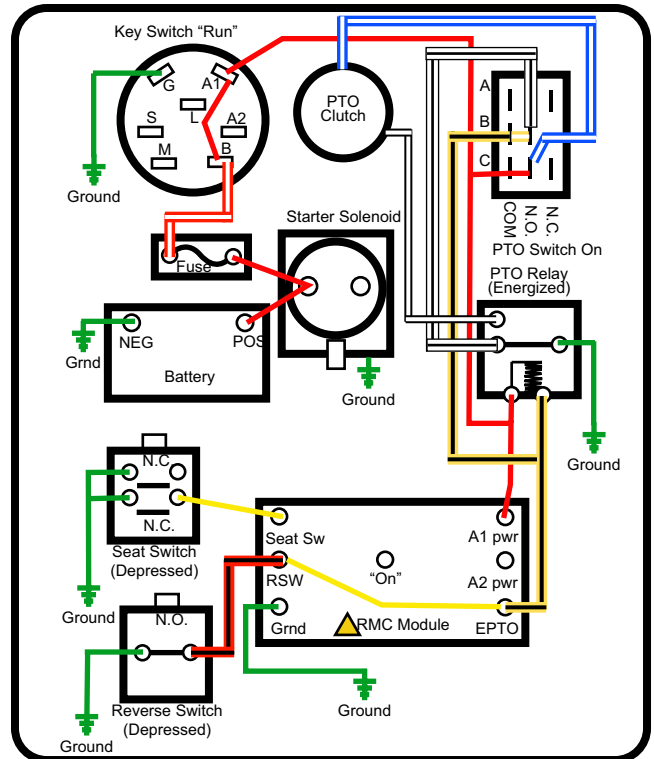

Figure 7.31

Reverse Mower Control (RMC) circuit operation

Historically, Cub Cadet home owner mowers have not been able to mow in reverse. This has not been required by any laws or safety regulations, it was just safer for our customers and those around them. In 2005 we introduced the Reverse Mower Control that allows the operator to over-ride the circuit that turns the mower deck off in reverse.



Figure 7.32

We want to make sure that the operator of a mower with Reverse Mower Control is always cognizant of the risks that they take upon themselves by mowing in reverse. To accomplish this, we make the operator take two distinct actions: See Figure 7.32.

1. The operator must arm the RMC module by turning the key switch to the Reverse Caution Mode position.
2. Once armed, the RMC module must be engaged by pressing the orange triangular button on the front of the module. When it is armed and engaged, a red LED on the face of the module lights-up.

If the **operator gets out of the seat**, the mower has no way of knowing if the same person had gotten back into the seat. For that reason, the module shuts-down and dis-arms itself whenever the seat is vacated. The person who gets back in the seat must then re-arm the module by turning the key out of and back into the Reverse Caution Mode position.

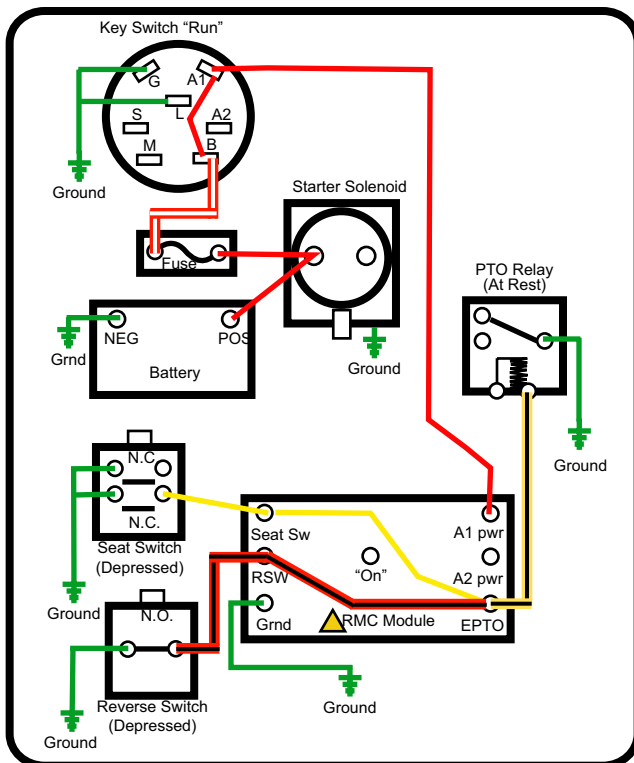

Figure 7.33

The easiest way to understand the RMC circuit is to think of the RMC module as a switch that obeys commands.

In normal operation, the reverse safety switch and one set of contacts in the seat switch simply pass through the module to connect with the yellow/black trace wire that triggers the PTO relay by providing a ground for the windings. See Figure 7.33.

Z-Force-S

When the RMC module is armed and activated, it effectively disconnects the reverse switch from the circuit. See Figure 7.34.

The RMC module is disarmed and de-activated when the seat is vacated; it gets a ground signal through the second set of contacts in the seat switch.

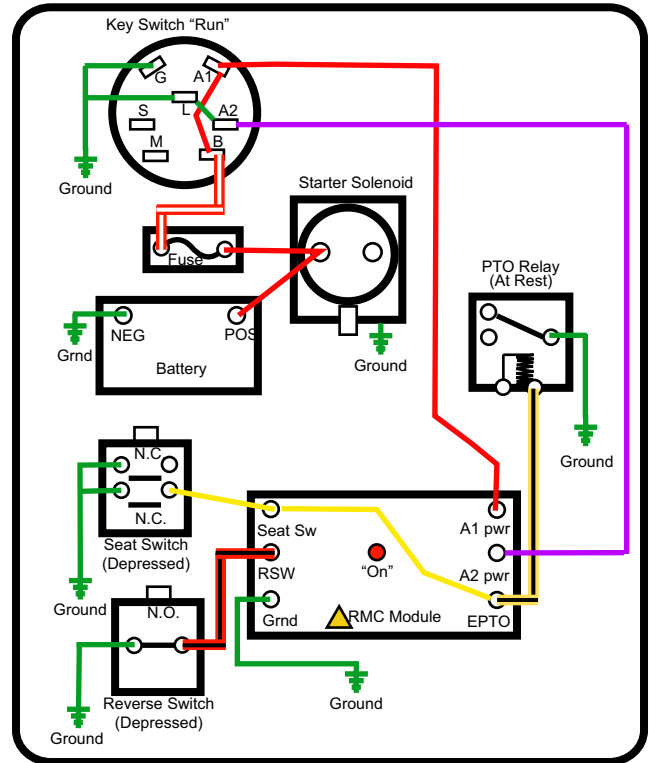

Figure 7.34

Electrical diagnosis

NOTE: Electrical diagnostic procedures and tools are the same for all Cub Cadet and MTD mowers. This section is written in a way to provide basic trouble shooting skills that can be used on any mower.

With a basic understanding of the behavior of electricity and the tools used to measure that behavior, a technician can be about 80% effective at finding electrical problems.

80% effective is not bad, but the remaining 20% of the diagnoses are the really difficult ones that can devour the same amount of time as the easy 80%. Experience plays a big part in successfully diagnosing the really difficult electrical problems. Experience leads to greater understanding.

Two German Physicists, working independently during the late 18th and early 19th centuries, summarized what they had figured out about electricity into some basic laws that can help a technician understand how a system works or why it does not work. Their names were Gustav Kirchhoff and Georg Ohm, and their laws are named for them.

There are basically three things that a technician is likely to test in trying to identify an electrical problem: Volts, Resistance, and Current. To help technicians understand the behavior of electricity, this section begins with an explanation of:

- Basic electrical values.
- Ohm's law.
- Kirchhoff's current law.
- Kirchhoff's voltage law.
- How the system is wired together.

NOTE: A graphic explanation of Kirchhoff's laws can be found at the following web site:

<http://online.cctt.org/physicslab/content/phyapb/lessonnotes/DCcircuits/lessonKirchoff.asp>

The section then continues by explaining handy tools and techniques for diagnosing electrical problems on outdoor power equipment.

Electronics

Outdoor power equipment has historically had relatively simple electromechanical controls. Customer expectations and regulatory demands has driven change in the industry, while electronic controls have become relatively inexpensive.

In many cases, electronic controls can simplify a system that would otherwise be very complex. Instead of creating a huge mass of switches and relays that are tied together by spaghetti-like wiring harness, sensors (switches) in an electronic system send signals to a processor. These input signals are processed by a control module that produces outputs.

Outputs can include power to run an electric PTO clutch, a trigger signal to a starter solenoid, or the grounding of a magneto to turn off an engine if an unsafe condition exists.

Most electronic devices are quite dependable, but they are vulnerable to things that simple electrical devices are not bothered by. Examples include:

- **EMI:** Electro-Magnetic Interference is created by electric "noise". This noise is created by ignition systems in general with non-resistor spark plugs being especially "noisy". Alternators, and even power passing through wires can also generate EMI. Countermeasures against EMI include metal shielding (take a look at the ignition system on a fiberglass-bodied Corvette), and filtering devices built into vulnerable components. Something as simple as putting non-resistor spark plugs in a machine with electronic controls can disable the controls.
- **Voltage Spikes:** A dramatic increase in voltage will damage many electronic devices. Such spikes may be caused when jumper cables are disconnected or a voltage regulator fails. Some early automotive systems could even be damaged by personal discharge of static electricity. Most are better protected now.

Z-Force-S

- **Low Voltage:** Many electronic devices simply stop working if system voltage falls below a given threshold. If a 12 volt system is run at 11 volts with a failing alternator, electronic controls may stop working.
- **Bad Grounds:** Bad grounds can reduce the effective system voltage, create resistance and heat, and send false signals. This is the single most common breeding ground of electronic gremlins.
- **Heat and Vibration:** Heat and vibration are hard on most mechanical devices. The same is true of electronics.
- **Moisture:** Moisture causes a nasty combination of corrosion and shorts. Corroded connections and wires create resistance that results in low voltage and ground issue. Many electronic components are “potted” or encased in a sealant that protects them from moisture. They are still vulnerable to bad inputs caused by corroded external connections and damaged switches.
- **Improper Tools:** Some test lights can over load electronic circuits.

Electrical environment: AC Vs. DC

Most modern outdoor power equipment that has an electrical system complex enough to require diagnosis will be equipped with an alternator that produces alternating current (AC). In most systems, this current is immediately rectified to direct current (DC), and regulated to a nominal 12 Volts. The presence of AC is very limited. The primary concern of this section is 12 Volt DC systems, though much of the theory and techniques apply equally well to other DC systems.

1. Voltage: Pressure

- Voltage is the “pressure” that electricity has. It is the amount of force pushing electrons through a circuit.
- The unit of measurement for this pressure is volts.
- The capital letter “V” is used to represent volts.
- Most (not all) outdoor power equipment operates on a nominal 12 volts. In practice, system voltage may run as high as 13.5V or 14V.

2. Current: Flow

- Current is the “flow” of electricity. It is the amount of electrons flowing in the circuit.
- The flow of current is measured in Amperes or Amps for short.
- The capital letter “I” (*Intensity* of current flow) is used to represent Amps.

3. Ohms: Resistance

- Resistance is the opposition to current flow. It is a restriction that slows down the flow of current.
- Resistance is measured in Ohm’s.
- The greek letter omega “ Ω ”, or the letter “R” for Resistance is used to represent Ohm’s.
- Resistance creates heat. A circuit with too much electrical load or too much resistance for the load placed on it will get hot.

Ohm's Law

Ohm's Law relates voltage, amperage, and resistance. It states that voltage is the product of resistance times current.

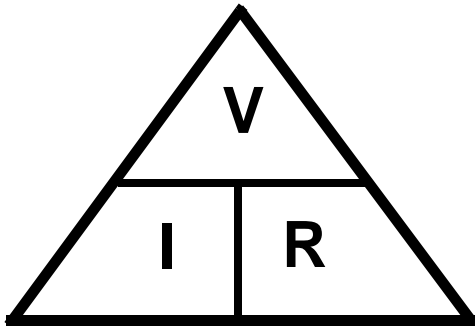

Figure 7.35

- It is written as $V = I \times R$.
- In simplest terms, it goes like this:
It takes 1 volt to push 1 amp through a resistance of 1 ohm ($1 = 1 \times 1$).
- This equation can be rearranged using algebra to solve for any one variable.
- Those who were traumatized by algebra can represent Ohm's law as a triangle. When using the triangle, cover the value to be found, and the two values left exposed signify how to obtain that value. See Figure 7.35.
- As an example if the "R" is covered, the "V" is over the "I" which means "V" divided by "I" will solve for the covered letter "R" ($V/I = R$).
- If the "V" is covered, "I" and "R" are exposed on the same line, meaning that the product of "I" times "R" will solve for the unknown "V" ($I \times R = V$).

Kirchhoff's current law

Kirchhoff's current law deals with nodes. Nodes are the junction of two or more wires or the junction of a wire to a component.

Kirchhoff's current law states that what ever current goes into a node must come out.

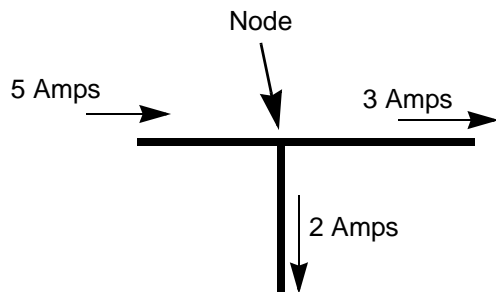

Figure 7.36

As an example: Three wires are connected with a wire nut. One wire has 5 amps going into the connection:

- The sum of the currents coming out of the other two wires must equal 5 amps. That could be 3 amps in one wire and 2 amps in the other or it could be 2.5 amps in each wire, but the total coming out must be the same as the current going in. See Figure 7.36.

Z-Force-S

Kirchhoff's voltage law

Kirchhoff's voltage law deals with voltage drops. A voltage drop is the amount of voltage used up or "dropped" by resistance in a circuit. Ohm's law states that $V = I \times R$, every component in a circuit has resistance, even the wires. To push current through resistance, it takes voltage. Kirchhoff's voltage law states that the sum of all the voltage drops equals the source voltage.

As an example, imagine a circuit that has a 12V battery that produces 4 amps of current powering a light bulb that creates 3Ω of resistance. The wires are assumed to have 0Ω resistance*. The light bulb uses 12 volts (4 amps x 3 ohms = 12 volts). The battery produces 12 volts that equals the 12 volts used by the light bulb. See Figure 7.37.

NOTE: * If the proper size wire is used and there is no corrosion in the wire, the resistance will be too small to worry about.

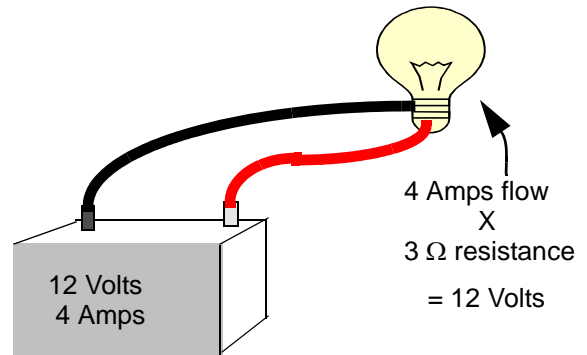

Figure 7.37

How the system is wired together

The Rules

All circuits have some basic rules that must be followed:

1. All circuits must have at least one voltage source. It could be a battery, an alternator or both.
2. All circuits must have a load. A circuit without a load is the same as shorting out the power source. Typical loads could be:
 - lights
 - a motor
 - a solenoid
3. All circuits must have a complete path back to the voltage source. This is also known as having continuity.

NOTE: On outdoor power equipment, the frame of the machine is frequently used as the return path to the battery. This is referred to as grounding the machine. Any point on the frame should be the same as the negative post of the battery (Electrically) unless there is a bad connection between the battery and the frame or between the frame and the component or cable that is assumed to be grounded to it.

4. Most circuits have additional components like switches and fuses.

Types of circuits

There are three ways a circuit can be wired:

- Series
- Parallel
- Series/parallel

Series

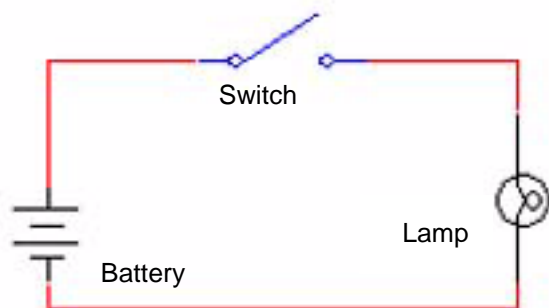

Figure 7.38

Series circuits are wired so that the current has only one path to follow. If one component in the system fails, the circuit will be broken and whole system will not work. See Figure 7.38.

Parallel

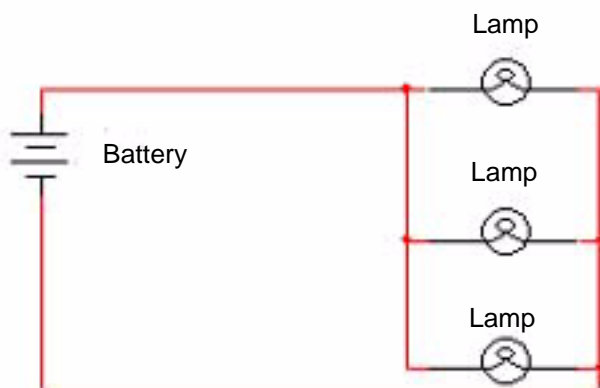

Figure 7.39

Parallel circuits are wired so that current has multiple paths to follow. If a component in one of the parallel paths fails, the rest of the circuit will keep working. See Figure 7.39.

Z-Force-S

Series/parallel

Series/parallel circuits have some sections wired in series and some in parallel. See Figure 7.40.

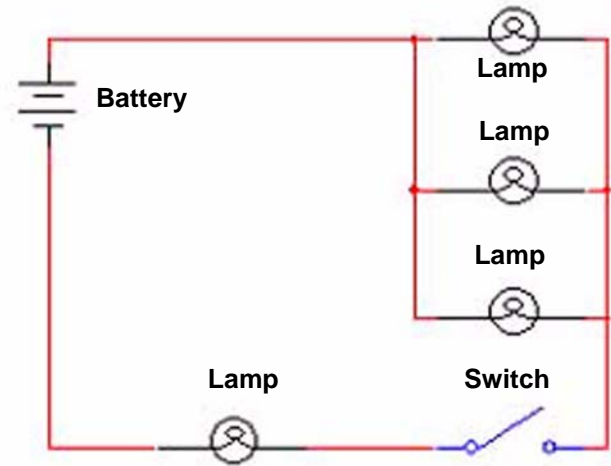

Figure 7.40

What can go wrong?

There are three types of failures that can occur in an electrical circuit:

1. Shorts
2. Opens
3. Increased resistance

Shorts

A short is when electricity takes a path that it was not designed to take by-passing a component in the circuit.

A common example of a short is a wire with insulation that chafed through, exposing the copper conductor. The bare copper will short the circuit when it touches a ground source.

Opens

An open is when current can not complete its path back to the power source. A common example of this is a burned-out lamp (light bulb) in a series circuit.

Increased resistance

Increased resistance is, as the name implies, an increase in resistance.

This can be caused by loose or corroded connections, or connections that are insulated by grease, paint, or coatings. Fasteners finished in oil/phosphate or black oxide are bad conductors. Use bright fasteners (zinc coated).

Resistance can be a problem on the ground side as well as the hot side of a system. Remember that electricity must complete a loop (circuit) back to the battery post. Any resistance in that loop will interfere with the flow.

Arguably the most common electrical failure, and the hardest to find, increased resistance can have more subtle symptoms than outright open circuits. Many times affected circuits will still partially function. It is not an open because there is some current that can get through, but the increase in resistance is enough to affect the circuit.

The Tools

Equipment needed to diagnose an electrical system:

- DMM (Digital Multi-Meter)
- Wiring schematic or diagram

Equipment that may be useful:

- Fused jumper wires.
- Test light
- Self-powered continuity light
- Ammeter
- Battery charger
- Battery tester
- Battery jumper cables
- Hand tools to gain access to components.
- Flashlight.

Z-Force-S

Digital Multi-meter

A DMM is the most useful tool to troubleshoot any electrical system. There is an amazing variety of DMMs on the market. Some are very basic, others are tailored to specific industries, and some high-end graphing meters function like oscilloscopes. Even the most basic ones are quite versatile. See Figure 7.41.

Uses

Voltage

Set meter to read “Volts DC (_ _ _)” if using an auto-ranging meter or to an appropriate scale (typically 20 Volts DC) if using a more basic model.

- Connect the **meter in parallel** to the circuit being measured, between the test point and a known-good ground. Turn on the circuit to be tested, and read the meter. For most tests the engine need not be running, but the key will need to be turned on.
- If the meter is connected with the **polarity** reversed, a “-” will appear in front of the voltage reading. It has no ill effects on the meter nor on accuracy.
- If the meter is set to Volts AC (~) it may not register any DC voltage, but no physical harm will be done to the meter nor the equipment being diagnosed. It may waste some time though.

Amperage

Most DMMs have a very limited capacity to test amperage (10 Amperes). When measuring current flow, the meter must be connected in series with the component to be measured. That means opening the circuit and having the circuit go through the meter.

NOTE: Some meters have an inductive “Amp clamp” accessory that can be used without breaking the circuit.

IMPORTANT: Testing amperage beyond the capacity of the meter can burn out an internal fuse in some meters. The fuses can be expensive.

Resistance

Set the meter for the “ Ω ” scale.

- Isolate the part of the circuit to be tested (disconnect it from the source of power).
- Most auto-ranging meters will provide readings on several scales. For outdoor power equipment, the straight Ohm scale is most appropriate. If a letter appears next to the W on the screen of the DMM, it indicates different scales of sensitivity.
 - “ μ ” is micro-Ohms, meaning is 1,000,000th (0.000001) of an Ohm
 - “**m**” is milli-Ohms, meaning is 1,000th (0.001) of an Ohm.
 - “**K**” is Kilo-Ohms, meaning 1,000 Ohms.
 - “**M**” is Meg-Ohms, meaning 1,000,000 Ohms
- A reading of “0” may be called “**Continuity**”. A reading of “OL” may be referred to as “**No Continuity**”.
- Mistaken Ohm readings most frequently come from bad technique. Poor connections between the probes and the point to be read can throw-off readings. False readings can be generated if the technician touches both probes with their fingers while taking the reading.
- The meter has it’s own power source to measure resistance. Connecting the meter to a component that has current going through it will damage the meter (usually beyond repair).



Figure 7.41

Wiring diagram or schematic

A wiring or a schematic diagram, and the ability to read it are very important in troubleshooting a circuit. The diagram shows how the circuit was designed and what paths the electricity is suppose to flow.

Fused jumper wires

Fused jumper wires are handy to help find bad grounds or to jump across switches for testing purposes.



Only use fused jumper wires. If there is a short in the circuit, using an un-fused jump could damage components in the circuit.

Test lights

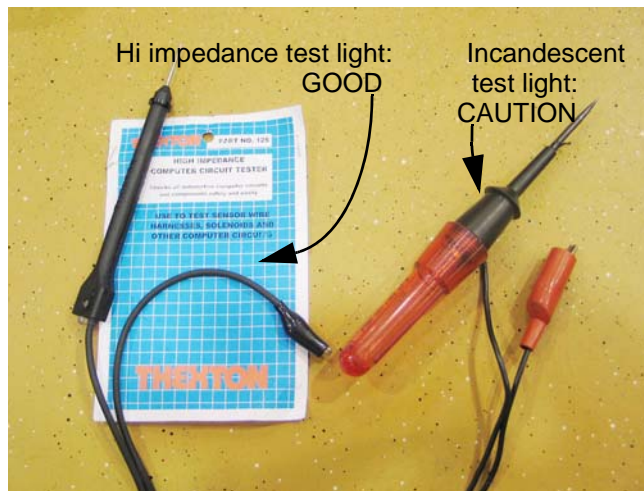

Figure 7.42

Test lights are used as a quick way to verify voltage at a point in a circuit. Like DMMs, they come in a wide variety from many manufacturers.

The most basic test lights simply use the current being checked to light an incandescent lamp. These should not be used on any equipment that has or may have solid-state circuitry. The power necessary to light the bulb is more than many solid-state circuits were designed to handle. Components will be destroyed in the process of testing them. See Figure 7.42.

IMPORTANT: Do not use a test light on a Z-Force-S mower. It can damage the RMC module.

IMPORTANT: If a test light is used at all, it should have “**high-impedance**”, indicating that it only takes a sample of the electricity being tested, and illuminates an LED to indicate the presence of power.

NOTE: Some high impedance test lights are capable of indicating whether the current being sampled is AC or DC.

Self-powered continuity lights

Continuity lights can indicate whether a circuit is complete or not, but they give no indication of resistance. They are handy for finding point-break when static-timing some older engines, but have largely been replaced by DMMs.

There are some powered high-impedance test lights on the market that have a continuity feature, and some technicians like the fact that they can be less bulky than a DMM.

Battery Jumper Cables

The obvious use of jumper cables is to jump-start equipment to get it into the shop.

NOTE: This is not recommended for any fuel injected Kohler-powered equipment.

A clever use of jumper cables: If the technician suspects that there is resistance on the ground side of the system, a quick-and-dirty test can be made using jumper cables.

- Connect one cable clamp to the negative post of the battery, and connect the clamp at the other end of the same cable to the engine block.
- If there is an immediate difference in starter motor performance, use the voltage drop technique discussed later in this section to identify the source of the resistance.

Z-Force-S

Ammeters and specialized charging system testers

Inductive ammeters are available in many forms. Some are as simple as a gauge to be held against the circuit in question when it is energized. The operating principle is based on magnetic field induced by the current flow. See Figure 7.43.

There are two primary reasons to measure amperage. The first is to check the output of a charging system or battery. The second is to check the performance of a component that draws a substantial flow of power, typically a motor or clutch.



Figure 7.43

Briggs and Stratton sells a DC Shunt that converts amperage into a reading on the millivolt scale of a DMM. Briggs and Stratton part # 19359 covers low amperage systems, while part # 19468 tests higher amperage systems. The operating principle is based on Ohm's Law, as described earlier in this section. See Figure 7.44.

NOTE: Usage of the DC Shunt tool is detailed in the 1995 and 1999 editions of their Update Seminar materials.

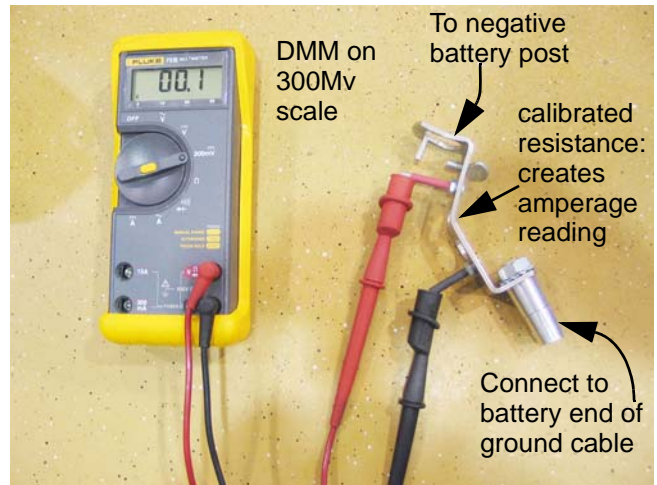

Figure 7.44

Batteries



Batteries produce flammable and explosive gases, particularly during charging.

- Do not smoke or allow an open flame or heat source near the battery.
- Charge batteries in an open area
- Wear eye protection and acid resistant gloves when handling batteries.
- Do not allow direct metal contact across the posts. This will produce extreme heat that may cause direct burns or ignite flammable gas.

California Proposition 65 warning: Battery posts, terminals, and related accessories contain lead and lead compounds. These chemicals are known in the State of California to cause cancer and reproductive harm. Wash hands after handling

NOTE: The batteries used in Current Cub Cadet equipment are sealed. It is not possible to check, test or add fluid.

Batteries contain electrolyte, which is highly corrosive. If a battery is ruptured, neutralize the electrolyte with baking soda, then carefully rinse the effected area with water.

A fully charged battery that is in good condition is an important factor when trying to diagnose other parts of an electrical system:

- Some charging systems do not work if the system voltage falls below 6V. It takes a certain amount of voltage to excite the fields in the alternator.
- Some solid-state components will not work if the system voltage falls below a given threshold.
- Some solid-state components can be damaged by the jump starting that accompanies operation with a dead battery.
- Many electric PTO clutches will fail to work dependably if battery needs to be replaced. Even though the charging system produces enough output to drive the clutch, it is over taxed driving the clutch and forcing a charge into a damaged battery.
- Continued operation with a weak battery over taxes the charging system.

Charging the battery

NOTE: It is best to remove batteries from equipment for charging to minimize corrosion from out-gassing during charging.



When disconnecting or removing the battery, disconnect the ground cable first. When reconnecting or installing a battery, connect the ground cable last. These steps will minimize the chance of shorting-out the battery posts with a tool.

1. Batteries on most modern outdoor power equipment are 12 volts so set the charger to 12 volts.
2. Set the charge rate to 2 amps.



Never charge an outdoor power equipment battery at a rate higher than 2 amps. Damage to the battery will result.

Never attempt to charge or jump a frozen battery.

3. Charge the battery until it is fully charged. Most battery chargers have an amp gauge to show the charging rate. When the gauge is at zero, stop charging the battery.

Z-Force-S

Checking battery condition

There are three things to do when testing a battery:

- Visual inspection
- Electrolyte test
- Operational test

1. Visual inspection

- Inspect the battery and battery connections for corrosion. Clean if necessary. Neutralize acid with baking soda, and protect the terminals once they are cleaned.

NOTE: Battery cable corrosion is the most common type of increased resistance circuit failures.

- Inspect the battery case for signs of damage and missing vent caps. Battery cases that bow out in the middle indicate that the battery froze or over heated and should be replaced.

2. Check the electrolyte level if the caps can be removed. Fill as needed with distilled water. After initial charging, do not add electrolyte to the battery.

3. Hydrometer test (non-sealed batteries only)
See Figure 7.45.

 CAUTION	Always wear eye protection and acid resistant gloves when working with electrolyte. Use baking soda to neutralize any spilled acid.
--	---

- 3a. Give the battery at least ten minutes for the electrolyte to stabilize after charging the battery or adding water to the cells.
- 3b. Measure the temperature of the electrolyte in the middle cells of the battery.
- 3c. Squeeze the bulb on the hydrometer, then insert the hose into the cell.
- 3d. Release the bulb, drawing electrolyte into the hydrometer to the fill line.

IMPORTANT: Hold the hydrometer straight up and down when drawing up the electrolyte. The float needs to float free, not rubbing against the sides of the hydrometer.

3e. Write down the specific gravity of each cell.

- 3f. The readings must be corrected for the temperature of the electrolyte. The hydrometer manufacture should list the temperature the float is calibrated to. Most are calibrated to 80°. To correct the reading, add 0.004 to the reading for every 10° above the calibrated temperature or subtract 0.004 for every 10° below the calibrated temperature.

3g. Compare the reading to the chart to the left.

IMPORTANT: To prevent damage to the charging system disconnect the battery to charge it.

NOTE: If battery needs to be charged, let battery sit for ten minutes to stabilize after charging. Apply a load to the battery for 15 seconds to remove the surface charge. Then re-check the battery.

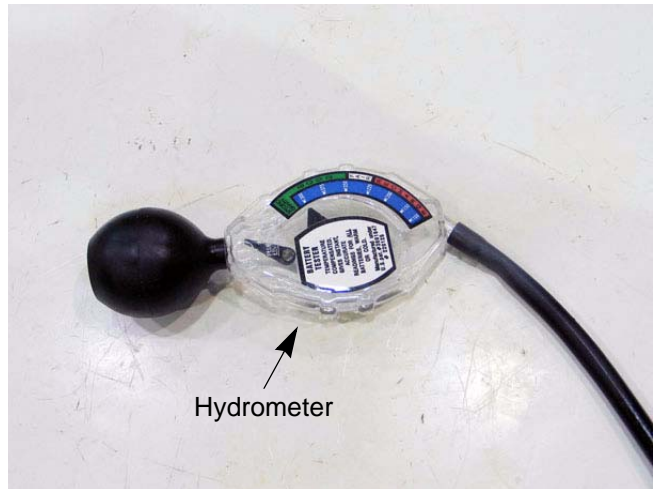

Figure 7.45

Specific Gravity	Charge Condition
1.265	Fully Charged
1.225	75% Charged
1.190	50% Charged
1.155	25% Charged
1.12	Fully Discharged

Battery Testers

There are four major ways to check a battery:

- Electrolyte test using a specific gravity tester (hydrometer) to compare the density of the electrolyte in a fully charged battery to the density of water (water = 1.0 s.g.).
- Electrolyte test using a refractometer to check the density of the electrolyte by measuring the degree to which light waves bend when passing through the electrolyte.
- Load test that checks the output of the battery after the fully charged battery has done a certain amount of work. Fixed load testers are commonly available. Variable load testers are not generally found in outdoor power equipment repair shops.
- Capacitance test that checks the ability of the battery plates to hold a charge.

Adjustable load testers

Adjustable load testing is used if an adjustable load tester is available. Follow the procedures specified by the manufacturer of the tester to connect to the battery.

Electrolyte Temperature	Minimum Required Voltage
≥70 deg. f. (21 deg. c.)	9.6 V
60 deg. f. (16 deg. c.)	9.5 V
50 deg. f. (10 deg. c.)	9.4 V
40 deg. f. (4 deg. c.)	9.3 V
30 deg. f. (-1 deg. c.)	9.1 V
20 deg. f. (-7 deg. c.)	8.9 V
10 deg. f. (-12 deg. c.)	8.7 V
0 deg. f. (-18 deg. c.)	8.5 V

1. Disconnect the battery cables.

IMPORTANT: Disconnect the negative cable first to help prevent a shorting hazard.

2. Measure the temperature of the electrolyte.
3. Connect a voltmeter and the load tester to the appropriate terminals.
4. Hook an amp probe onto the ground lead of the load tester.

NOTE: A shunt can be used in place of the amp probe, but a second voltmeter will be needed to get a measurement from the shunt.

5. Apply a load equal to 50% of the battery's rated CCA for 15 seconds.

NOTE: CCA stands for cold cranking amps. The rating should be on the battery for aftermarket batteries. For OEM batteries, contact the manufacturer for the CCA rating. Most riding mower batteries are 200-275 CCA.

6. Record the voltage while the load was applied. Compare the voltage to the above chart:
7. If the battery voltage is above what is listed in the chart, the battery is good.
8. If the battery voltage is below what is listed in the chart, replace the battery.

Z-Force-S

Fixed load testers

Fixed load testers (sometimes called toasters) are inexpensive load testers found at any auto parts store. See Figure 7.46.

NOTE: Because they have a fixed load value, they do not give most batteries a reliable and safe load test. Most fixed load testers have a load that is more than 50% of the rated CCA of riding mower batteries. This makes them inappropriate to use on smaller pieces of outdoor power equipment.

1. Disconnect the battery cables, ground first.
2. Measure the temperature of the electrolyte in the middle cells.
3. Connect a voltmeter and the load tester to the appropriate terminals.
4. Apply the test load for 15 seconds. Monitor the meter on the load tester for the battery's performance.
5. Refer to the manufacturer of the test on how to read the test meter.
6. The results of this test are not accurate and should only be relied on if the battery fails badly.

NOTE: Do not use any fixed load tester on a battery under 200 CCA. Doing so can boil the water out of the battery and damage the plates in the battery.



Figure 7.46

Conductance testers

There are several brands of conductance battery testers presently on the market. Conductance battery testers use the battery being tested as their power source. These testers send a small AC signal through the battery to measure the capacity of the plate to hold a charge.

Conductance testers are very easy to use and are far less damaging to the battery being tested. For these reasons, conductance battery testing is the preferred method of battery testing.

NOTE: Contact the manufacturer of the tester being used for specific test procedures.

1. Connect the tester to the battery.
2. Set the tester to the CCA rating of the battery.
3. Initiate the test.
4. Read the display of the tester. The tester's display will indicate if the battery passed or not. See Figure 7.47.

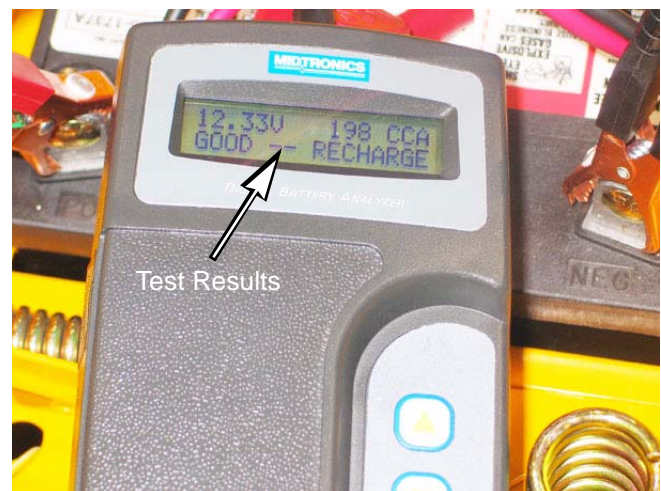

Figure 7.47

Battery discharge test



Figure 7.48

Occasionally a battery will discharge while sitting unused. To test for a battery that is “leaking” voltage:

1. Confirm that operator technique is not creating a situation that causes a draw. As an example, if a homeowner habitually turns their equipment off using a safety switch (perhaps vacating the seat with the key switch still ON), that may leave a relay or fuel shut-off solenoid energized.
2. Disconnect and charge the battery fully.
3. Use the ammeter function of a DMM to check for a power draw between the negative post on the battery and the end of the ground cable that normally connects to it. There should be no significant D.C. Amperage flow. See Figure 7.48.
4. A spark jumping from the post to the cable end is an indication that there is a substantial current draw, but should not be used repeatedly as a diagnostic tool. This is an extremely unkind thing to do to any electronic components of the mower.
5. Once the presence of a draw is confirmed, disconnect components of the system one at a time while monitoring an ammeter to see which makes the draw stop.
6. If the battery is being checked independently of the equipment it powers, measure and note the battery voltage while it is disconnected, over a three-day period.
7. There should be less than a 0.2 volt drop in the readings. If there is more than a 0.2 volt drop, the battery is bad.

Storage of batteries

1. Always store a battery with a full charge. This may require periodic re-charging.
NOTE: This does not apply to a dry battery that has not had the electrolyte added to it yet.
2. Take measures to prevent the battery from freezing in cold weather. The electrolyte in a fully charged battery has a lower freezing point than the electrolyte in a battery with a lower state of charge.
3. Store the battery in a cool, dry place.
4. If storing multiple batteries (primarily store stock), rotate the stock so that the oldest battery goes out first. This will increase the life of the batteries.

Z-Force-S

Electrical Troubleshooting

1. The first step in troubleshooting is to always verify the complaint. Defining and verifying the problem reduces the possibility of misunderstanding and helps clarify the diagnostic approach.

2. The next step is to check the simple stuff first:

- Check the fuse or fuses:

NOTE: Failure of any fuse is an indication that there is a problem of some sort in the circuit that the fuse protects.

- Look for obvious physical damage.
- Use the hour meter and indicator lamps as a guide to direct the search. As an example, when diagnosing a “no-crank” condition on a Z-Force-S mower: if the PTO light is lit on the hour meter but the technician has visually verified that the PTO clutch is not engaged, the PTO circuit would be a reasonable place to check for problems.
- Check the battery:

IMPORTANT: A valid diagnosis of many systems cannot be made without full system voltage applied.

3. Take a methodical approach to finding the problem. As a rule of thumb, start at one end of the circuit and work to the other.

4. The next step is to decide what method to use to troubleshoot the circuit.

- If checking a safety circuit that grounds the magneto, use an Ohms meter to test for continuity.
- If checking a safety circuit that enables a starter motor or accessory, use a volt meter to confirm the presence of power at each junction in the system.
- If a circuit does not work at all, look for a short or an open.
- If the circuit works slowly or intermittently, look for resistance by doing a voltage drop test.

NOTE: In all diagnosis, it is very important to understand the circuit that is being checked. The use of a schematic is recommended, even if a technician is thoroughly familiar with the system.

5. Testing for opens/shorts

NOTE: When checking circuits for continuity, disconnect the circuit at the nearest plug and use the metal terminals of the plug as a connection point for the test probes. **DO NOT STAB THE WIRES.**

NOTE: When checking circuits for voltage, back-probe the terminals nearest the point to be checked. **DO NOT STAB THE WIRES.**



Figure 7.49

6. Starting with a fully charged battery and battery cable connections that are clean and tight, measure the battery voltage. See Figure 7.49.
7. With the circuit energized, start at either end of the circuit and check for voltage.
 - If starting at the battery end of a powered circuit, trace it through until power vanishes.
 - If starting at the ground end of a powered circuit, trace it through to the point that power appears.
 - If there is low voltage at the far end of the circuit, do a voltage drop test (as described later in this section) on the circuit to find the source of resistance.

NOTE: When working toward the battery, check each junction with the connector disconnected, then re-check it with the junction reconnected. If there is voltage with the connector unplugged but not when it is connected there is a short between that point and the last connector tested.

NOTE: When working toward the battery, if one junction has lost power, but the next connector has voltage with its junction still connected, there is an open between the two junctions.

8. Continue checking each connector until the other end of the circuit is reached or the fault is found.

Z-Force-S

Voltage Drop Test

To review:

- Ohm's law states that it takes voltage to push current through a resistance.
- Kirchoff's voltage law states that the sum of all the voltage drops equals the source voltage.
- Combining those two laws, we see that any restriction in a circuit (e.g.: loose connector, damaged wire, or corroded terminal) will use up some voltage as the current is pushed through.
- A voltage drop test is a way of looking for that voltage.
- Because electricity needs to complete a full circle (circuit), voltage drop tests are useful on both the positive or the negative side of the system.
- This text will address the negative side to begin with. Bad grounds are responsible for as many electrical failures as the positive side of the system, yet the ground side is frequently neglected by technicians. See Figure 7.50.



Figure 7.50

NOTE: Ultimately, all current will find its way back to the negative post of the battery.

To check ground-side voltage drop: set-up a multimeter to measure 12V DC.

1. Make a good electrical connection between the black (-) probe and the negative post on the battery.
2. Make a good electrical connection between the red (+) probe and the suspect point of ground.
3. Power-up the circuit in question.
4. The voltage that shows-up on the meter is the voltage that is being used to pass current through a resistance in the circuit.
5. Voltage drop on a good circuit should be less than 0.1 volts. A voltage drop reading on the meter of greater than 0.2 volts indicates a fairly substantial problem that demands attention.

- As an example, if the starter solenoid does not engage properly, check for voltage drop between the ground point for the starter solenoid and the negative post on the battery. See Figure 7.51.
- With the starter engaged, this machine exhibited a voltage-drop reading of 0.308 volts, indicating a poor ground connection.



Figure 7.51



Figure 7.52

A similar ground-side test on a mower with a slow-cranking starter motor can be conducted between the engine block and the negative battery post. See Figure 7.52.

1. With the starter engaged, this machine exhibited a voltage-drop reading of 0.312 volts, indicating a poor ground connection.
2. Individually, these readings should lead a technician to inspect the connection between the solenoid and the ground path on the first mower (e.g. mounting hardware, green wire with eyelet beneath head of solenoid mounting bolt), or the engine and the frame on the second mower (e.g. loose or rusty engine mounting bolts).
3. If both of these readings were found on the same mower, a common point in the system would be the primary suspect (e.g. poor connection between negative battery cable and frame).



Figure 7.53

Applying this principle to the positive side of the system:

IMPORTANT: Ultimately, all positive current will find its way from the positive post of the battery to the negative post.

1. To check hot-side voltage drop: set-up a multi meter to measure 12V DC. See Figure 7.53.
2. Make a good electrical connection between the red (+) probe and the positive post on the battery.
3. Make a good electrical connection between the black (-) probe and the suspect point of the circuit.
4. Power-up the circuit in question.
5. The voltage that shows-up on the meter is the power that is not following the intended path back to the negative battery post.

Z-Force-S

6. Voltage drop on a good circuit should be less than 0.1 volts. A voltage drop reading on the meter of greater than 0.2 volts indicates a fairly substantial problem that demands attention.

- As an example, if the mower had a slow-turning starter, the ground-side voltage drop measured below 0.1 volts, and there was not a parasitic load on the engine (e.g. PTO clutch that is not fully disengaged), it would be logical for the technician to check voltage drop to the starter. See Figure 7.54.
- With the starter motor engaged, the voltage drop reading here is nearly 0.6 volts, indicating a serious problem in the heavy-gauge circuit between the starter and the battery.
- Checking voltage-drop at various points along the circuit can help pin-point the problem.
- Check voltage-drop at the output lug on the starter solenoid:
- If there is a significant difference, the problem lies between the lug on the solenoid and the lug on the starter.
- If there is little change, the problem lies further up-stream.
- Check voltage drop at the input lug on the solenoid. If there is significant difference between the reading here and the reading at the output lug (greater than 0.10 volt), then the contacts inside the solenoid may be burned. If there is little change, the problem lies further up-stream, between the battery and the solenoid.
- Results may be cross-checked by testing voltage drop across the two posts of the starter solenoid while cranking the starter motor.



Figure 7.54

Testing switches

- Refer to the “COMPONENTS” section of this chapter that describes the function of the individual switches to be tested.
 - Switches can be tested “hot” by looking for voltage at the appropriate posts. This is not definitive, since the source of the voltage is not always confirmed. Checking for voltage does not work on switches that work by providing a ground path to the magneto primary windings or a solid state control device.
 - The most valid way to test switches is a continuity test.
1. Understand the internal functions of the switch. Key switches and PTO switches can be fairly complex.
 2. Isolate the switch from the rest of the circuit.
 3. Test each pair of terminals for continuity in all modes of switch operation: at-rest, and actuated.
 4. Many switches on Cub Cadet equipment are typed by their at-rest state: Normally Open, Normally Closed, Common.

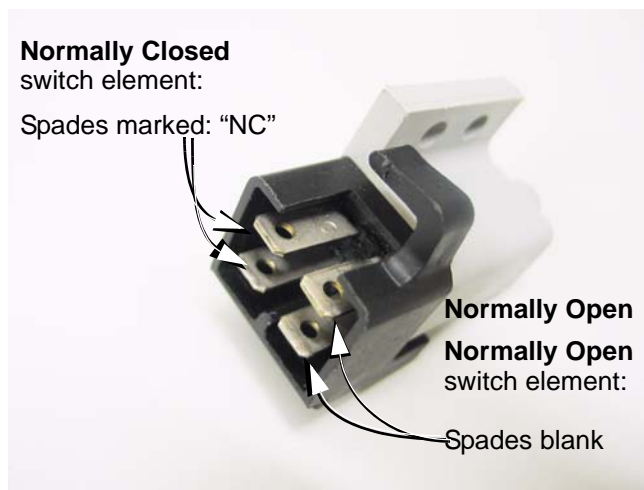

Figure 7.55

- Normally Open (N.O.) contacts do not complete a circuit when the switch is at-rest (plunger extended). They close to complete a path through the switch when the plunger is depressed.
- Normally Closed (N.C.) contacts complete a circuit when the switch is at-rest (plunger extended). They open to break the path through the switch when the plunger is depressed.
- Some Cub cadet switches contain more than one pair of contacts. The same switch housing can contain normally open and normally closed switch elements.
- When testing a switch that contains more than one set of contacts (elements), the male spade terminals associated with Normally Closed contacts will be stamped “N.C.”
- The male spade terminals that are associated with each-other face each-other broad-surface to broad surface. See Figure 7.55.

Z-Force-S

Diodes

What is a diode? A diode acts like a one way valve, allowing current to flow in only one direction. See Figure 7.56.

- Which way does this electrical check-valve work? There will be a band on one end of the diode. The band indicates the negative side of the diode
- Most DMMs have the ability to test a diode.

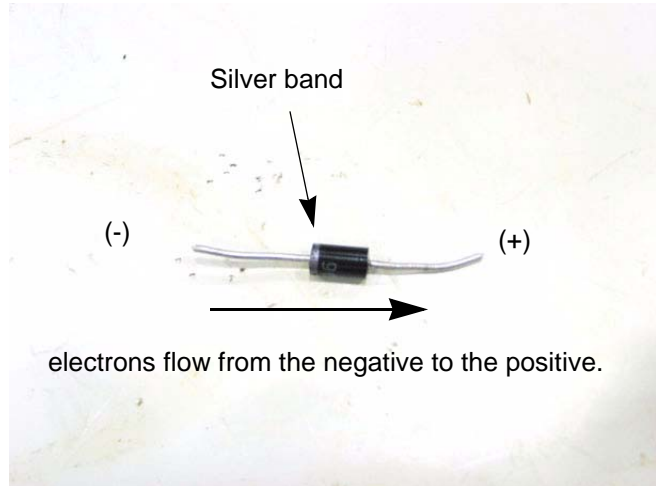

Figure 7.56

Testing a diode:

1. Isolate the diode in the circuit.
2. Set the DMM to the diode or Ω scale. See Figure 7.57.
3. Attach the negative lead of the DMM to the side of the diode with a band on it.
4. Place the positive lead on the other side of the diode.

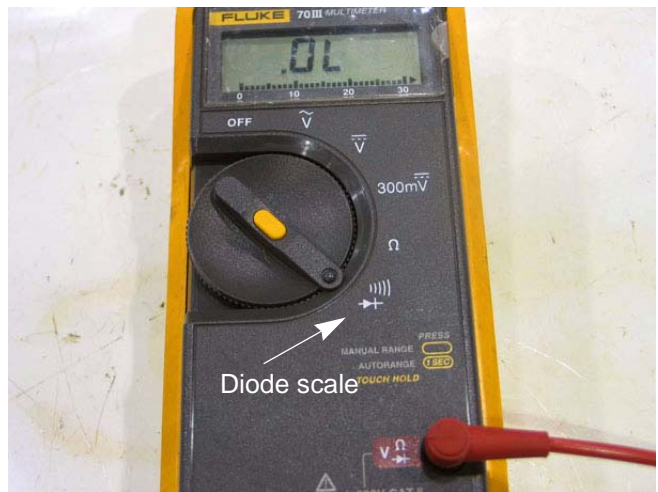

Figure 7.57

5. There should be continuity. See Figure 7.58.



Figure 7.58

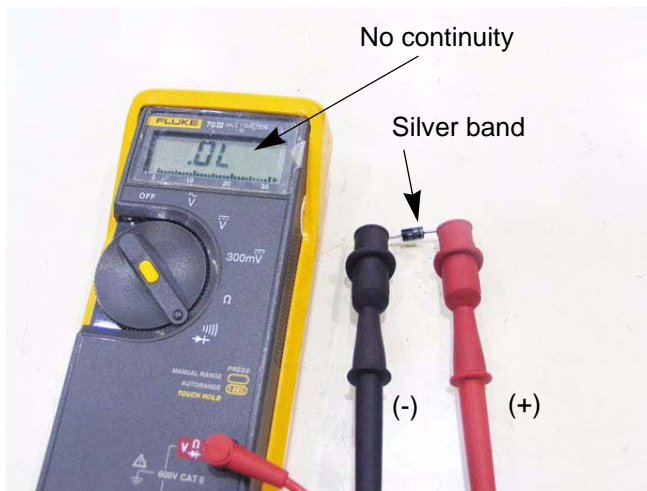

Figure 7.59

6. Switch the leads and repeat the test.
7. The meter should indicate no continuity. See Figure 7.59.
8. If the results do not match the above, replace the diode.

Z-Force-S

Relay

Most of the relays used by MTD or Cub Cadet have five pins. See Figure 7.60.

- Windings: Terminals 1 & 2 are the outer-most of the row of three small spade terminals. When one has power and the other is connected to ground, the relay is energized.
- Normally, a resistance reading between terminals 1&2 will produce a measurement of about 100Ω . This is the resistance in the windings around an iron core that energize an electromagnet or a solid-state equivalent.
- Terminal 3 is a "Common" connection. It may be connected to power or ground, depending on the application. It is the large spade terminal near the edge of the relay.
- Terminal 4 is the "Normally Closed" contact. When the relay is not energized, terminal 4 is connected to terminal 3. When the relay is energized, this connection breaks. An Ohm meter should show zero resistance or " 0.0Ω " between 3 & 4 when the relay is at rest, and it should read no continuity when the relay is energized.
- Terminal 5 is the "Normally Open" terminal. It connects to terminal 3 when the relay is energized. When 3 & 4 are connected, 3 & 5 are disconnected, and vice-versa. An Ohm meter should show zero resistance, or " 0.0Ω " between 3 & 4 when the relay is at rest, and it should read no continuity when the relay is energized.

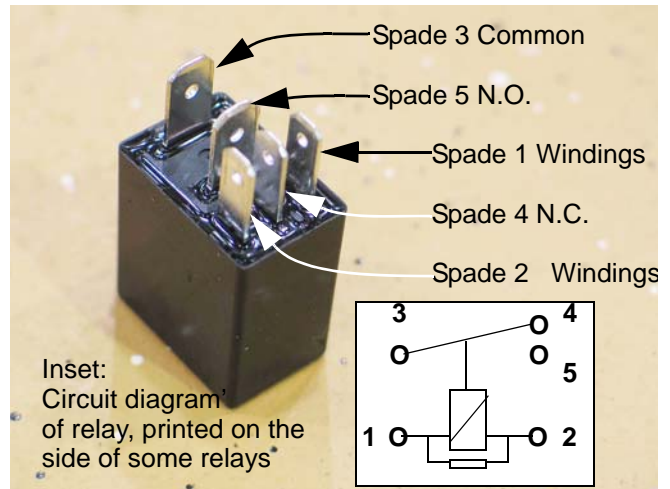

Figure 7.60

To test a relay

1. Test for continuity between the common and the NC terminals using a DMM.
2. Test for continuity between the common and the NO terminals using a DMM.

NOTE: There should be continuity with the NC terminal and no continuity for the NO terminal. If the results vary from this the relay is bad.

3. Apply 12 volts to terminals 1 and 2. This will active the relay.
4. Test for continuity between the common and the NC terminals.
5. Test for continuity between the common and the NO terminals.

NOTE: There should be no continuity with the NC terminal and continuity with the NO terminal. If the results vary from this the relay is bad.

NOTE: To test the relay for burned contacts, do a voltage drop test across the relay contacts while the circuit is being used.

Schematic

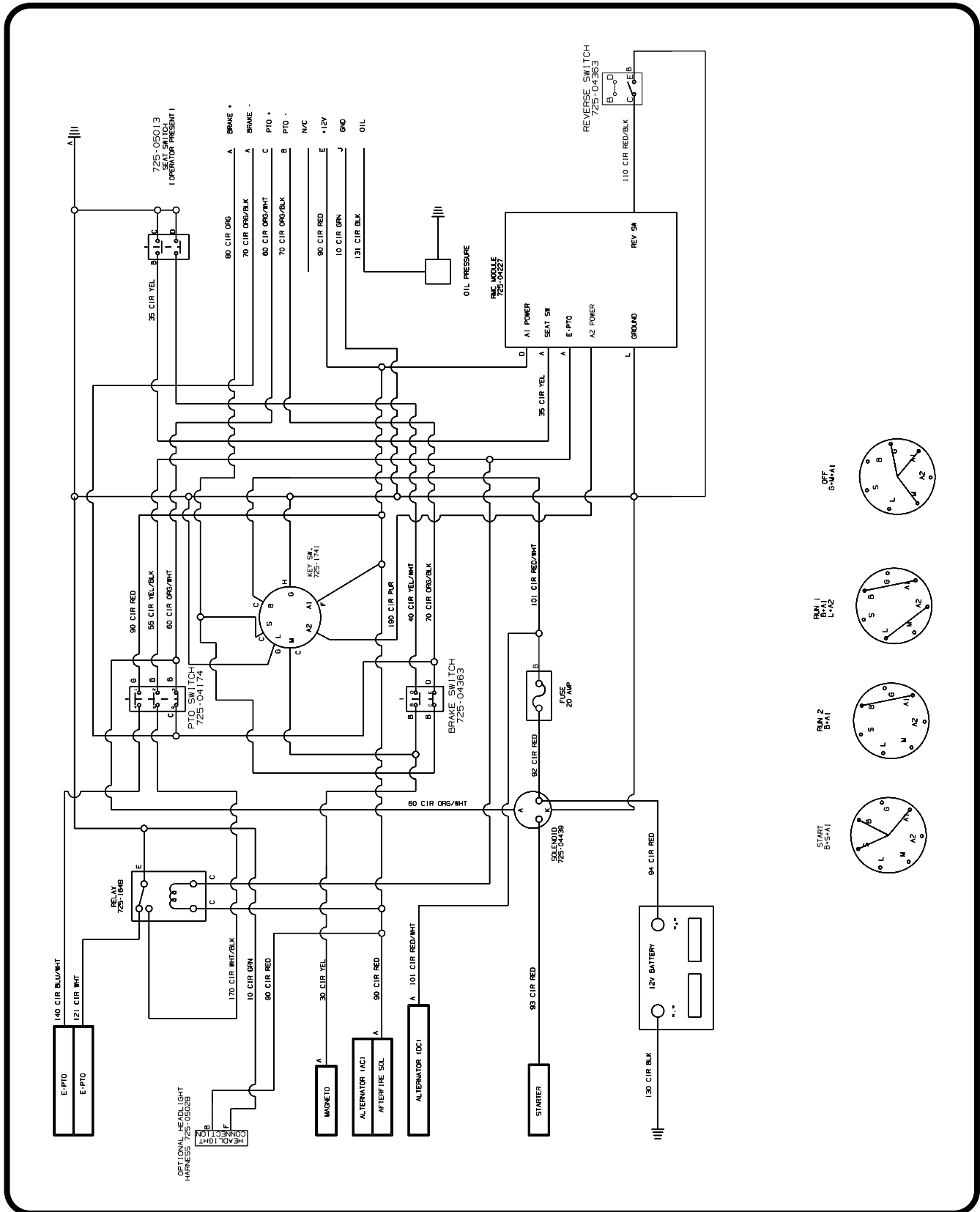

Z-Force-S

Headlight harness

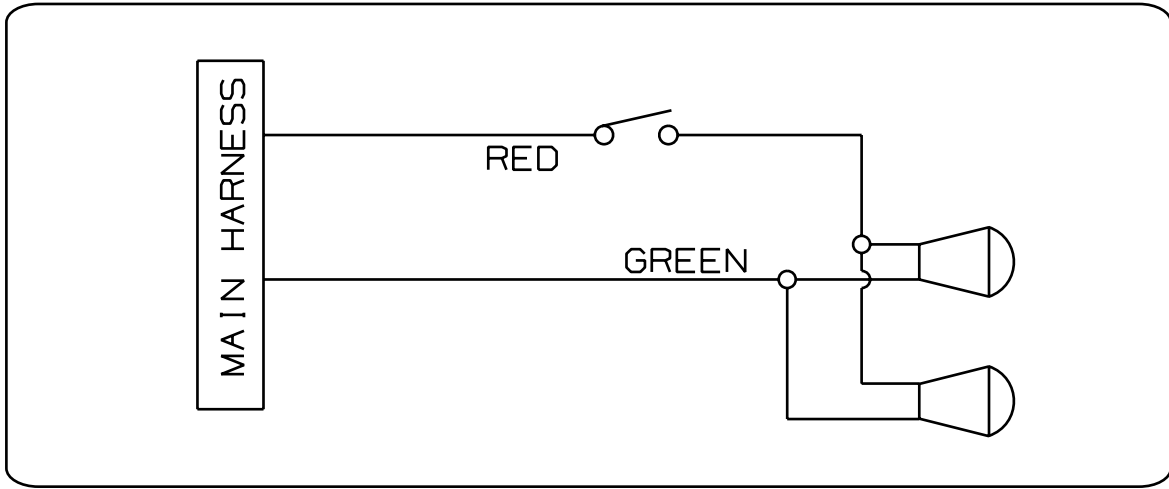

CHAPTER 8: DECKS AND LIFT SHAFT

Cutting decks

The Z-Force-S comes with the option of a 46" or 60" floating deck. The decks are made of 11-gauge steel and feature welded construction and a sloped noses. The procedure to remove the deck is the same for both of them.

To remove the deck:

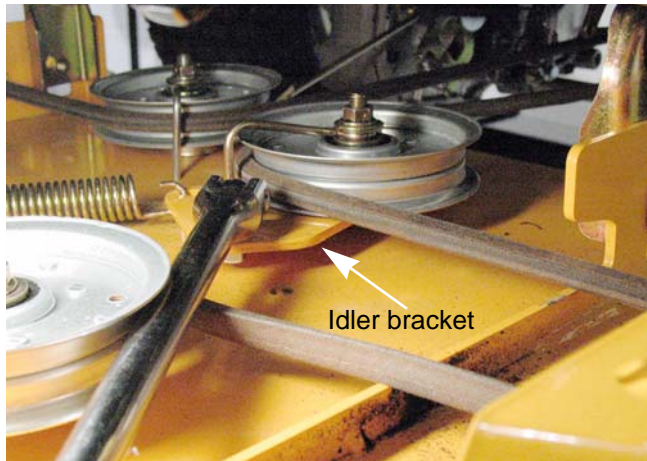

Figure 8.1

1. Place the mower on firm level ground and set the parking brake.
2. Raise the deck to its highest cutting height.
3. Insert a 1/2" drive breaker bar into the square hole in the deck idler bracket. See Figure 8.1.
4. Pull the breaker bar towards the rear of the mower to remove some of the belt tension.
5. Slide the belt off of the PTO clutch.

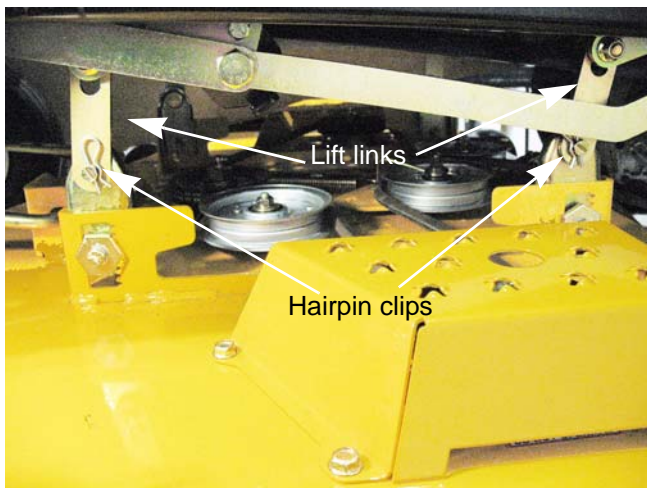

Figure 8.2

6. Pull the hairpin clips out of the four deck lift adjustment brackets. See Figure 8.2.
7. Slide the deck forward and unhook the U-Rod from the front of the deck.
8. Slide the deck out to the right, from underneath the mower.
9. Install the deck by following the above steps in reverse order except the belt. The belt goes on the PTO clutch last.

Z-Force-S

Cleaning the deck

Cleaning debris off of the deck should be done every time the mower is used. It is routine maintenance that will make the deck easier to work on and prolong the life of the deck and spindles.



Debris build up on the mower deck is an unsafe condition. The debris traps heat in the spindles causing damage to the spindle bearings. Debris around the belt can over-heat.

To clean the deck while it is removed:

1. Blow all the debris off of the top of the deck using compressed air.
2. Scrape off the debris build up from the under side of the deck using a plastic scraper.

NOTE: Applying a light coating of oil to the underside of the deck after scraping it clean will help prevent rusting of the deck and help keep the debris from building up on the underside of the deck.

Blades

The condition of the blades will greatly effect the quality of the cut. The blades should be sharpened and balanced after every five acres, depending on local conditions. A dull blade tears the grass instead of cutting it. Torn grass blades leaves a rough look and makes the grass vulnerable to diseases.

Blades need to be examined for damage before sharpening. Blades must be balanced after sharpening to minimize vibrations. Bent blades are a sign of a blade impact. If a bent blade is found, the blades must be replaced and the spindles inspected for bent shafts and cracked housings.

Blades come in a variety of styles; side discharge, mulching, bagging, combination, there are even de-thatching blades on the market. The Z-force S comes with what Cub Cadet calls a 3 in 1 blade. This means it can side discharge, bag and mulch.

The cutting deck on the Z-force S mower is mounted with a slight rake, meaning that the front of the deck is a 1/4" - 3/8" lower than the rear of the deck. This is very important to get the proper air flow in the deck so that the blades can make the grass blades stand up to get cut.

The air flow in the cutting deck is generated by the spinning blades. If the blades are mounted upside down, the air flow will be reversed pushing the grass down instead of standing up.

NOTE: Blades that are mounted upside down, increase the risk of impacting an object.



490-850-0005

Figure 8.3

To remove the blades:

1. Remove the deck as described in the previous section of this chapter or lift the mower using a professional grade lift.
2. Block the blade with a piece of wood to prevent it from spinning.

NOTE: MTD blade holding tool 490-850-0005 can be used to hold the blade while removing the blade nut. See Figure 8.3.

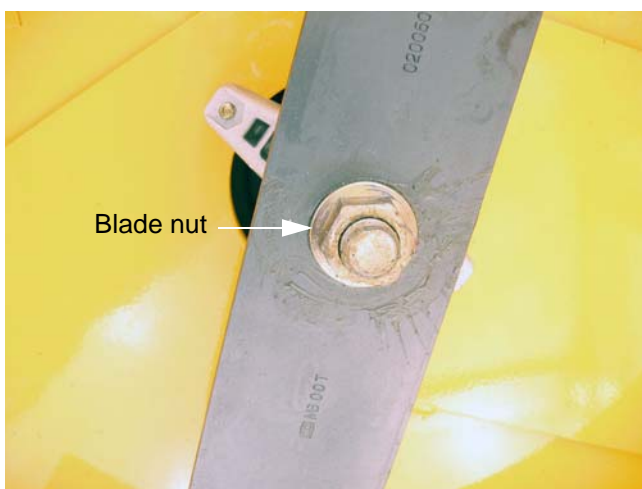

Figure 8.4

3. Remove the blade nuts using an impact wrench and a 1 1/8" socket. See Figure 8.4.



Use care around the blade while removing or tightening the nut. The blade can spin and cause an injury to the technician.

Z-Force-S

4. Remove the blade.

NOTE: The blade spacer and a bearing protector will come off with the blade. The bearing protector and the spacer must be installed in the same order when installing the blade. See Figure 8.5.

5. Install the blade by following the above steps in reverse order. Tighten the blade nut to a torque of 100 - 120 ft-lbs (136 - 163 Nm).

NOTE: A 1 1/8" wrench can be used to hold the top of the spindle shaft.

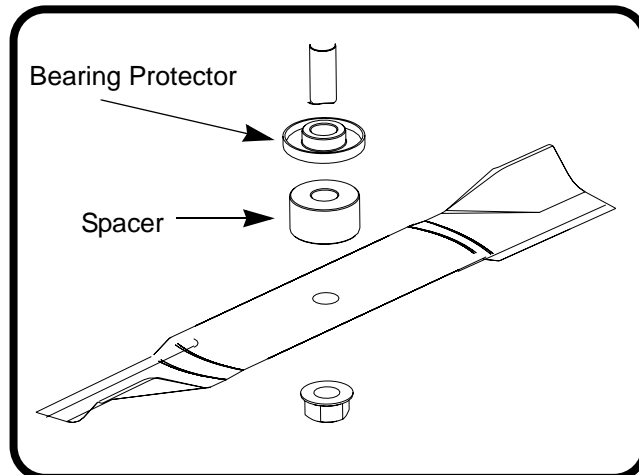

Figure 8.5

Sharpening the blades:

- To properly sharpen the cutting blades, remove equal amounts of metal from both ends of the blades along the cutting edges, parallel to the trailing edge, at a 25° to 30° angle.
- Sharpen the top of the blade only, maintaining the factory cutting edge angle.

IMPORTANT: It is important that each cutting blade edge be ground equally to maintain proper blade balance.

IMPORTANT: Replace any blade with severe nicks or dents that cannot be removed by filing.

- The blade can be tested by using a blade balancer. Grind metal from the heavy side until it balances evenly.



A poorly balanced blade will cause excessive vibration and may cause damage to the mower and result in personal injury.

PTO belt

Some cutting deck designs use a single belt to transfer power from the engine crankshaft directly to the blade spindles.

Other cutting deck designs use one belt to transfer power from the engine crankshaft to a second belt that drives the blade spindles.

On decks with two belts, the belt that goes around the crankshaft or PTO clutch is referred to in this text as the PTO belt. The second belt is called a deck belt.

The function of the PTO belt is to transfer the mechanical force from the engine to the blades. The belt faces a lot of different forces.

- Internal friction from the bending forces.
- The friction between the belt and the pulleys creates heat. The compression of the belt as it bends around the pulleys also creates heat. All of this heat softens the belt which weakens it.
- Every time the electric PTO is engaged, the PTO belt is subjected to a tensile impact load. When the electric PTO is engaged, it goes from 0 to 3,600 RPM instantly. This can actually remove sections of the belt.

NOTE: Engaging the Electric PTO before the mowing deck is placed into the grass will reduce the impact load on the belt.

- When a blade hits an object like a rock or a tree root, the belt is subjected to an impact load similar to, but greater than the impact load of engaging the electric PTO.
- The belt has rubber in it. as the rubber ages, it becomes brittle making it weaker.

NOTE: A damaged belt can cause the deck to vibrate when the deck is engaged. The vibration can be bad enough to simulate an engine issue.

NOTE: Not all belt damage is visible. Broken cords inside the belt are not visible to the naked eye, but can cause vibration issues and greatly reduce the life of the belt.



Cub Cadet belts are design to fit our equipment and are not standard lengths. Use of a non-OEM belt may prevent the mowing deck from working properly.

To replace the PTO belt (60" deck):

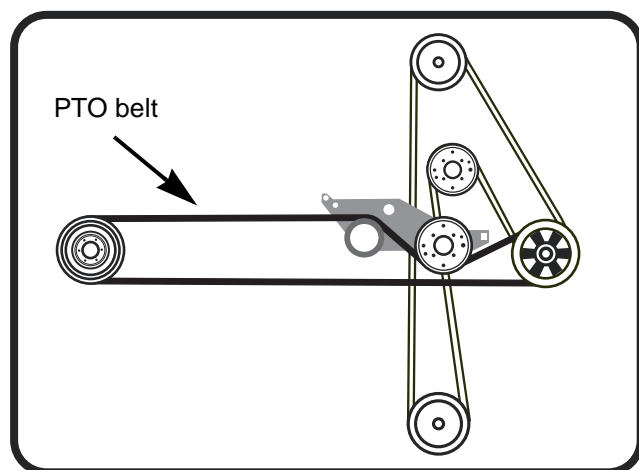

Figure 8.6

1. Remove the deck as describe at the beginning of this chapter.

NOTE: Removal of the deck is not necessary, but makes it easier to route the belt around the spindles.

2. Loosen the belt keepers enough to allow the belt to slip past them.
3. Slide the belt off of the pulleys.
4. Route the new belt around the pulleys.
5. Tighten the belt keepers.
6. Install the deck as describe at the beginning of this chapter.
7. Test run the mower before returning to service.

Z-Force-S

Deck Belt

To replace the 46" deck belt:

1. Remove the deck as describe at the beginning of this chapter.
2. Slide the belt off of the pulleys.
3. Remove the spindle covers following the steps described in the spindle section of this chapter.
4. Loosen the belt keepers enough to allow the belt to slip past them.
5. Route the new belt around the pulleys.
6. Tighten the belt keepers.
7. Install the deck as describe at the beginning of this chapter.
8. Test run the mower before returning to service.

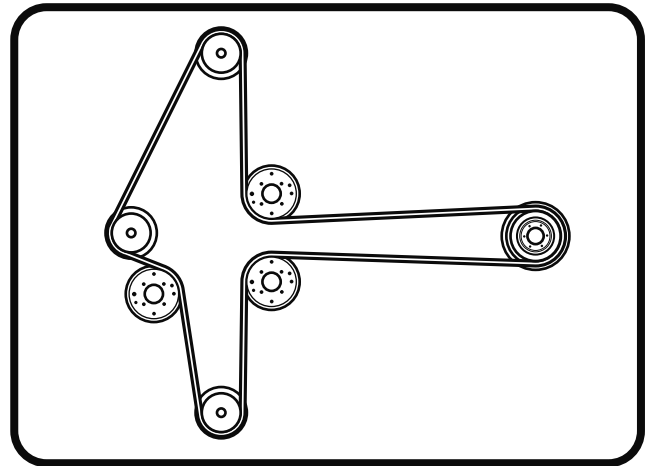

Figure 8.7

To replace the 60" deck belt:

1. Remove the deck as describe at the beginning of this chapter.
2. Remove the PTO Belt by following the procedures described in the PTO belt section of this chapter.
3. Slide the belt off of the pulleys.
4. Remove the spindle covers following the steps described in the spindle section of this chapter.
5. Loosen the belt keepers enough to allow the belt to slip past them.
6. Route the new belt around the pulleys.
7. Tighten the belt keepers.
8. Install the deck as describe at the beginning of this chapter.
9. Test run the mower before returning to service.

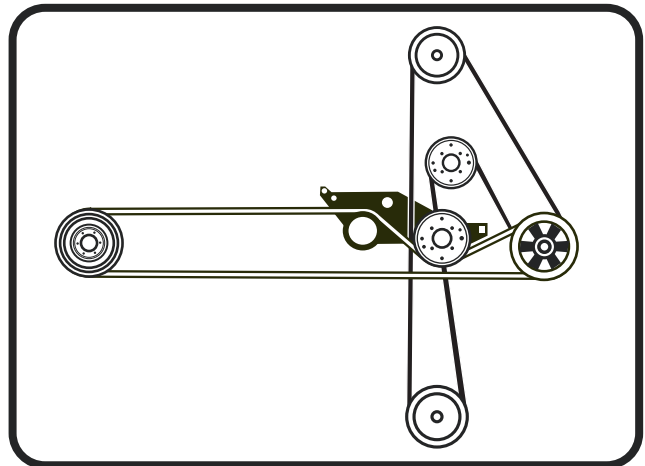

Figure 8.8

Belt tension

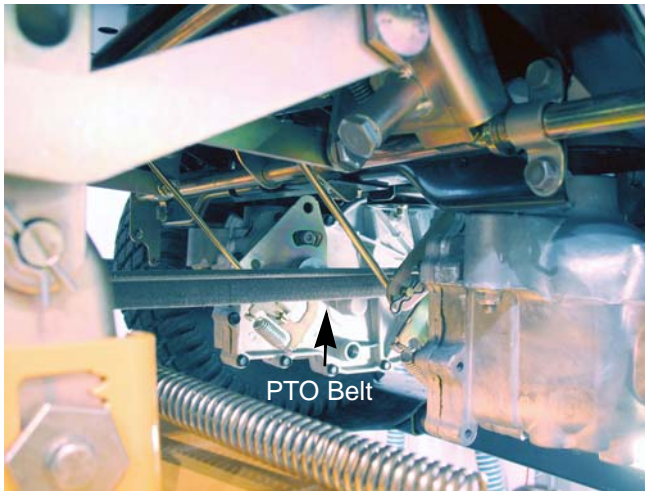

Figure 8.9

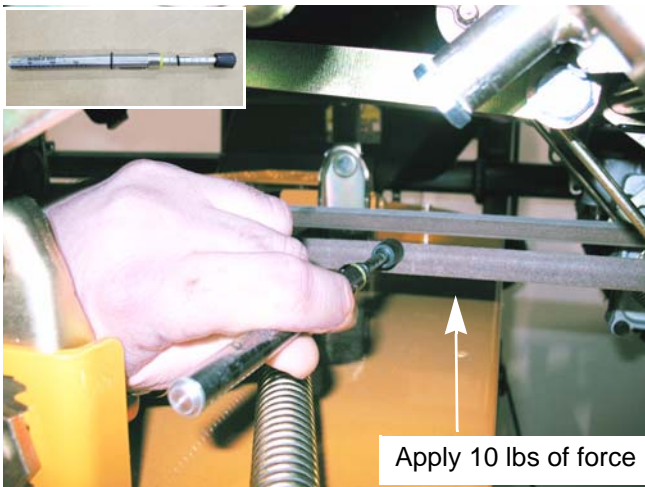

Figure 8.10

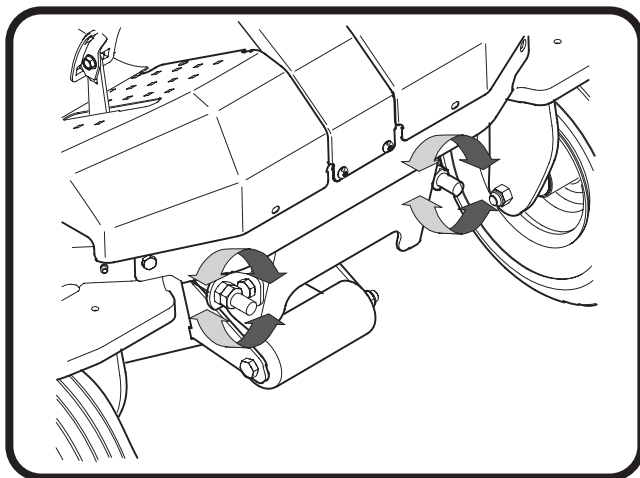

Figure 8.11

The belt tension for the PTO belt for the 60" deck and the deck belt for the 48" deck is about a 1/2" deflection of the belt with ten pounds of force applied to the belt.

To check the belt tension:

1. Locate the longest straight section of the belt. It should be the section from the PTO pulley to the deck. See Figure 8.9.

2. Apply ten pounds of force to the middle of the belt span. See Figure 8.10.

NOTE: A belt tension checker will make it easier to measure the amount of force being applied. See Figure 8.10. inset.

3. Measure the amount the belt deflects.

To adjust the belt tension:

- Tighten the jam nuts on the deck hanger U-rod to increase the belt tension.
- Loosen the jam nuts on the deck hanger U-rod to decrease the belt tension.

Z-Force-S

Spindle pulleys and spindle shafts

To replace a pulley or spindle shaft:

1. Remove the deck as described at the beginning of this chapter.
2. Slip the deck belt off of the spindle pulley that is to be serviced.

NOTE: To reach the outer spindles, remove the spindle covers. See Figure 8.12.



Figure 8.12

3. Remove the blade nuts using an impact wrench and a 1 1/8" socket.
4. Left the spindle shaft out of the spindle housing. See Figure 8.13.

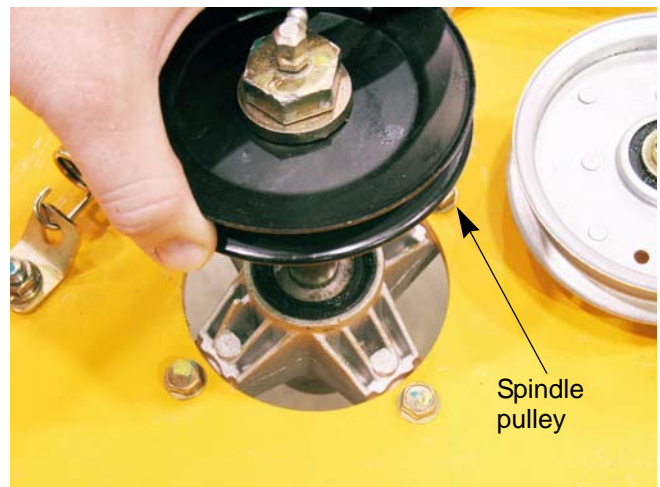

Figure 8.13

5. Remove the pulley. See Figure 8.14.
6. Install the spindle pulleys by following the above steps in reverse order.

NOTE: Tighten the blade nut to a torque of 100 - 120 ft-lbs (136 - 163 Nm).

7. Test run the mower before returning to service.

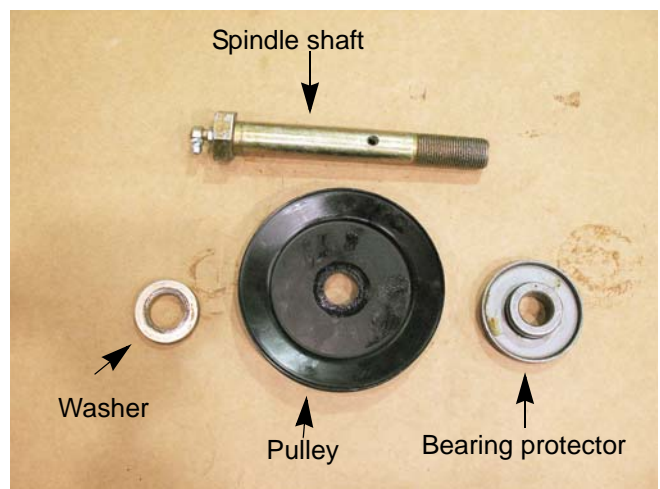

Figure 8.14

Spindle removal/installation



Figure 8.15

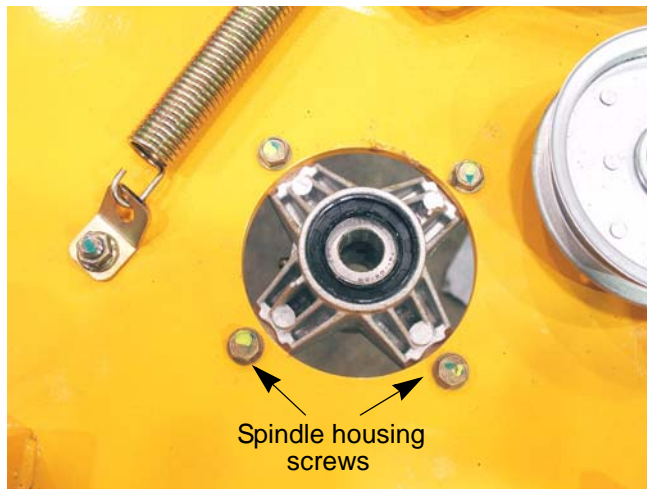

Figure 8.16

To remove/rebuild a spindle:

1. Remove the deck as described at the beginning of this chapter.
2. Remove the blade following the steps described in the blade section of this chapter.
3. Remove the spindle covers. See Figure 8.15.
4. Slip the deck belt off of the spindle pulley that is to be serviced.

5. Remove the spindle pulley.
6. Remove the four screws fastening the spindle to the deck. See Figure 8.16.
7. Lift the spindle out of the deck shell.
8. Install the spindle by following the above steps in reverse order.

NOTE: The four spindle bolts are self tapping bolts. The new spindle housing will not have threads in it.

NOTE: Tighten the spindle bolts to a torque of 200 - 300 in-lbs (23 - 34 Nm).

Z-Force-S

Spindle overhaul

To rebuild a spindle:

1. Remove the spindle by following the procedures described in the spindle removal section of this chapter.
2. Slide the spindle shaft and pulley out of the spindle housing.
3. Remove the upper bearing protector.
4. Remove the upper bearing seal. See Figure 8.17.

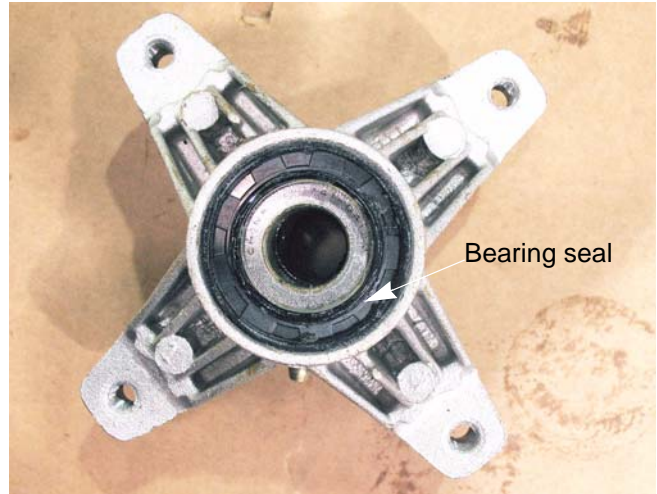

Figure 8.17

5. Remove the upper bearing.

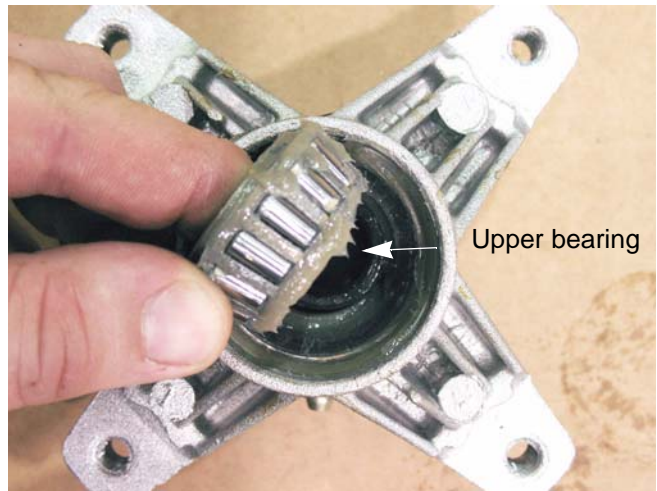

Figure 8.18

6. Remove the spacer. See Figure 8.19.

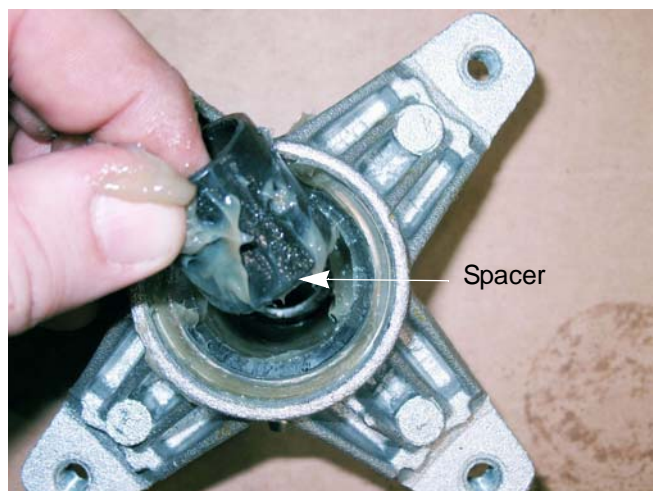

Figure 8.19

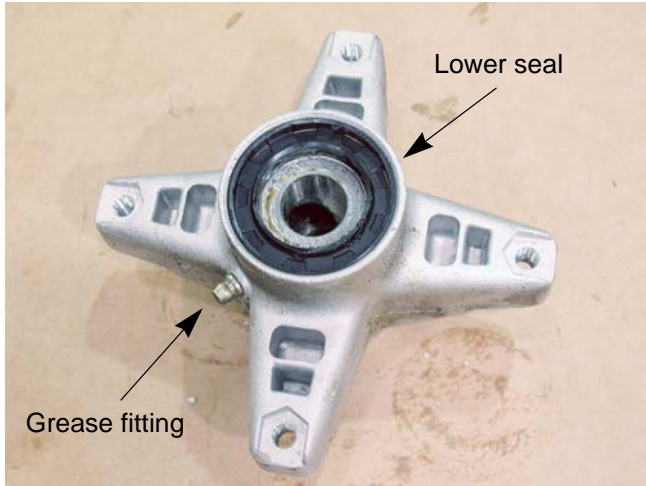

Figure 8.20

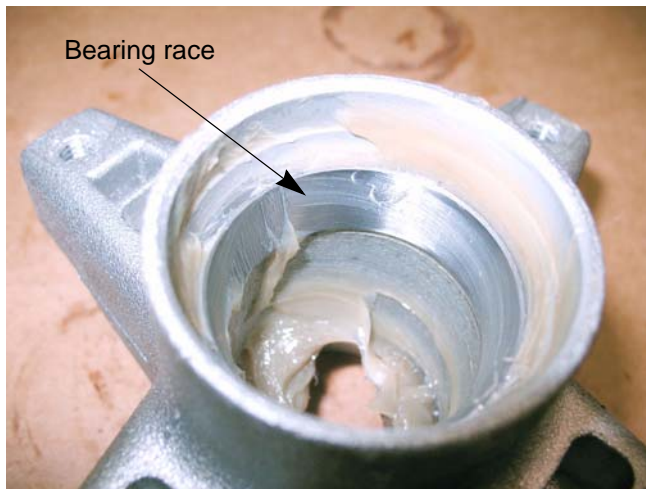

Figure 8.21

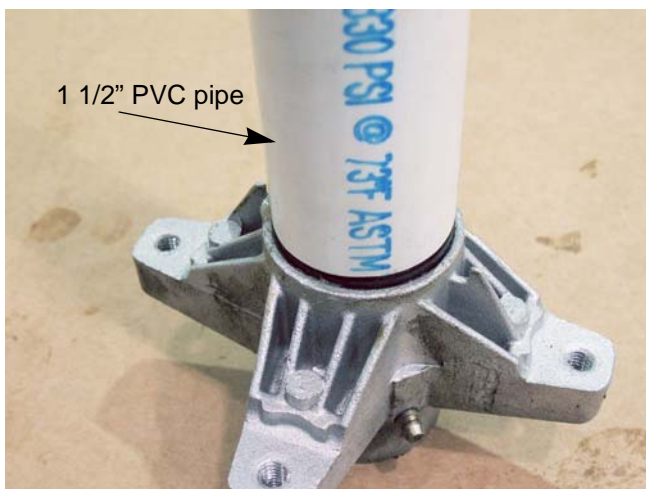

Figure 8.22

7. Remove the lower bearing seal. See Figure 8.20.

8. Remove the lower bearing.

NOTE: The grease fitting in the spindle housing and the grease fitting on the spindle shaft send grease to the same spot. Only one of the fittings needs to be used when greasing a spindle.

NOTE: Bearing races and cones must be kept as a matched set once they have been run.

- If a bearing race or cone is to be re-used, it must be re-used with its original mate.
- If a bearing race or cone is to be replaced, its mate must be replaced as well.

9. Inspect the bearing races. If they show signs of wear or damage, they must be replaced.

NOTE: A bearing race can be driven out using a drift or a pin punch.

10. Re-assemble the spindle by following the previous steps in reverse order.

NOTE: Pack the bearings with a high quality lithium grease before installing them.

NOTE: The seals are installed with the lips facing out.

NOTE: A piece of 1 1/2" PVC pipe can be used as a seal driver. See Figure 8.22.

11. Test run the mower in a safe area before returning it to service.

Z-Force-S

Leveling the deck

For the best quality cut, the deck must be level side to side and the front of the deck should be 1/4" - 3/8" lower than the rear of the deck.

To level the deck:

NOTE: Deck leveling is part of initial mower setup. Before adjusting an out of level deck on a mower that has been used, inspect all of the deck lift and suspension linkages. Move the deck through its full range of travel while checking linkage movement. Repair any damaged or binding linkage before leveling the deck.

NOTE: Check the mower's tire pressure before performing any deck leveling adjustments. The recommended operating tire pressure is:

- Approximately 10 psi for the rear tires
- Approximately 14 psi for the front tires

NOTE: When either deck level or pitch are adjusted, check both level and pitch after the adjustment has been made.

Side to Side Leveling

NOTE: When leveling the deck side-to-side, make sure the two rear adjustment gears are set in the middle of the adjustment range. See Figure 8.23.

1. With the mower parked on a firm, level surface, move the deck to the mid height or most commonly used position using the deck lift pedlar. Rotate the outside blades so that they are perpendicular with the mower frame.
2. Measure the distance from the outside of the left blade tip to the ground and the distance from the outside of the right blade tip to the ground. Both measurements taken should be equal. If they are not, note whether the left side of the deck is lower or higher and proceed to the next step.

NOTE: Use of Cub Cadet deck leveling gauge, part number 490-900-0041, will make measuring the blade tip height easier. See Figure 8.24.

NOTE: If the measurement is suspiciously uneven, rotate the blades 180° and recheck. A change in the measurement indicates a bent blade.

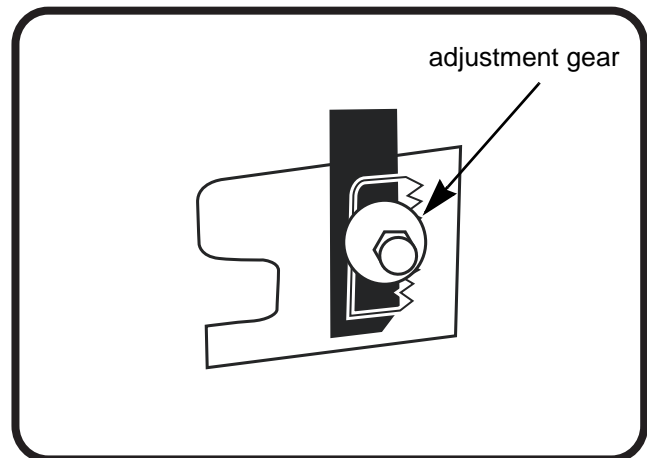

Figure 8.23



Figure 8.24

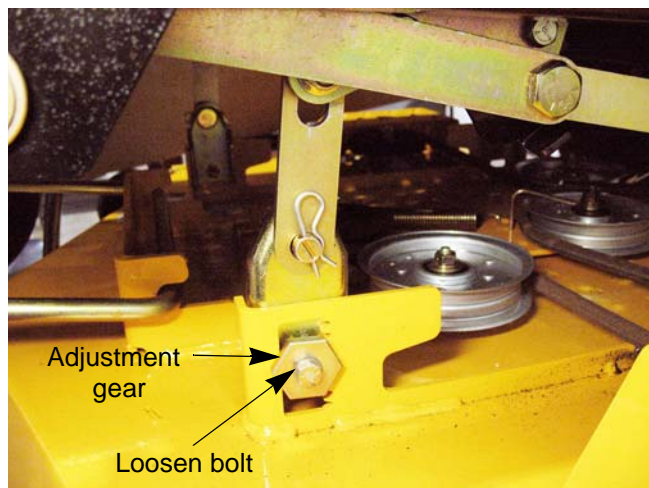

Figure 8.25

- Loosen, but do NOT remove, the hex bolt on the front left deck hanger link. See Figure 8.25.

NOTE: The front right deck hanger link is not adjustable

- To level the deck turn the adjustment gear, located immediately behind the bolt. Turn the gear clockwise (rearward) to raise the left side of the deck. Turn the gear counter-clockwise (toward front) to lower the left side of the deck. See Figure 8.25.
- The deck is properly leveled when both blade tip height measurements, as described earlier, are equal.
- Tighten the bolt on the left deck hanger bracket when proper adjustment is achieved.

Front To Rear (pitch) Leveling



Figure 8.26

- With the mower parked on a firm, level surface, move the deck to the mid height or most commonly used position using the deck lift pedal. Rotate the blade nearest the discharge chute so that it is parallel with the mower frame.

NOTE: Check the mower's tire pressure before performing any deck leveling adjustments. The recommended operating tire pressure is:

- Approximately 10 psi for the rear tires
- Approximately 14 psi for the front tires

- Measure the distance from the front of the blade tip to the ground and the rear of the blade tip to the ground.
- The front measurement taken should be between 1/4" - 3/8" less than the rear measurement. Determine the approximate distance necessary for proper adjustment and proceed, if necessary, to the next step.

- Loosen, but do NOT remove, the hex bolt on the left and right rear deck hanger brackets.
- Raise or lower the left and right side of the deck by turning both of the adjustment gears equally.
- Re-measure the distance from the front of the blade tip to the ground and the rear of the blade tip to the ground.

Z-Force-S

Deck Gauge Wheel Adjustment

The cutting decks are of a “floating” design. This means that they are suspended above the ground. The gauge wheels occasionally touch the ground. They are designed to bump the deck up and over irregularities. This prevents scalping damage to the turf and to the deck.

Adjust the gauge wheels as follows:

1. Place the mower on a smooth, flat surface and move the deck to the desired mowing height using the deck lift pedal.

NOTE: Check the mower’s tire pressure before performing any deck leveling adjustments. The recommended operating tire pressure is:

- Approximately 10 psi for the rear tires
- Approximately 14 psi for the front tires

2. Check gauge wheels distance from the flat surface below. The deck wheels should have between 1/4” - 1/2” clearance above the ground.
3. Remove the shoulder bolt securing the ball wheel to the index bracket.
4. Reposition the ball wheel to align with one of the index holes that places the wheel 1/4” to 1/2” above the ground. See Figure 8.27.
5. Secure the ball wheel to the index bracket with the shoulder bolt.

NOTE: Both front wheels should use the same index hole and both rear wheels should use the same index hole.

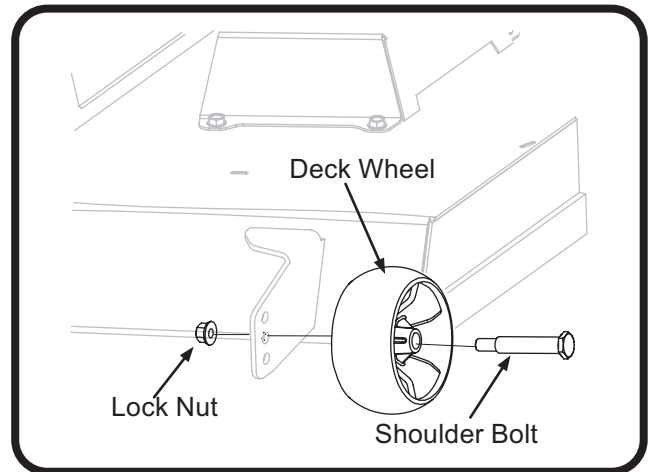

Figure 8.27

Front and rear deck lift shaft assembly

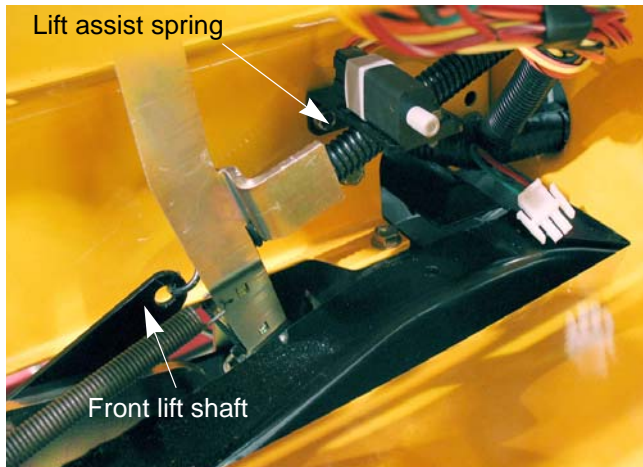

Figure 8.28

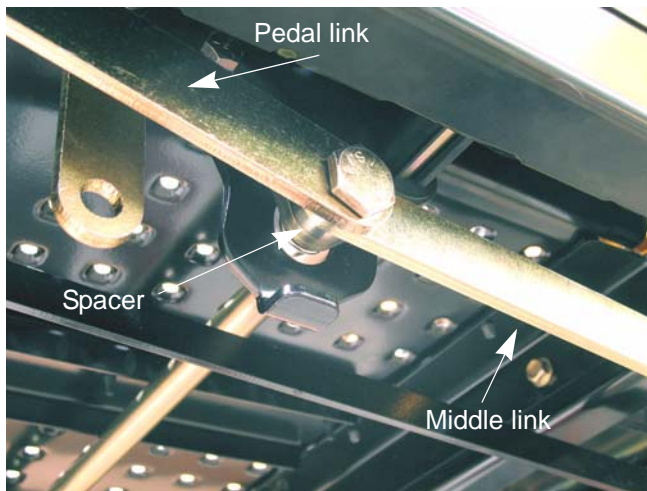

Figure 8.29

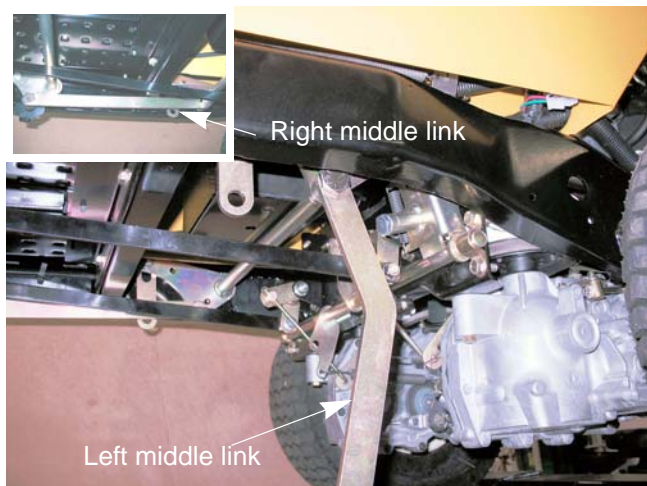

Figure 8.30

The Z-force-S has two deck lift shafts. The same procedure is used to remove either one.

To remove/replace a lift shaft:

1. Remove the deck by following the steps described at the beginning of this chapter.
2. Remove the left control panel by following the steps described in Chapter 4: Body/Chassis.

NOTE: On units equipped with a 60" deck, the right control panel will need to be removed as well.

3. Remove the deck lift assist spring(s). See Figure 8.28.

NOTE: 48" decks use a single deck lift assist spring on the left hand side. 60" decks have a lift assist spring on both sides.

4. Remove the shoulder bolt that connects the pedal link to the front lift shaft and middle link using a 15/16" wrench and a 9/16" wrench. See Figure 8.29.

NOTE: There is a spacer between the middle link and the lift shaft.

5. Remove both middle links using a 15/16" wrench and a 9/16" wrench. See Figure 8.30.

NOTE: The middle link on the left side is angled. The middle link on the right is straight.

Z-Force-S

6. Remove the nut and bolt that attach the drive control links to the drive bell cranks using a pair of 1/2" wrenches. See Figure 8.31.

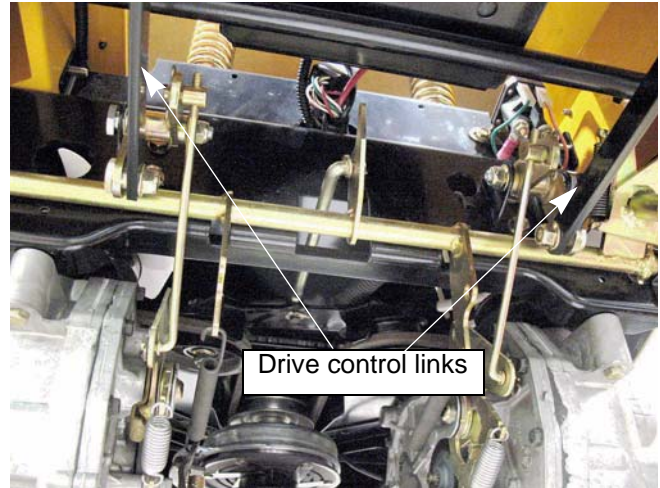

Figure 8.31

7. Remove both of the split spacers from the lift shaft to be removed. See Figure 8.32.

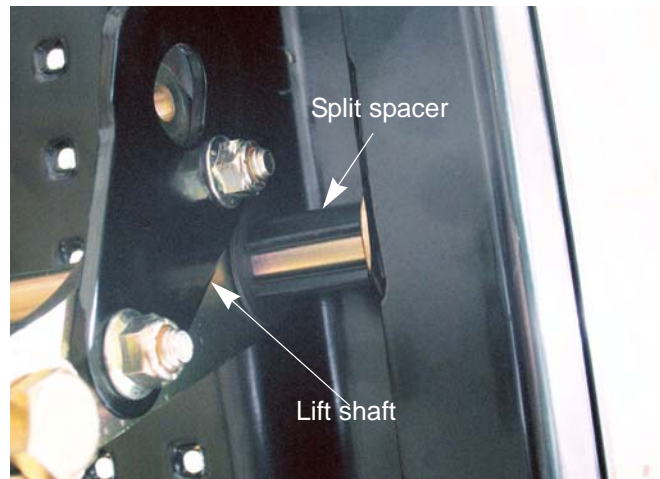

Figure 8.32

8. Slide the lift shaft to one side far enough for the lift shaft and hex bushing to clear the frame. See Figure 8.33.
9. Remove the lift shaft and the other hex bushing from the mower.
10. Install the deck lift shaft(s) and bushings by following the previous steps in reverse order.
NOTE: Do not put grease on the lift shaft or bushings. Grease will hold dirt and accelerate the wear of the bushings.
11. Operate the deck through its full range of travel.
12. Check the deck for levelness and pitch.
13. Test run the mower in a safe area before returning it to service.

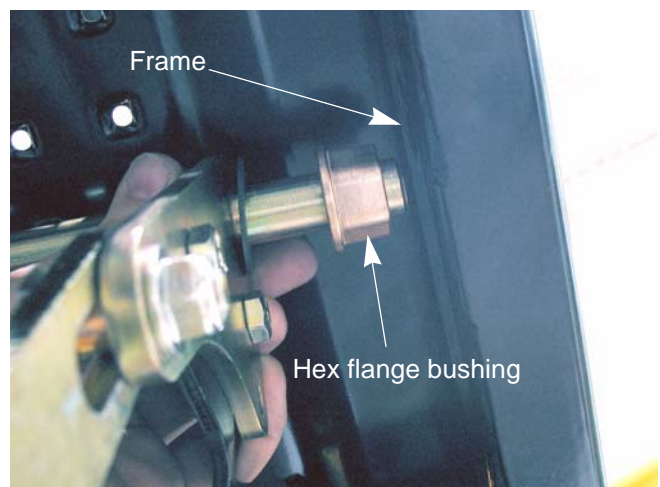

Figure 8.33

Deck lift pedal lever

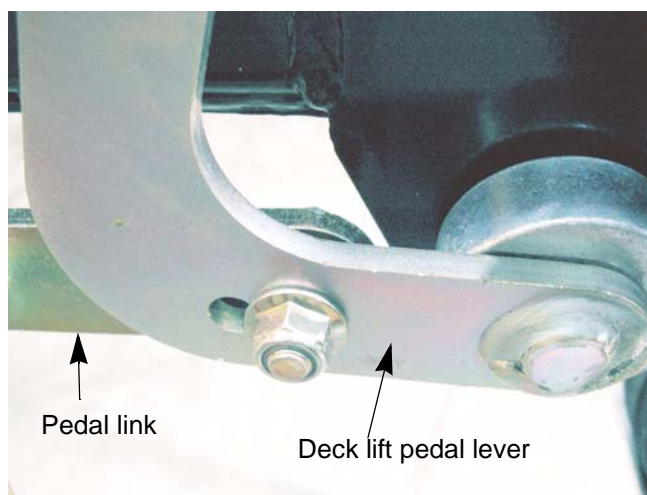

Figure 8.34

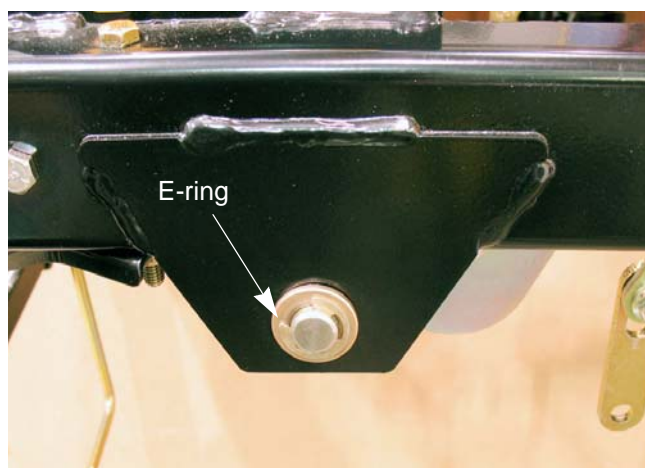

Figure 8.35

To remove/replace the deck lift pedal lever:

1. Remove the floor pan by following the procedures described in Chapter 4: Body.
2. Disconnect the pedal link from the deck lift pedal lever using a 15/16" wrench and a 9/16" wrench. See Figure 8.34.

3. Remove the E-ring that secures the deck lift pedal lever to the frame. See Figure 8.35.
4. Rotate the deck lift pedal lever toward the rear of the mower and slide it out of the frame.
5. Remove the hex flange bushings.

NOTE: The outboard hex flange bushing can be replaced without removing the deck lift pedal lever, but the inboard one can not.

6. Install the deck lift lever pedal by following the previous steps in reverse order.
7. Test run the mower in a safe area before returning it to service.

CHAPTER 9: MAINTENANCE INTERVALS

Lubrication

To help keep the Z-Force-S in proper running order, Cub Cadet recommends the following lubrication intervals be used (adjustable to local conditions). Lubricate with 737-0168 grease or an equivalent NGLI grade 2 lithium based, lead-free multi-purpose non-soap grease.

Lube Point	Number of fittings	Interval
Wheel yokes	2	25 hours
Steering gears	2	25 hours
Front wheel bearings	2	25 hours
Lube pedal pivot points	-	10 hours
Spindles	3	25 hours

NOTE: Lubricate all of the pivot points with a light coating of oil once a season.

NOTE: There are 2 grease fittings on each spindle. Only one needs to be used.

Engine maintenance

The recommended maintenance intervals listed in this manual are a guideline. They are adjustable for local conditions.

Maintenance items	Interval
Oil Change*	100 hrs
Oil filter	200 hours
Clean the air filter	100 hrs
Replace the air filter	200 hrs
Spark plugs	100 hrs
Fuel filter	100 hrs
Clean the engine	100 hours

* First oil change at 8 hours.

Z-Force-S

The spark plugs

The spark plugs should be checked, cleaned and re-gapped on a monthly basis or every 100 hours of use. The plugs should be replaced every six months or 300 hours of use.

When checking the spark plugs, a dry, light colored residue on the plugs is a sign of running lean.

If there is a thick, wet, black residue on the plug the engine is running rich.

There should be a dry tan coating on the plugs. This would indicate the proper mixture.

To remove/replace the spark plugs:

1. Disconnect the spark plug wires on each side. See Figure 9.1.

NOTE: Do not use metal pliers on spark plug wires. Damage to the wire can result.



Figure 9.1

2. Remove the spark plugs with a 13/16" spark plug socket. See Figure 9.2.
3. Clean the Spark plugs with carburetor cleaner or replace them with two NGK BPR4ES spark plugs.

NOTE: Do not clean the spark plugs mechanically (sand blasting or scraping). This will damage the insulator.

4. Gap the electrodes to .030" (.75mm).
5. Thread the spark plugs into the spark plug holes.
6. Tighten the spark plugs to a torque of 16 ft - lbs (22Nm).

NOTE: Refer to the Kawasaki engine manual for more detailed instructions.

7. Push the spark plug wires onto the spark plugs until they snap into place.
8. Test drive the mower in a safe area before returning it to service.



Figure 9.2

Air filter



Figure 9.3



Figure 9.4



Air filter

Figure 9.5

A dirty air filter can reduce engine power, increase fuel consumption and make starting more difficult. The air filter should be cleaned every 100 hours and replaced every 200 hours of use.

To check the air filter:

1. Swing open the air filter cover located at the back of the engine. See Figure 9.3.

2. Loosen the hose clamp on air filter using a 5/16" wrench. See Figure 9.4.

3. Remove the air filter.

4. The air filter can be cleaned by lightly tapping it on a hard surface.

NOTE: Never blow compressed air through a paper air filter. The force of the air moving through the air filter will remove the tiny paper particles that trap the microscopic particles of dirt from the air.

NOTE: The paper element should be white in color. If the dirt does not come out of the filter with gentle tapping, replace the filter.

5. Install the filter by following the previous steps in reverse order.

Z-Force-S

Oil change

The oil change interval is every 100 hrs.

NOTE: The first oil change should be preformed at 8 hours.

To change the oil:

1. Remove the cap from the oil drain. See Figure 9.7.

NOTE: The right rear wheel was removed for a clearer view of the oil drain. It is not necessary to remove the wheel to drain the oil.

2. Remove the dipstick.

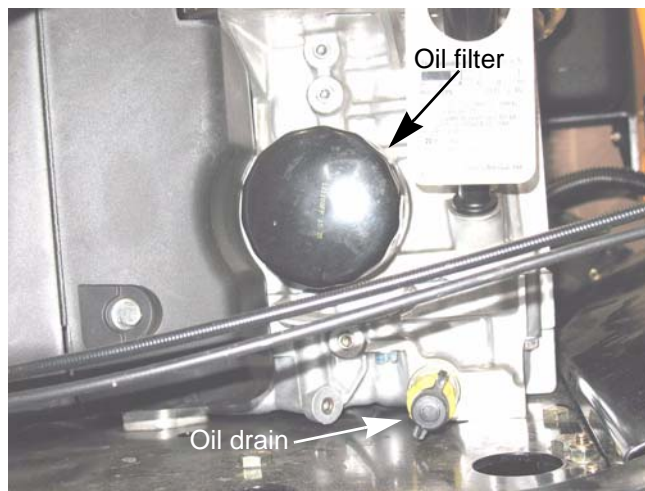

Figure 9.7

3. Slide a piece of 1/2" hose onto the drain.
4. Route the other end of the hose into an approved oil drain pan.

NOTE: The hose can be routed through the hole in the frame to reach the drain pan. See Figure 9.8.

5. Turn the oil drain a quarter turn counter-clockwise to unlock it, then pull out 3/8" (9.5 mm) to open the valve.
6. After all of the oil has been drained, close the oil drain by pushing it in and turning it back a quarter turn.

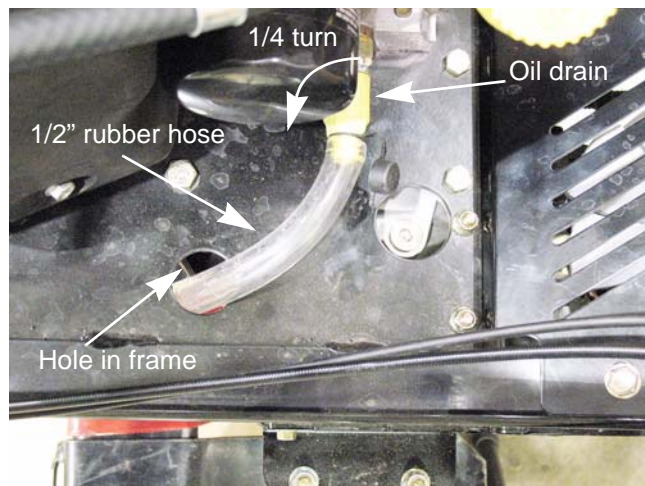
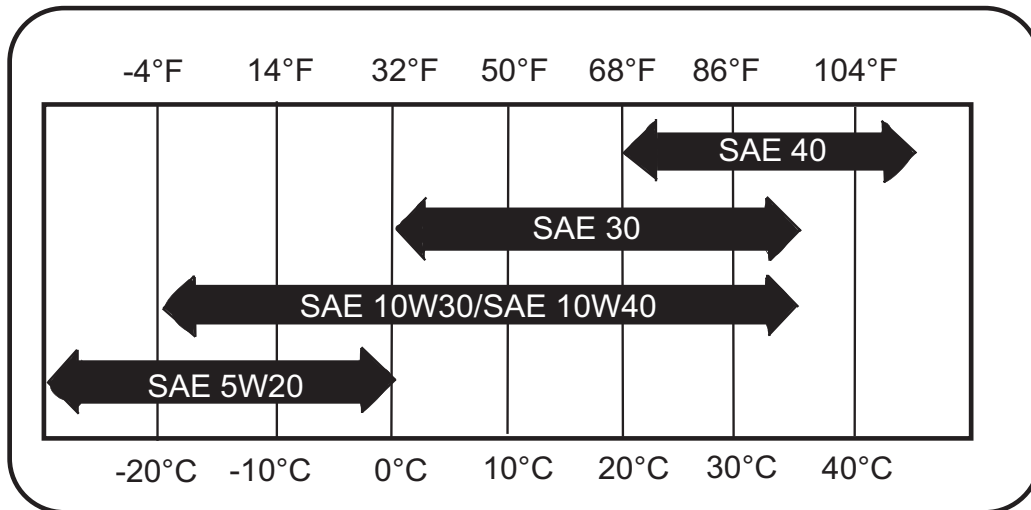

Figure 9.8

7. Remove the drain hose.
 8. Place the cap back on the oil drain.
 9. Fill engine with new oil. Use a good quality oil motor oil that meets the specifications recommended by Kawasaki.
- NOTE:** Refer to the oil chart to determine the proper weight of oil to use.
10. Check the dip stick to verify that the oil is at the proper level before returning to service.

Engine Oil Capacity

Oil filter was not removed	1.9 US qt. (1.8L)
Oil filter was removed	2.2 US qt. (2.1L)



Oil Chart

Oil filter

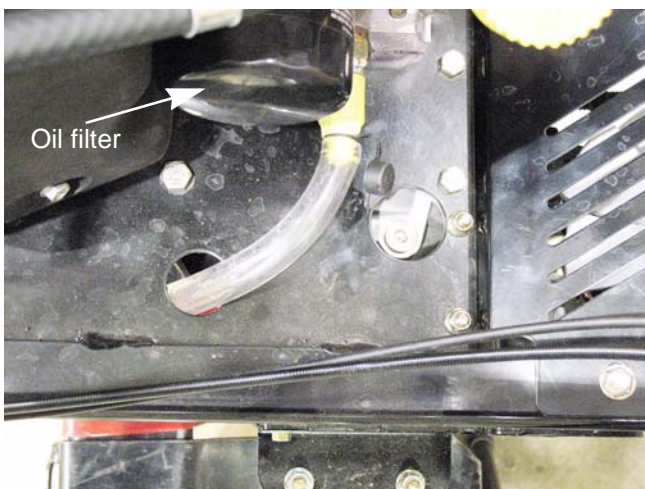

Figure 9.9

To replace the oil filter:

1. Drain the oil by following the steps described in the previous section of this chapter.

NOTE: If replacing a damaged filter, the filter can be removed without draining the oil.

2. Clean the area around the oil filter
3. Remove the oil filter by turning it counter-clockwise, as seen from the right side of the mower. See Figure 9.9.
4. Place a light coating of oil on the O-ring of the new filter.
5. Pre-fill the new filter with fresh, clean oil.
6. Thread the new filter on to the engine. Hand tighten only.
7. Fill the engine with oil.
8. Test run the engine and check for leaks before returning the mower to service.

Z-Force-S

Fuel system

What you should know about fuel.

Most of the fuel presently available in North America is oxygenated to some extent. This is commonly done through the addition of ethanol. Most engines offered for sale on outdoor power equipment in the North American markets are designed to tolerate no more than 10% ethanol by volume

Ethanol is hygroscopic, meaning it absorbs water. If left exposed to air, it will draw water out of the air.

Ethanol is an oxygenator, which means that it will oxidize (corrode) metal that it comes into contact with. Exposure to air causes fuel to go bad quickly, leaving gum and varnish deposits.

Methanol is another type of alcohol that is used to oxygenate fuel. Fuel that contains 5% methanol can be used as long as it also contains cosolvents and corrosion inhibitors to protect the fuel system. Fuel with more than 5% methanol will cause starting and/or performance problem. It will also cause damage to the metal, rubber and plastic components of the fuel system.

Fuel used in Cub Cadet outdoor power equipment should be no more than 30 days old. Because it may already have been stored at the refinery or gas station for a week or more, fuel should be purchased in small quantities and stored in safety approved gas cans with the caps closed.

For storage, all fuel should be run out of the tank and engine. Anti-oxidation additives will help keep the fuel fresher.

Servicing the fuel system

Inspect the fuel system every time the mower is operated. If dirty fuel is found in the fuel tank or fuel that does not smell "right", drain the fuel tank and replace the fuel filter

Drain the fuel tank by removing the fuel line from the fuel filter and drain the fuel into an empty safety approved gas can. Dispose of the bad fuel in a safe, responsible and legal manner.



Gasoline and its vapors are extremely flammable. Use common sense when working around the fuel system. Avoid sparks, open flames or heat sources that can ignite the fuel vapors.

Fuel filter

A dirty fuel filter can result in a lean run condition. The fuel filter should be replaced every 100 hours.

To replace the fuel filter:

NOTE: Only use the OEM fuel filter, part number KM-49019-7005.

1. Clamp off the fuel lines to prevent fuel from leaking when the lines are disconnected. See Figure 9.10.

IMPORTANT: Take care that the fuel lines are not damaged when clamping them off. Never insert a screw or anything else into the fuel line to prevent fuel from coming out. This will damage the inside of the fuel line.

NOTE: There are commercially available fuel line clamping tools that will not damage the fuel lines.

2. Squeeze the tabs on the fuel line clamps and slide them away from the filter.



Figure 9.10

Maintenance Intervals

- Carefully slide the fuel lines off of the filter. If there are pieces of rubber on the barbs of the fuel filter, replace the affected fuel line.
IMPORTANT: The Z-Force-S uses low permeation fuel line to meet EPA guidelines. When replacing the fuel lines, they must be replaced with the same type of low permeation fuel line.
- Install the new filter by following the above steps in reverse order.
- Test run the engine and check for leaks before returning to service.

Clean the engine

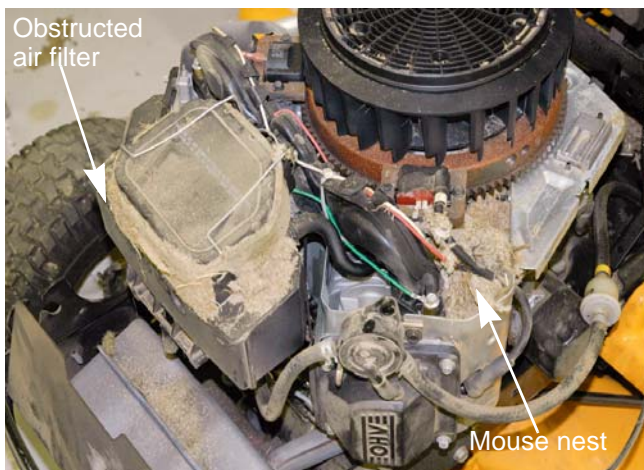

Figure 9.11

Air cooled engines cool better if they are clean. Check for nesting or signs of nesting especially after dormant season storage. See Figure 9.11.

Transmissions



Figure 9.12

The Z-Force S has two options for transmissions. The 48" deck version is equipped with two HydroGear EZT transmissions. The 60" version is equipped with two ZT2800 transmissions.

The maintenance procedures for the transmissions are located in the HydroGear manuals. The Hydro-gear shop manual for the EZT transmissions is form number BLN-52622. The Hydro-gear shop manual for the ZT2800 transmissions is form number BLN-52441.

NOTE: The ZT2800 transmissions have an expansion tank mounted in front of the engine. When the transmissions are cold, the tank should be empty.

